

**PLEASANT VALLEY RECREATION & PARK DISTRICT
SENIOR CENTER at COMMUNITY CENTER PARK
1605 E. BURNLEY ST., CAMARILLO, CALIFORNIA**

**BOARD OF DIRECTORS
REGULAR MEETING AGENDA (amended on May 1, 2024)
May 1, 2024**

This meeting will take place both in person and remotely in accordance with Government Code section 54953(e) *et seq.* (AB 2449). Members of the public can observe and participate in the meeting as follows:

1. Zoom Meeting Information:

Meeting Link:

[https://us06web.zoom.us/j/85836524438?pwd=WA2pAccCTrQaKK552HRXJuBRSwawvY.](https://us06web.zoom.us/j/85836524438?pwd=WA2pAccCTrQaKK552HRXJuBRSwawvY.1)

1

Webinar ID: 858 3652 4438

Phone Number: 1-669-900-6833

Passcode: 395142

- a. Cell Phone/Computer with Microphone: Click on the Zoom webinar link included above. Enter your name so we may call on you when it is your turn to speak. The Chair will ask if anyone wishes to speak on the item. At that time, raise your hand by clicking the “Raise Hand” button. Follow the instructions below regarding speaking.
- b. Phone – If you wish to make a comment by phone during the public comment section of the meeting or on a specific agenda item, please call into the listed phone number above and when prompted, enter the Webinar ID and Passcode. After entering those items, you will be admitted to the meeting and your line will be muted. The Chair will ask if anyone wishes to speak on the item. At that time, raise your hand by dialing *9. Then, follow the speaking instructions below.

Speaking Instructions

When it is your turn to speak, the Chair will call your name or the last four digits of the phone number you are calling from. You will have three minutes to address the Committee. **Please ensure all background noise is muted (TV, radio, etc.)** You will be prompted to unmute your microphone/phone. Unmute your device and begin by stating your name. After three minutes has elapsed your microphone will be muted, and the next speaker will be invited to speak.

5:00 P.M.

REGULAR MEETING

NEXT RESOLUTION #763

1. CALL TO ORDER

A. Open Meeting and Recess to Closed Session

B. Closed Session

i. Conference with Labor Negotiations

The Board will conduct a closed session, pursuant to Govt. Code Section 54957.6, with the District’s negotiators, Mary Otten, Kathryn Drewry, Justin Kiraly and Board Counsel, regarding labor negotiations with the employee organization, SEIU Local 721.

C. Reconvene into Regular Meeting

2. PLEDGE OF ALLEGIANCE

3. ROLL CALL

4. **AMENDMENTS TO THE AGENDA** - This is the time and place to change the order of the agenda, delete any agenda item(s), or add any emergency agenda item(s).
5. **PUBLIC COMMENT** - In accordance with Government Code Section 54954.3, the Board reserves this time to hear from the public. If you would like to make comments about a matter within the Board's subject matter jurisdiction but not specifically on this agenda, in accordance with California law, the Board will listen, note the comments, and may bring the comments back up at a later date as an agenda item for discussion. Speakers will be allowed three minutes to address the Board.
6. **CONSENT AGENDA** – Matters listed under the Consent Agenda are considered routine and shall be acted upon without discussion and by one motion. If discussion is desired, the item will be removed from the Consent Agenda for discussion and voted on as a separate item. If no discussion is desired, then the suggested action is for the Chair to request that a motion be made to approve the Consent Agenda.
 - A. **Minutes for Regular Board Meeting of April 3, 2024**
Approval receives and files minutes.
 - B. **Warrants, Accounts Payable & Payroll**
District's disbursements dated on or before March 31, 2024.
 - C. **Financial Reports**
Monthly unaudited financial reports are presented to the Board for information. Approval receives and files the financial reports for March 2024.
 - D. **Consideration and Adoption of Resolution No. 760 Declaring Intention To Levy Assessments for FY 2024-2025, Preliminarily Approving the Engineer's Report, and Authorizing the Issuance of a Notice for the Public Hearing for the Proposed FY 2024-2025 Assessments for the Park Maintenance and Recreation Improvement District for the Pleasant Valley Recreation and Park District**
Preliminary approval of the Engineer's Report and establishment of the hearing date allows for the development of the proposed budget and assessment rate.
 - E. **Consideration and Adoption of Resolution No. 761, Expanding the Paid Sick Leave Policy in the 2022 Personnel Policy Manual**
Senate Bill No. 616 went into effect on January 1, 2024, expanding paid sick leave for California employers and employees from three days or twenty-four hours to five days or forty hours, whichever is more.
 - F. **Consideration and Adoption of Resolution No. 762, Adding Reproductive Loss Leave to the Family Care and Medical Leave Policy in the 2022 Personnel Policy Manual**
Senate Bill 848, effective January 1, 2024, entitles eligible employees to five (5) days of leave following a reproductive loss event.
 - G. **Consideration and Approval to Extend the Tree Trimming Contract between the District and West Coast Arborist for a Term of One Year**
This will be the third and final one-year extension of the 2017 Agreement with West Coast Arborist for tree trimming services for the District.
7. **NEW ITEMS – DISCUSSION/ACTION**
 - A. **Consideration and Acceptance of SitelogIQ Project Scope and Direction for Staff to Proceed with A Public Hearing for Renewable Energy and Energy Efficiency Upgrades to District Facilities**

SitelogIQ, Inc. has completed their District-wide audit of facilities and parks to develop an energy efficiency program. Based on these results, Staff is prepared to enter into an agreement for the energy efficiency program to assist the District with renewable energy initiatives.

Suggested Action: A MOTION to Consider and Accept the project and direct Staff to work with SitelogIQ, Inc. on a Notice of a Public Hearing, to be read at the District's Board of Directors Meeting on June 5, 2024.

B. Consideration and Approval of the Design and Construction Plans from kidSTREAM for the Shared Parking Lot Expansion at Bob Kildee Community Park on the Eston Street Side

Staff is seeking approval of design and construction plans for the parking lot expansion as a part of the approved 2022 kidSTREAM Parking Agreement.

Suggested Action: A MOTION to Consider and Approve the proposed design and construction plans for the kidSTREAM expanding parking lot on the Eston Street side at Bob Kildee Community Park.

C. Consideration and Approval of the Design of the Playground and Fitness Equipment for Lokker Park

The District allocated \$500,000 in the FY 2023-2024 Capital Budget to replace the playground at Lokker Park. After multiple public engagement meetings, landscape architects Jordan & Bain have three design options for the Board to choose from.

Suggested Action: A MOTION to Consider and Approve Design Option #1 for playground replacement and site enhancements at Lokker Park.

D. Consideration and Approval of Design Option for the Community Center Auditorium Stage ADA Improvements

As requested at the April 3, 2024, Board meeting, Staff is presenting pricing of a fourth design option of an inclined stair lift for consideration to improve the Auditorium Stage for increased ADA accessibility.

Suggested Action: A MOTION to Consider and Recommend a design option for Staff to provide direction to staff and the Lauterbach & Associates, Inc. team for the Community Center Auditorium ADA Stage improvements.

8. PUBLIC HEARING

A. Approval of a First Reading for the Adoption of Ordinance No. 14, an Ordinance of the Board of Directors of the Pleasant Valley Recreation and Park District Setting Board Member Compensation

Staff is recommending the Board approve the first reading of Ordinance No. 14, to set compensation for members of the Board of Directors.

Suggested Action: A MOTION to Review and Introduce Ordinance No. 14 by:

1. Making a MOTION to read the complete Ordinance No. 14 title - *Ordinance No. 14, An Ordinance of the Board of Directors of the Pleasant Valley Recreation and Park District Setting Board Member Compensation* and to waive further reading;

AND

2. Making a MOTION to APPROVE the introduction and first reading of the District's *Ordinance No. 14, An Ordinance of the Board of Directors of the Pleasant Valley Recreation and Park District Setting Board Member Compensation.*

9. ORAL COMMUNICATION – INFORMATIONAL ITEMS, which do not require action but relate to District Business, will be reported by members of the Board and staff as follows:

- A. Chair Malloy**
- B. Ventura County/California Special District Association**
- C. Santa Monica Mountains Conservancy**
- D. Standing Committees – Finance, Policy**
- E. Foundation for Pleasant Valley Recreation and Parks**
- F. General Manager's Report**
- G. Board Members**

10. ADJOURNMENT

Notes: The Board of Directors reserves the right to modify the order in which agenda items are heard. Written materials related to these agenda items are available for public inspection in the Office of the Clerk of the Board located at 1605 E. Burnley Street, Camarillo during regular business hours beginning the Friday preceding the Wednesday Board meeting.

Announcement: Public Comment: Members of the public may address the Board on any agenda item before or during consideration of the item. [Government Code section 54954.3] Should you need special assistance (i.e., a disability-related modification or accommodations) to participate in the Board meeting or other District activities (including receipt of an agenda in an appropriate alternative format), as outlined in the Americans With Disabilities Act, or require further information, please contact the General Manager at 482-1996, extension 114. Please notify the General Manager 48 hours in advance to provide sufficient time to make a disability-related modification or reasonable accommodation.

<https://us06web.zoom.us/j/85836524438?pwd=WA2pAccCTrQaKK552HRXJuBRSwawvY.1>

**Pleasant Valley Recreation and Park District
Community Center – Senior Center Building
Minutes of Regular Meeting
April 3, 2024**

6:00 P.M.

REGULAR MEETING

1. CALL TO ORDER

2. PLEDGE OF ALLEGIANCE

3. ROLL CALL

All present.

4. AMENDMENTS TO THE AGENDA

Chair Malloy called for a motion. A motion was made by Director Magner seconded by Director Roberts to accept the agenda as presented.

**Motion to
Approve
Agenda as
Presented**

Voting was as follows:

Ayes: Magner, Roberts, Dransfeldt, Kelley, Chair Malloy

Noes:

Absent:

Motion: Carried

Carried

5. PRESENTATIONS

A. Volunteer of the Year

Development Analyst Kaleen Gage presented Aruna Pandurangan with a plaque to acknowledge her as the District's Volunteer of the Year - 2023. Ms. Pandurangan has volunteered at 7 District events and 51 Food Distribution days, logging 136 hours in 2023.

6. PUBLIC COMMENT

No general public comments.

7. CONSENT AGENDA

A. Minutes for Regular Board Meeting of March 6, 2024

B. Warrants, Accounts Payable & Payroll

C. Financial Reports

D. Consideration and Adoption of Resolution No. 759 Proclaiming April 2024 as Arbor Month

E. Consideration and Approval of Rejection of Bid Award and Re-advertisement of Request for Proposals for Consulting Services for the Comprehensive Parks and Recreation Master Plan

F. Consideration and Approval of Renewal of Agreement with Amilia Technologies USA, Inc. for SmartRec Online Registration Software

Director Roberts requested that Item 7.F. *Consideration and Approval of Renewal of Agreement with Amilia Technologies USA, Inc. for SmartRec Online Registration Software* be pulled for discussion. Mr. Roberts questioned Administrative Services Manager Justin Kiraly about the steep increase in the new contract amount. Mr. Kiraly stated that the cost increase is based on a percentage of increased revenue projected for the next few years from increased registration and rental transactions.

Chair Malloy called for a motion. A motion was made by Director Roberts and seconded by Director Dransfeldt to approve the Consent Agenda.

Motion to Approve Consent Agenda

Voting was as follows:

Ayes: Roberts, Dransfeldt, Kelley, Magner, Chair Malloy

Noes:

Absent:

Carried

Motion: Carried

8. NEW ITEMS – DISCUSSION/ACTION

A. Consideration and Approval of Updated Turf Policy Revisions

Park Services Manager Matt Parker presented revisions for the Sports Turf Policy, highlighting 6 main changes within two different sections of the policy. The changes included no fueling on turf; moving AR lines periodically; updating the field misuse contact number; updating the emergency contact number; no games before 9am on frost advisory days; and the need for tournaments with over 110 teams to obtain the General Manager’s approval with a minimum of 30 days’ notice.

Dan Johnston with AYSO stated that they have been complying with all the changes including fee increases and decreased turf time and stated that normal use is not what is damaging the fields. He questioned the AR line revision because there is no damage, the frost policy and the parking issues which happen infrequently out at PV Fields.

Jennette Rossling with AYSO asked if the tournaments scheduled for 2024 (2 in May and 1 in September) be grandfathered in as they will have 120 teams and not much time to make changes. Mrs. Rossling also asked that the definition of ‘teams’ be clarified because age matters on the number of people and the size of the fields. Mrs. Rossling thanked staff for their assistance during the rainy season.

Discussion included: the need to address parking issues at PV Fields due to infill and neighboring businesses; the number of 12 players as a rough estimate for a team; AYSO’s contact with Rancho Rosal School, the YMCA and local businesses regarding parking and ADA compliance of adjacent gates; consideration of shuttles, park and ride drop off zones and carpools to alleviate parking issues; and the need for a parking plan in place by September of this year.

Chair Malloy called for a motion. A motion was made by Director Roberts and seconded by Director Magner to approve the suggested amendments (#1 through #6) from the updated Sports Turf Policy to be effective immediately with a waiver for the two upcoming AYSO tournaments in May 2024.

Motion to Approve Turf Policy Updates Along with a Waiver

Voting was as follows:

Ayes: Roberts, Magner, Dransfeldt, Kelley, Chair Malloy

Noes:

Absent:

Carried

Motion: Carried

B. Consideration and Approval of Design Option for the Community Center Auditorium Stage ADA Improvements

Park Services Manager Matt Parker presented updated options with pricing for a wheelchair lift for the Auditorium stage. Everett Scofield with Lauterbach & Associates, Inc. (architects) was present in the audience. Discussion included: preference of option #2 as the best compromise for privacy and cost; the need to retain use of the staircase; and the need to find out costs for an incline stair wheelchair lift. Direction was made for staff to research the costs and commercial functionality of the incline stair wheelchair lift and to bring back information for the May Board Meeting.

Staff Direction

C. Consideration and Approval of Bid Award for the Pool Deck Resurfacing at the Pleasant Valley Aquatic Center

Park Services Manager Matt Parker presented consideration of a bid award to MDJ Management, LLC. to resurface the pool deck in May 2024.

Chair Malloy called for a motion. A motion was made by Director Magner and seconded by Director Dransfeldt to approve the General Manager to enter into a cooperative purchasing agreement with MDJ Management, LLC., a Sourcewell contractor for the resurfacing of the pool deck for an amount not to exceed \$54,437.

Motion to Approve Resurface of Pool Deck

Voting was as follows:

Ayes: Magner, Dransfeldt, Roberts, Kelley, Chair Malloy

Noes:

Absent:

Carried

Motion: Carried

9. ORAL COMMUNICATION - INFORMATIONAL ITEMS

A. Chair Malloy – Chair Malloy updated on the meetings and District events that he attended in March. He mentioned that the Lokker Park playground estimates were too high, but he hoped that the item would be on the agenda for May.

B. Ventura County/California Special District Association – VCSDA - Director Magner reported that she, Director Malloy, and General Manager Mary Otten attended the most

recent VCSDA meeting. CSDA – Director Magner stated that the organization is following many bills, collecting info for lobbyists, and she presented a Legislator of the Year award to Assemblymember Gregg Hart in Montecito.

C. Santa Monica Mountains Conservancy – Director Dransfeldt stated that the March 15 meeting was cancelled, and the next meeting is April 8 at King Gillette Ranch in Calabasas.

D. Standing Committees – Finance – Director Malloy updated on revenues and expenses and reported 3 payrolls in February. Personnel – Director Malloy stated the committee covered changes to the District’s sick leave policy and discussed reproductive loss leave.

E. Foundation for Pleasant Valley Recreation and Parks – Director Dransfeldt stated there will be a fundraiser at Blvd Burger on May 1 and the group is hosting a cornhole tournament at Summer Palooza in June. The Nature Education Building is now painted, and the Foundation will be hosting a grand opening as part of the April 20 *Love Your Planet* event at Camarillo Grove Park.

F. General Manager’s Report – General Manager Mary Otten reported on current projects and studies that staff are working on along with programs and special events. Ms. Otten updated the Board regarding the building of the Freedom Park Pickleball Complex. A traffic study will not be needed, but the District will be in discussions with the City regarding power lines. Ms. Otten clarified questions the Board has received from the community regarding parking for the Greek Festival which is now being held at the St. Demetrios Greek Orthodox Church on Santa Rosa Road. The lots at the airport which have numerous vehicles parked are on county property and do not belong to the District. The District’s parking lots are at Freedom Center and on the west end of the park near the new dog park. The church has stated that they are looking to shuttle people from the Ventura County Office of Education on Adolfo Road to their church property for the festival.

G. Board Members – The Directors updated staff on the meetings and District events they attended for the month.

9. ADJOURNMENT

Chair Malloy adjourned the meeting at 7:51 p.m.

Respectfully submitted,

Karen Roberts
Recording Secretary

Approval,

Mark Malloy
Chair

CASH REPORT

	3/31/2024 Balance	3/31/2023 Balance
Debt Service - Restricted	\$ 150,834.61	\$ 142,672.73
457 Pension Trust Restricted	\$ 73,330.40	\$ 69,415.96
Cal CLASS/PW Quimby Fee - Restricted	\$ 4,451,343.96	\$ 1,354,268.00
VC Pool Quimby- Restricted	\$ 2,655,096.08	\$ 5,670,476.03
Park Impact Fees	\$ 2,105,686.80	\$ 190,700.83
Miracle League 805	\$ -	\$ 1,309,519.59
FCDP Checking	\$ 13,846.66	\$ 13,601.16
Total	\$ 9,450,138.51	\$ 8,750,654.30

Semi-Restricted Funds

Assessment	\$ 1,004,620.96	\$ 921,827.25
LAIF - Capital	\$ 1,454,708.41	\$ 1,363,646.39
PacWest/CalCLASS - Capital	\$ 1,963,636.76	\$ 1,854,458.17
Designated Project	\$ 230,484.00	\$ 230,484.00
Capital Reserves	\$ 500,000.00	\$ 500,000.00
Capital - Vehicle Replacement	\$ 49,843.80	\$ 49,843.80
Contingency - Dry Period	\$ 467,337.09	\$ 462,337.09
Contingency - Computer	\$ 33,000.00	\$ 25,000.00
Contingency - Repair/Oper/Admin	\$ 420,000.00	\$ 320,000.00
Contingency - Compensated Absences	\$ 125,000.00	\$ 100,000.00
Contingency - Vehicle Replacement	\$ 45,000.00	\$ 30,000.00
Total	\$ 6,293,631.02	\$ 5,857,596.70

Unrestricted Funds

Contingency	\$ 5,445,853.65	\$ 4,021,689.67
General Fund Checking	\$ 293,445.75	\$ 216,001.00
Total	\$ 5,739,299.40	\$ 4,237,690.67

Total of all Funds

	\$ 21,483,068.93	\$ 18,845,941.67
--	-------------------------	-------------------------

	4/10/2024 Balance	4/30/2023 Balance
--	----------------------	----------------------

Debt Service - Restricted	\$ 150,834.61	\$ 143,227.59
457 Pension Trust Restricted	\$ 73,330.40	\$ 69,683.14
Cal CLASS/PW Quimby Fee - Restricted	\$ 4,451,317.16	\$ 1,355,364.69
VC Pool Quimby- Restricted	\$ 2,655,096.08	\$ 5,670,476.03
Park Impact Fees	\$ 2,105,686.80	\$ 191,629.55
Miracle League 805	\$ -	\$ 1,311,577.49
FCDP Checking	\$ 13,846.66	\$ 13,601.16
Total	\$ 9,450,111.71	\$ 8,755,559.65

Semi-Restricted Funds

Assessment	\$ 987,961.69	\$ 1,260,875.78
LAIF - Capital	\$ 1,454,708.41	\$ 1,363,646.39
PacWest/CalCLASS - Capital	\$ 1,963,636.76	\$ 1,861,880.11
Designated Project	\$ 230,484.00	\$ 230,484.00
Capital Reserves	\$ 500,000.00	\$ 500,000.00
Capital - Vehicle Replacement	\$ 49,843.80	\$ 49,843.80
Contingency - Dry Period	\$ 467,337.09	\$ 462,337.09
Contingency - Computer	\$ 33,000.00	\$ 25,000.00
Contingency - Repair/Oper/Admin	\$ 420,000.00	\$ 320,000.00
Contingency - Compensated Absences	\$ 125,000.00	\$ 100,000.00
Contingency - Vehicle Replacement	\$ 45,000.00	\$ 30,000.00
Total	\$ 6,276,971.75	\$ 6,204,067.17

Unrestricted Funds

Contingency	\$ 5,145,853.65	\$ 6,456,985.98
General Fund Checking	\$ 483,222.22	\$ 479,591.41
Total	\$ 5,629,075.87	\$ 6,936,577.39

Total of all Funds

	\$ 21,356,159.33	\$ 21,896,204.21
--	-------------------------	-------------------------

Pleasant Valley Recreation and Park District
 Monthly AP, Payroll, Wire, Online Payment Report
 March 2024

	Date	Amount	
Accounts Payables:	3/31/2024	\$ 526,046.91	
	Total	\$ 526,046.91	
Payroll (Total Cost):	3/14/2024	\$ 160,123.49	
	3/28/2024	\$ 156,716.81	
	Total	\$ 316,840.30	
Payroll AP Payments	3/4/2024	\$ 43,386.26	PERS Health Insurance Premium
	3/4/2024	\$ 3,827.12	Guardian
	3/4/2024	\$ 646.35	VSP
	3/4/2024	\$ 1,889.72	Hartford
	3/14/2024	\$ 17,350.36	CALPERS - Ret PR 3/14/2024
	3/28/2024	\$ 17,319.57	CALPERS- Ret-PR-3/28/2024
	Total	\$ 84,419.38	
	Grand Total	\$ 927,306.59	

Developer	Project			Quimby Funds			GL Code			
	No.	Location	Description	Budgeted	Expended	Awarded		Balance	Committed Date	Allocation Date
AMLI										
Public Hearing 7/5/2018	1	Nancy Bush	Nancy Bush Picnic Area(s)	\$ 45,600.00	\$ 29,585.62	\$ 615,709.00	\$ 615,709.00		7/31/2019	8446
Public Hearing 7/5/2018	2	Valle Lindo	Valle Lindo RR/Pavillion*	\$ 425,000.00	\$ 364,574.44	\$ 8444	\$ 8444		12/6/2018	8444
Public Hearing 7/5/2018	3	Nancy Bush	Nancy Bush Playground	\$ 250,000.00	\$ 221,548.94	\$ -	\$ -		10/3/2018	8445
TOTALS				\$ 720,600.00	\$ 615,709.00	\$ -	\$ -			
*Amount allocated exceeds fee total due to Valle Lindo Restroom Project, excess expenses to be allocated from KB Homes										
FAIRFIELD LLC										
Public Hearing 11/7/2018	1	Freedom	Freedom Baseball Fields- Non-Contract Cost	\$ 1,100,000.00	\$ 504,121.78	\$ 2,250,489.70	\$ 2,250,489.70		1/31/2020	8459
	2	Freedom	Freedom Baseball Fields- Contract Cost	\$ 500,000.00	\$ 411,628.87	\$ 1,746,367.92	\$ 1,746,367.92		11/7/2018	8459
Public Hearing 7/3/19	3	PVAC	PVAC Restrooms and Showers	\$ 500,000.00	\$ 647,336.74	\$ 687,402.31	\$ 687,402.31			8469
Mid-Year Budget Adj. 2/5/2020	4	PV Fields	Fertilizer Injector System	\$ 60,000.00	\$ 50,788.90	\$ 636,613.41	\$ 636,613.41			8478
	5		Senior and Community Rec Fee Project	\$ -	\$ -	\$ 636,613.41	\$ 636,613.41			
	6		Senior and Community Rec Fee Exterior Proj	\$ -	\$ -	\$ 636,613.41	\$ 636,613.41			
	7		Community Center Kitchen Expansion	\$ 250,000.00	\$ 280,649.20	\$ 355,964.21	\$ 355,964.21			8480
	8		Community Center Classroom and Auditorium Enhancements	\$ -	\$ -	\$ -	\$ -			
	9		Freedom Park Parking Lot Enhancement	\$ -	\$ -	\$ -	\$ -			
	10		Freedom Park Landscape and Walking Path	\$ -	\$ -	\$ -	\$ -			
	11		Camarrillo Grove Nature Center	\$ -	\$ -	\$ -	\$ -			
ELACORA MISSION OAKS										
Budget Allocation 11/5/2020	1	Encanto	PG Equipment Installation	\$ 1,500,000.00	\$ 189,887.74	\$ 2,649,209.00	\$ 2,649,209.00		8/8/2021	
Budget Allocation 7/7/2021	2	Arnell Rch Pk	Arnell Ranch Park Renovation	\$ 1,400,000.00	\$ 1,496,641.96	\$ 962,679.30	\$ 962,679.30		11/3/2016	8464
	3		Pickleball	\$ 300,000.00	\$ 293,635.95	\$ 669,043.35	\$ 669,043.35		11/5/2020	8493
	4		Camarrillo Nature Center	\$ -	\$ -	\$ 669,043.35	\$ 669,043.35			
	5		Freedom Park Landscape and Walking Path	\$ -	\$ -	\$ 669,043.35	\$ 669,043.35			
			Freedom Baseball Fields	\$ -	\$ -	\$ 669,043.35	\$ 669,043.35			
KB HOMES										
Public Hearing 7/5/2018	1	Valle Lindo	Valle Lindo RR/Pavillion*	\$ 425,000.00	\$ 32,368.30	\$ 474,353.00	\$ 474,353.00		8/10/2021	8444
Public Hearing 7/5/2018	2	Mel Vincent	Mel Vincent Park Restrooms	\$ 139,500.00	\$ 166,253.78	\$ 275,730.92	\$ 275,730.92			8460
Public Hearing 7/5/2018	3	Nancy Bush	Nancy Bush Pavillion	\$ 65,000.00	\$ 31,537.74	\$ 244,193.18	\$ 244,193.18			8447
	4		Community Center Classroom and Auditorium Enhancements	\$ -	\$ -	\$ 244,193.18	\$ 244,193.18			
	5		Dos Caminos Expansion and ADA	\$ -	\$ -	\$ 244,193.18	\$ 244,193.18			
CRESTVIEW										
Public Hearing 6/7/2023	1	Senior/Community Center ADA	Senior/Community Center ADA	\$ 21,612.25	\$ 20,838.17	\$ 21,612.25	\$ 21,612.25		6/7/2023	8510
HABITAT FOR HUMANITY										
Public Hearing 3/6/2024	1	Community Center Improvements	Community Center Improvements	\$ 35,242.00	\$ -	\$ 35,242.00	\$ 35,242.00		9/17/2024	
	2	Freedom Pickleball Courts	Freedom Pickleball Courts	\$ 35,242.00	\$ -	\$ 35,242.00	\$ 35,242.00			
SHEA HOMES										
Public Hearing 7/5/2023	1	Multi-Generation Center	Multi-Generation Center	\$ 1,000,000.00	\$ -	\$ 1,264,500.00	\$ 1,264,500.00		11/21/2024	8504
Williams Homes										
Somis Ranch Phase 1										
Somis Ranch Phase 2										
Barry 60 LP										
Interest										
Grand Total				\$ 7,552,196.25	\$ 4,741,398.13	\$ 11,847,838.17	\$ 7,106,440.04			

Pleasant Valley Recreation and Park District
Park Impact Fee's Collected

FY2022

Date Received	Amount	Applicant	Project
10/28/2021	\$ 158.40	Square One Arch	Messner Filtration
12/20/2021	\$ 6,983.00	Art Wahl	Stern Residence
12/21/2021	\$ 158,222.80	Levon Ghukasyan	Village at the Park
3/23/2022	\$ 6,983.00	Crestview Ranch	Spanish Hills Estates
Total Received	\$ 172,347.20		
Interest Earned	\$ 11.90		

FY2023

Date Received	Amount	Applicant	Project
9/29/2022	\$ 218.40	Raymond Dickerhoff	Wedgewood Weddings
1/10/2023	\$ 7,712.79	Travis Rodriguez	Jenkins Residence
3/6/2023	\$ 7,712.79	Michael Dubin	600 Corte Corride
4/25/2023	\$ 187.98	Daiva McBride	House of Bamboo
4/28/2023	\$ 7,712.79	Phineas Turner	RPD-206
5/4/2023	\$ 69.81	Sustainability Engineering Group	Ralph's Fuel Center
5/24/2023	\$ 17,511.56	RJ Rieves	Rexford Ind.
5/26/2023	\$ 7,945.00	Siamak Rezvani	Crestview
Total Received	\$ 49,071.12		
Interest Earned	\$ 5,998.78		
PVRPD Administrative Fee	\$ (981.42)		

FY2024

Date Received	Amount	Applicant	Project
9/7/2023	\$ 1,771,314.00	Grant Williams	RPD-201 Camino Ruiz
11/30/2023	\$ 2,060.00	Dillon Merchant	Chick Fil-A
3/5/2024	\$ 660.00	Mahdi Rezvan	Arneill Pharmacy
3/18/2024	\$ 18,577.89	Robert Goetsch	IPD-405
3/26/2024	\$ 21,706.91	Charles Sandlin	Gleson/Dawson Self Storage

YTD Received	\$ 1,814,318.80
YTD Interest Earned	\$ 64,920.42
Balance as of 3/31/2024	\$ 2,105,686.80

5-Year Findings Report Due	FY2027 (w/in 180D)
	FY2032 (w/in 180D)
	FY2037 (w/in 180D)
	FY2042 (w/in 180D)

California CLASS

Investment Name	Oct-22	Nov-22	Dec-22	Jan-23	Feb-23	Mar-23	Apr-23	May-23	Jun-23
California CLASS	3.10%	3.80%	4.19%	4.53%	4.70%	4.77%	5.00%	5.15%	5.23%
	Jul-23	Aug-23	Sep-23	Oct-23	Nov-23	Dec-23	Jan-24	Feb-24	Mar-24
California CLASS	5.29%	5.45%	5.48%	5.51%	5.55%	5.54%	5.47%	5.44%	5.42%

- Rates are determined at the end of the month

Ventura County Pool

Investment Name	Oct-22	Nov-22	Dec-22	Jan-23	Feb-23	Mar-23	Apr-23	May-23	Jun-23
Ventura County Pool	1.92%	2.29%	2.74%	3.01%	3.15%	3.11%	3.60%	3.49%	3.56%
	Jul-23	Aug-23	Sep-23	Oct-23	Nov-23	Dec-23	Jan-24	Feb-24	Mar-24
Ventura County Pool	3.49%	3.51%	3.64%	3.78%	4.02%	4.26%	4.29%	4.39%	4.41%

Local Agency Investment Fund (LAIF)

Investment Name	Oct-22	Nov-22	Dec-22	Jan-23	Feb-23	Mar-23	Apr-23	May-23	Jun-23
Local Agency Investment Fund (LAIF)	1.77%	2.01%	2.17%	2.43%	2.62%	2.83%	2.87%	2.99%	3.17%
	Jul-23	Aug-23	Sep-23	Oct-23	Nov-23	Dec-23	Jan-24	Feb-24	Mar-24
Local Agency Investment Fund (LAIF)	3.31%	3.43%	3.53%	3.67%	3.84%	3.93%	4.01%	4.12%	4.23%

** To be released after packet was prepared*

Pacific Western Bank

Investment Name	Oct-22	Nov-22	Dec-22	Jan-23	Feb-23	Mar-23	Apr-23	May-23	Jun-23
Pacific Western Bank	0.04%	0.04%	0.04%	0.04%	0.04%	0.04%	0.04%	0.04%	0.04%
	Jul-23	Aug-23	Sep-23	Oct-23	Nov-23	Dec-23	Jan-24	Feb-24	Mar-24
Pacific Western Bank	0.04%	0.04%	0.04%	0.04%	0.04%	0.04%	0.04%	0.04%	0.04%

Bank Reconciliation

Board Audit

User: Cwebster
 Printed: 04/03/2024 - 2:59PM
 Date Range: 03/01/2024 - 03/31/2024
 Systems: 'AP'



Check No.	Vendor/Employee	Transaction Description	Date	Amount
Fund: 10 General Fund				
Department: 00 Non Departmentalized				
0	AFLAC	AFLAC: BILLING PERIOD FEB 202	03/04/2024	661.44
0	CALPERS HEALTH	CALPERS: HEALTH INSURANCE M	03/04/2024	43,386.26
0	CALPERS PENSION	CALPERS: PR CONT 3/14/2024 / RA	03/14/2024	17,350.36
0	CALPERS PENSION	CALPERS: PR CONT 3/28/2024 / PL	03/28/2024	17,319.57
0	EMPLOYMENT DEVELOPMENT DI	EDD: DE88 PMT PR 3/14/2024	03/14/2024	3,802.93
0	EMPLOYMENT DEVELOPMENT DI	EDD: DE 88 PMT / PR 3/28/2024	03/28/2024	3,688.70
0	GUARDIAN	GUARDIAN: DENTAL INS BILLING	03/04/2024	3,827.12
0	HARTFORD LIFE & ACC. INSURAN	HARTFORD: BILL PERIOD 2024-3/	03/04/2024	1,889.72
0	HUB INTERNATIONAL INSURANC	HUB: INSURANCE JAN 2024	03/07/2024	945.00
0	INTERNAL REVENUE SERVICE - O	IRS: EFTPS 941 PMT / PR 3/14/2024	03/14/2024	25,672.68
0	INTERNAL REVENUE SERVICE - O	IRS: EFPTS 941 PMT / PR 3/28/2024	03/28/2024	24,947.00
0	US BANK, NA	US BANK: INTEREST PMT / PV 201	03/19/2024	207,773.91
0	VSP	VSP: VISION BILLING MAR 2024	03/04/2024	646.35
26889	CAMARILLO COUNCIL OF PTAS	CAM COUNCIL PTA: CLEANING E	03/07/2024	300.00
26908	FRANCHISE TAX BOARD	FTB: EDWARD A. KAISER / ACCT#	03/14/2024	207.10
26909	METLIFE INSURANCE CO USA	METLIFE: JAVIER JUAREZ/SSN X	03/14/2024	100.00
26916	CAPRI	CAPRI: 4TH QTR WORK COMP FY	03/21/2024	59,146.00
26928	TAIWANESE ASSOC OF NORTHWE	TAIWANESE ASSOC OF NW LA: CI	03/21/2024	300.00
26932	UNIVERSITY PREP CHARTER SCH	UNIV PREP CHARTER SCHOOL: C	03/21/2024	300.00
26934	METLIFE INSURANCE CO USA	METLIFE: JUAREZ, JAVIER/ SSN 4	03/28/2024	100.00
Total for Department: 00 Non Departmentalized				412,364.14
Department: 03 Recreation				
0	AMAZON	AMAZON: SUPPLIES	03/07/2024	42.66
0	AMAZON	AMAZON: HOME PLATE EXTENSI	03/21/2024	48.09
0	BEGINNERS EDGE SPORTS TRAIN	BEGINNERS EDGE SPORTS: SOCC	03/21/2024	1,353.69
0	DEBRA GREENWOOD	GREENWOOD, D: WATER EXERCI	03/07/2024	1,006.85
0	DEBRA GREENWOOD	GREENWOOD, D: WATER EXERCI	03/21/2024	899.60
0	JANET SNYDER	SYNDER, J: DANCE TEN / FEB 202	03/07/2024	246.40
0	KATIE SHINDEN	SHINDEN, K: KINDERMUSIK CLA	03/07/2024	1,638.00
0	MACY TRUEBLOOD	TRUEBLOOD, M: MILEAGE REIMI	03/07/2024	28.21
0	MARK TUSLER	TUSLER, M: DRUM LESSONS / 101	03/21/2024	390.00
0	MUSCO SPORTS LIGHTING	MUSCO: LINK SVC FEES 2024-MA	03/07/2024	1,425.00
0	NANCE TAPLEY-PECK	TAPLEY-PECK FARM: HORSEBAC	03/07/2024	1,102.50
0	PATRICIA J. BOLLAND	BOLLAND, P: JAZZERCISE CLASS	03/07/2024	656.50
0	SOCAL GAS COMPANY	SCG: SVC DATE 2024-1/24 - 2/23 / A	03/04/2024	4,321.18
0	US BANK	US BANK: CAL CARD STMT 2/22/2	03/06/2024	2,194.23
26884	ALL GOOD DRIVING SCHOOL, INC	ALLGOOD DRIVING: ONLINE DRI	03/07/2024	30.10
26888	BINGO WEST #4	BINGO WEST: BINGO SUPPLIES	03/07/2024	60.57
26893	FUN EXPRESS	FUN EXPRESS: CANDY CRANE KI	03/07/2024	210.56
26894	DEBRA S HAGER	HAGER, D: LEGO CLASSES / 2024-	03/07/2024	1,872.00
26895	DANIEL E HOWARD	HOWARD, D: JU-JITSU CLASSES /	03/07/2024	468.00
26898	BRYAN MONKA	MONKA, B: SOCCER CLASSES / 20	03/07/2024	1,045.85
26904	UNITED STATES POSTAL SERVICE	USPS: BULK PERMIT#109 / ACTIV	03/07/2024	6,089.68
26906	DUNCAN YOUNG	YOUNG, D: GYMNASTIC CLASSE	03/07/2024	1,432.60
26914	DEBBIE LEE BAVARO	BAVARO, D: SEWING CLASS / 2 EN	03/21/2024	295.75
26921	ROBERT INGLIS	INGLIS, R: SCUBA CLASS / 1 ENR	03/21/2024	33.15
26933	AUDREY WALZER	WALZER, A: YOGA CLASS / 31 EN	03/21/2024	2,115.75

Check No.	Vendor/Employee	Transaction Description	Date	Amount
			Total for Department: 03 Recreation	29,006.92
Department: 04 Parks				
0	AMAZON	AMAZON: KEY RINGS	03/07/2024	440.86
0	ARAMSCO INC.	ARAMSCO: JANITORIAL SUPPLIE	03/07/2024	1,044.52
0	ARAMSCO INC.	ARAMSCO: EUREKA 12" ROLLER	03/21/2024	6,707.30
0	E.J.HARRISON AND SONS, INC.	EJ HARRISON: FEB 2024 BILLING	03/07/2024	4,459.31
0	FERGUSON ENTERPRISES INC. #1:	FERGUSON: PLUMBING / FREEDC	03/07/2024	424.94
0	HUB INTERNATIONAL INSURANC	HUB: INSURANCE JAN 2024	03/07/2024	-45.59
0	JESSE GOMEZ	GOMEZ, J: BOOTS REIMB	03/21/2024	157.33
0	LINCOLN AQUATICS	LINCOLN AQUATICS: CHLORINE ,	03/07/2024	876.87
0	LINCOLN AQUATICS	LINCOLN AQUATICS: CPO CERT C	03/21/2024	770.00
0	SITEONE LANDSCAPE SUPPLY LL	SITEONE: IRRIGATION SUPPLIES	03/21/2024	1,575.60
0	SOCAL GAS COMPANY	SCG: SVC DATE 2024-1/23 - 2/22 / C	03/04/2024	1,958.02
0	SOUTHERN CALIF EDISON COMP/	SCE: SVC DATE 2024-1/29 - 2/27 / S	03/06/2024	4,103.00
0	SOUTHERN CALIF EDISON COMP/	SCE: SVC DATE 2024-2/15 - 3/17 / T	03/19/2024	5,042.53
0	SPRINT/TMOBILE	TMOBILE: SVC DATE 2024-1/21 - 2	03/21/2024	268.50
0	UNITED SITE SERVICES OF CA INC	UNITED SITE: SVC DATE 2024-2/2:	03/07/2024	415.05
0	UNITED SITE SERVICES OF CA INC	UNITED SITE: SVC DATE 2024-3/1:	03/21/2024	188.17
0	US BANK	US BANK: CAL CARD STMT 2/22/2	03/06/2024	5,164.87
0	WATER & SANITATION SERVICES	W&S: SVC DATE 2024-1/31 - 2/29 /1	03/21/2024	577.18
0	WEX BANK	WEX: PURCHASE REBATE / FEB 2	03/21/2024	4,351.84
26886	B & B DO IT CENTER	B&B: BATTERIES FOR DRILL	03/07/2024	1,813.75
26887	BIGBRAND TIRE & SERVICE	BIGBRAND: SANDPRO REAR TIRI	03/07/2024	281.96
26890	CITY OF OXNARD-CITY TREASUR	CITY OF OXNARD: JAN 2024 REC'	03/07/2024	672.19
26891	COUNTY OF VENTURA	COUNTY OF VENTURA: REVENUE	03/07/2024	25.00
26896	KASTLE KARE	KASTLE KARE: GOPHER MONTHI	03/07/2024	600.00
26899	NAPA AUTO PARTS	NAPA: SANDPRO CART	03/07/2024	1,065.82
26907	CITY OF CAMARILLO	CITY OF CAMARILLO: SVC DATE	03/06/2024	6,012.56
26910	CITY OF CAMARILLO	CITY OF CAM: SVC DATE 2024-1/1	03/18/2024	3,199.86
26911	AGRX	AGRX: SPRAY SUITS / SHOP	03/21/2024	903.00
26912	AMERICAN RESOURCE RECVY	AMERICAN RESOURCE RECVY: F	03/21/2024	947.39
26913	B & B DO IT CENTER	B&B: SHOVEL/HOSE REPAIR/GLO	03/21/2024	627.75
26915	CAMROSA WATER DISTRICT	CAMROSA: SVC DATE 2024-1/31 -	03/21/2024	1,069.09
26918	CRESTVIEW MUTUAL WATER CO.	CRESTVIEW WATER CO: BILLING	03/21/2024	54.00
26919	DOG WASTE DEPOT	DOG WASTE DEPOST: DOG BAGS.	03/21/2024	4,266.41
26924	CARLA McALISTER	McALISTER, C: PARKING PASS RE	03/21/2024	96.00
26929	THE FINISH LINE	THE FINISH LINE: UNIFORM/ DAV	03/21/2024	250.82
26931	THOMPSON BUILDING MATERIAL	THOMPSON BLDG MATERIALS: C	03/21/2024	22.98
			Total for Department: 04 Parks	60,388.88
Department: 05 Administration				
0	ALESHIRE & WYNDER LLP	ALESHIRE & WYNDER: LEGAL SV	03/21/2024	2,241.00
0	AMAZON	AMAZON: HDMI CABLES	03/07/2024	8.82
0	AMAZON	AMAZON: OFFICE SUPPLIES	03/21/2024	168.16
0	AMILIA TECHNOLOGIES USA, INC	AMILIA: SMART REC FEB 2024 AC	03/07/2024	4,354.20
0	CALPERS HEALTH	CALPERS: HEALTH INSURANCE M	03/04/2024	150.87
0	CULLIGAN OF VENTURA COUNTY	CULLIGAN: SVC DATE 2024-3/1 - 3	03/07/2024	35.70
0	J. THAYER COMPANY	J THAYER: OFFICE SUPPLIES	03/21/2024	170.08
0	KONICA MINOLTA PREMIER FINA:	KONICA MINOLTA: BILLING PERI	03/21/2024	573.19
0	QUADIANT FINANCE USA INC.	QUADIANT: POSTAGE	03/07/2024	250.00
0	QUADIANT LEASING USA, INC.	QUADIANT LEASING: BILL PERIO	03/21/2024	261.41
0	SPECTRUM BUSINESS	SPECTRUM: BILL PERIOD 2024-2/1	03/07/2024	17.10
0	SPRINT/TMOBILE	TMOBILE: SVC DATE 2024-1/21 - 2	03/21/2024	47.80
0	US BANK	US BANK: CAL CARD STMT 2/22/2	03/06/2024	2,617.50
0	WATER & SANITATION SERVICES	W&S: PROCESSING FEE - SVC DA'	03/21/2024	0.75
26883	ADVANTAGE TELECOM/A+WIREL	ADVANTAGE TELECOM: INTERNI	03/07/2024	1,574.07
26885	ALLCONNECTED, INC.	ALLCONNECTED: MARCH 2024 B	03/07/2024	3,836.14
26901	SCI CONSULTING GROUP	SCI: ADMIN ASSESSMENT FY 202:	03/07/2024	6,775.00
26902	STATE OF CALIFORNIA DEPT. OF J	STATE OF CA: DEPT OF JUSTICE/1	03/07/2024	96.00
26903	DAVID TORFEH	TORFEH, D: HIKE 2/10/2024 MISSI	03/07/2024	50.00

Check No.	Vendor/Employee	Transaction Description	Date	Amount
26917	CENTERS FOR FAMILY HEALTH	CENTERS FAM HEALTH: SVC DAI	03/21/2024	160.00
26922	KONICA MINOLTA	KONICA MINOLTA: BIZ HUB 4020/	03/21/2024	114.90
26923	PAUL LERMA	LERMA, P: JR RANGER/ CAM GRC	03/21/2024	62.50
26926	STATE OF CALIFORNIA DEPT. OF J	STATE OF CA: DEPT OF JUSTICE/1	03/21/2024	64.00
26927	CODY SWANSON	SWANSON, C: HIKE 2/17/2024	03/21/2024	62.50
26930	THE HOME DEPOT PRO	HOME DEPOT: 5 SHELF UNIT /IT S	03/21/2024	162.39
Total for Department: 05 Administration				23,854.08
Total for Fund:10 General Fund				525,614.02

Check No.	Vendor/Employee	Transaction Description	Date	Amount
Fund: 20 Assessment Fund				
Department: 00 Non Departmentalized				
26892	EXECUTIVE FACILITIES SERVICES	EXECUTIVE FACILITES: JANITOR	03/07/2024	407.57
26900	NATURAL GREEN LANDSCAPES, I	NATURAL GREEN LANDSCAPE: F	03/07/2024	16,659.27
26905	WEST COAST ARBORISTS INC.	WCA: GRID PRUNING / FREEDOM	03/07/2024	10,744.50
26920	EXECUTIVE FACILITIES SERVICES	EXECUTIVE FACILITIES SVC: JAN	03/21/2024	6,151.68
26925	SHOWSCAPES, INC	SHOWSCAPES: TREE MAINTENAI	03/21/2024	25,059.33
Total for Department: 00 Non Departmentalized				59,022.35
Total for Fund:20 Assessment Fund				59,022.35

Check No.	Vendor/Employee	Transaction Description	Date	Amount
Fund: 30 Park Dedication Fund				
Department: 00				
0	AMAZON	AMAZON: HDMI CABLES	03/07/2024	207.11
0	B&H FOTO & ELECTRONICS CORP	B&H: WIRELESS HANDHELD MIC	03/07/2024	588.80
0	US BANK	US BANK: CAL CARD STMT 2/22/2	03/06/2024	3,639.69
26897	LAUTERBACH & ASSOCIATES, INC	LAUTERBACH: SVC JAN 2024/ PH.	03/07/2024	3,818.75
26910	CITY OF CAMARILLO	CITY OF CAM: SVC DATE 2024-1/3	03/18/2024	225.21
Total for Department: 00				8,479.56
Total for Fund:30 Park Dedication Fund				8,479.56

Check No.	Vendor/Employee	Transaction Description	Date	Amount
		Grand Total		593,115.93

**PLEASANT VALLEY RECREATION AND PARK DISTRICT
STAFF REPORT / AGENDA REPORT**

TO: BOARD OF DIRECTORS

FROM: MARY OTTEN, GENERAL MANAGER
By: Justin Kiraly, Administrative Services Manager

DATE: May 1, 2024

SUBJECT: FINANCE REPORT MARCH 2024

ANALYSIS OF COMPARATIVE FINANCIALS THROUGH MARCH 31, 2024

The District's Statements of Revenues and Expenditures for the period of March 1, 2024, through March 31, 2024, with a year-to-date comparison for the period of March 1, 2023, through March 28, 2023, are attached. The percentage rate used is 75% for Period 9 of the current fiscal year. All dollar amounts are rounded.

REVENUES

Total revenue including the 9th month ending March 31, 2024, for Fund 10 (General Fund) has an overall increase of \$1,166,820 in comparison to Fiscal Year 2022-2023. The variance from the prior year includes: 1) increase in total Tax Apportionment (5110-5120) of \$458,026.85, 2) increase in Rentals (5530) of \$233,493, 3) increase in Public Fees (5510-5520) received of \$116,396, and 4) increase in Interest Revenue (5310) received of \$218,448. The increase in Tax Apportionment is mostly due to higher home sales in 2022-2023. The increase in Rentals is due to increases in rental fees. Public fees have seen an increase due to continued interest from residents in District offered services, such as Camp Funtastic. Interest rates continue to stay higher than last year, leading to increased returns.

Total revenue recorded for Fund 20 for March 2024, the Assessment District Fund, was \$4,690, overall year-to-date increase of \$41,551 from year prior.

Total revenue recorded for Fund 30 for March 2024, the Quimby Fund, was \$18,335 in interest. Quimby funds are only collected when new housing developments are subdivided.

Total revenue recorded for Fund 40 for March 2024, the Park Impact Fees Fund, was \$9,447 in interest and \$40,945 in Park Impact development fees. Park Impact Fees are only collected when certain requirements are met for whenever additional square footage is added to either residential or commercial properties, following certain criteria.

Total revenue recorded for Fund 50 for March 2024, the Community Development Block Grant (CDBG) Food Share Fund, was \$8,170. Reimbursement requests are made on a quarterly basis.

Total revenue recorded for Fund 60 for March 2024, the Restricted Donations Fund, was \$0. Fund 60 was established to keep donations made for a specific purpose/project separate from all other funds. The only money that was kept in Fund 60 was for the Miracle League of the 805 Ballfield. This project has been completed and Fund 60 will be unused until future donations are received.

EXPENDITURES

Fund 10 Personnel Expenditures: Excluding the Unfunded Liability payment to CalPERS (6170) of \$494,762, there was an increase in salaries and benefits year-over-year of \$85,006. This is due primarily to cost of living and merit increases.

Fund 10 Service and Supply Expenditures show an increase of \$770,655 in comparison to the same period last year.

Excluding reserves, the increase in Services and Supplies year-to-date is \$752,858. This increase includes: Appropriation Redevelopment/Collection Fees (6960) being \$161,931 more than last year since these fees are a percentage of Tax Apportionment, Insurance Liability (6410) being \$87,810 more than last year, an increase in Utilities – Water (7820) of \$29,295 due to drier and warmer months through December and water rate increases effective January 1, and an increase in COP Debt – PV Fields (7950) of \$341,040 due to payment made in April of last year and increased costs of Pleasant Valley Fields maintenance requiring paying more of the COP Debt for Pleasant Valley Fields from the General Fund instead of Assessment, in order to free up funds in the Assessment Fund 20 budget.

Fund 10 Capital Expenditures shows an increase of \$47,713 in comparison to the same period last year.

Fund 10 Total Expenditures year-to-date are \$889,760 more compared to this point last year.

Fund 20 Expenditures are \$81,519 in Personnel and \$823,550 in Services and Supplies in total as of this month. Total expenditures are \$2,778 less than this time last year, due to the reallocation of COP Debt to be paid from the General Fund in order to free up funds for contracted services.

Fund 30 has Expenditures of \$4,044 for the Freedom Park Pickleball Sports Complex and \$4,436 for the Senior Center Improvements this month.

Fund 40 has Expenditures of \$981.42 paid to the District for Administrative fees from the FY 2022-2023 collection period for this month.

Fund 50 has Personnel Expenses of \$1,503 and Services and Supplies Expenses of \$0 for this month. The District received an additional allocation of funds for CDBG to purchase supplies for future use. These expenses will be reimbursed from the CDBG Food Share grant received from the City of Camarillo.

Fund 60 has no Expenditures this month.

FISCAL IMPACT

Overall, the financials show the District is under the approved budget for Fund 10 by 36.87%, Fund 20 by 29.97%, Fund 30 by 93.92%, and Fund 50 by 32.88%. Fund 60 is no longer being used. Fund 40 has no budget.

RECOMMENDATION

It is recommended the Board review and approve the Financial Statements for March 31, 2024, for Fund 10, Fund 20, Fund 30, Fund 40, and Fund 50.

ATTACHMENTS

- 1) Financial Statement of Revenues and Expenditures as of March 31, 2024, Fund 10
(2 pages)
- 2) Financial Statement of Revenues and Expenditures as of March 31, 2024, Fund 20
(1 page)
- 3) Financial Statement of Revenues and Expenditures as of March 31, 2024, Fund 30
(1 page)
- 4) Financial Statement of Revenues and Expenditures as of March 31, 2024, Fund 40
(1 page)
- 5) Financial Statement of Revenues and Expenditures as of March 31, 2024, Fund 50
(1 page)

General Ledger
Fund 10 General Fund
March 2024 75.0%

Description	Account	Period Amount	One Year Prior Actual	Year to Date	Budget	Budget Remaining	% of Budget Used
Revenue							
Tax Apportionment	5110-5240	\$ 18,328.21	\$ 4,338,737.35	\$ 4,796,764.20	\$ 8,109,714.00	\$ 3,312,949.80	59.15%
Interest Earnings	5310	\$ 37,165.29	\$ 128,433.68	\$ 346,881.34	\$ 300,000.00	\$ (46,881.34)	115.63%
Carryover Balance	5502	\$ -	\$ -	\$ -	\$ 15,000.00	\$ 15,000.00	0.00%
Park Patrol Citations	5506	\$ -	\$ 1,963.39	\$ 2,802.80	\$ 2,300.00	\$ (502.80)	121.86%
Bingo - Primary Revenue	5508	\$ 2,216.00	\$ 15,829.55	\$ 17,850.42	\$ 19,750.00	\$ 1,899.58	90.38%
Excess Bingo Revenue	5509	\$ -	\$ 9,536.00	\$ 3,212.00	\$ 1,800.00	\$ (1,412.00)	178.44%
Contract Classes-Public Fees	5510	\$ 18,017.57	\$ 145,629.29	\$ 190,064.05	\$ 183,357.00	\$ (6,707.05)	103.66%
Public Fees	5511	\$ 16,622.75	\$ 174,012.48	\$ 241,358.34	\$ 305,964.00	\$ 64,605.66	78.88%
Public Fees-Entry Fees	5520	\$ 5,224.00	\$ 34,172.00	\$ 38,787.50	\$ 41,600.00	\$ 2,812.50	93.24%
Vending Concessions	5525	\$ -	\$ 1,132.72	\$ -	\$ 1,450.00	\$ 1,450.00	0.00%
Rental	5530	\$ 48,493.18	\$ 302,010.76	\$ 535,503.70	\$ 550,793.00	\$ 15,289.30	97.22%
Cell Tower Revenue	5535	\$ 13,366.98	\$ 84,533.71	\$ 126,320.65	\$ 159,600.00	\$ 33,279.35	79.15%
Parking Fees	5540	\$ 1,632.88	\$ 11,708.41	\$ 23,758.62	\$ 17,350.00	\$ (6,408.62)	136.94%
Advertising Revenue	5555	\$ -	\$ 9,225.00	\$ 6,150.00	\$ 6,000.00	\$ (150.00)	102.50%
Sponsorships/Donations	5558	\$ -	\$ -	\$ 4,807.47	\$ 2,500.00	\$ (2,307.47)	192.30%
Special Event	5561	\$ -	\$ 56,205.55	\$ 22,303.19	\$ 125,120.00	\$ 102,816.81	17.83%
Staffing Cost Recovery - Parks	5563	\$ 4,282.75	\$ 25,780.25	\$ 39,102.50	\$ 41,212.00	\$ 2,109.50	94.88%
Special Event Permits	5564	\$ 200.00	\$ 950.00	\$ 2,190.00	\$ 1,100.00	\$ (1,090.00)	199.09%
Security Services - Recovery	5566	\$ 1,550.00	\$ 5,236.00	\$ 11,825.00	\$ 5,000.00	\$ (6,825.00)	236.50%
Contributions	5570	\$ 50.00	\$ -	\$ 493.82	\$ 716.50	\$ 222.68	68.92%
Other Misc Revenue	5575	\$ 4,816.42	\$ 34,398.96	\$ 62,158.94	\$ 35,250.00	\$ (26,908.94)	176.34%
Restricrted Donation	5576	\$ -	\$ -	\$ 5,098.00	\$ 5,098.00	\$ -	100.00%
Incentive Income	5585	\$ 17.94	\$ 2,261.14	\$ 1,289.33	\$ 1,700.00	\$ 410.67	75.84%
Reimbursement - ROPS	5600	\$ -	\$ 496,791.60	\$ 566,645.76	\$ 350,000.00	\$ (216,645.76)	161.90%
Revenue		\$ 171,983.97	\$ 5,878,547.84	\$ 7,045,367.63	\$ 10,282,374.50	\$ 3,237,006.87	68.52%
YTD Comparison				\$ 1,166,819.79			
Personnel							
Full Time Salaries	6100	\$ 201,805.16	\$ 1,910,988.70	\$ 1,953,805.77	\$ 2,804,745.00	\$ 850,939.23	69.66%
Overtime Salaries	6101	\$ 831.33	\$ 11,657.90	\$ 13,622.80	\$ 28,035.00	\$ 14,412.20	48.59%
Car Allowance	6105	\$ 825.52	\$ 8,307.40	\$ 7,842.44	\$ 7,600.00	\$ (242.44)	103.19%
Cell Phone Allowance	6108	\$ 1,283.00	\$ 11,401.40	\$ 10,508.07	\$ 15,960.00	\$ 5,451.93	65.84%
Part-Time Salaries	6110	\$ 29,917.58	\$ 304,185.26	\$ 339,128.35	\$ 628,173.00	\$ 289,044.65	53.99%
Retirement	6120	\$ 35,108.06	\$ 314,540.95	\$ 336,927.78	\$ 532,840.00	\$ 195,912.22	63.23%
457 Pension	6121	\$ 87.17	\$ 22,542.64	\$ 6,940.80	\$ 10,000.00	\$ 3,059.20	69.41%
Deferred Compensation	6125	\$ 399.46	\$ 3,698.18	\$ 3,794.87	\$ 5,193.00	\$ 1,398.13	73.08%
Employee Insurance	6130	\$ 32,149.67	\$ 239,784.91	\$ 248,181.62	\$ 432,616.00	\$ 184,434.38	57.37%
Workers Compensation	6140	\$ 12,748.85	\$ 124,710.52	\$ 117,203.11	\$ 186,770.00	\$ 69,566.89	62.75%
Unemployment Insurance	6150	\$ -	\$ 1,132.00	\$ -	\$ 10,000.00	\$ 10,000.00	0.00%
PERS Unfunded Liability	6170	\$ -	\$ 508,376.00	\$ 494,762.00	\$ 494,762.00	\$ -	100.00%
Personnel		\$ 315,155.80	\$ 3,461,325.86	\$ 3,532,717.61	\$ 5,156,694.00	\$ 1,623,976.39	68.51%
YTD Comparison				\$ 71,391.75			
Services and Supplies							
Telephone/Internet	6210	\$ 1,902.32	\$ 14,283.03	\$ 16,748.01	\$ 21,692.00	\$ 4,943.99	77.21%
IT Services	6220	\$ 3,836.14	\$ 40,798.72	\$ 44,907.41	\$ 64,298.00	\$ 19,390.59	69.84%
IT Hardware	6230	\$ 8.82	\$ 62.72	\$ 45.77	\$ 2,000.00	\$ 1,542.23	22.89%
Hardware/Software Services	6240	\$ 6,274.10	\$ 51,218.78	\$ 48,971.96	\$ 73,586.00	\$ 24,614.04	66.55%
Pool Chemicals	6310	\$ 893.66	\$ 3,347.93	\$ 3,887.25	\$ 7,250.00	\$ 3,362.75	53.62%
Janitorial Supplies	6320	\$ 8,193.68	\$ 31,903.48	\$ 46,638.08	\$ 49,800.00	\$ 3,161.92	93.65%
Kitchen Supplies	6330	\$ 10.73	\$ 74.84	\$ 132.09	\$ 700.00	\$ 567.91	18.87%
Food Supplies	6340	\$ 971.14	\$ 4,353.03	\$ 8,267.04	\$ 6,625.00	\$ (1,642.04)	124.79%
Water Maint & Service	6350	\$ 35.70	\$ 581.78	\$ 531.60	\$ 900.00	\$ 368.40	59.07%
Laundry/Wash Service	6360	\$ -	\$ -	\$ 268.50	\$ 1,120.00	\$ 851.50	23.97%
Medical Supplies	6380	\$ -	\$ -	\$ -	\$ 1,390.00	\$ 1,390.00	0.00%
Insurance Liability	6410	\$ -	\$ 289,778.00	\$ 377,588.00	\$ 377,588.00	\$ -	100.00%
Equipment Maintenance	6500	\$ -	\$ 24.54	\$ 1,629.02	\$ 1,600.00	\$ (1,604.62)	101.81%
Fuel	6510	\$ 4,578.79	\$ 45,018.71	\$ 45,347.48	\$ 68,475.00	\$ 23,127.52	66.22%
Vehicle Maintenance	6520	\$ 1,511.45	\$ 28,223.10	\$ 29,663.11	\$ 38,100.00	\$ 8,436.89	77.86%
Building Repair	6600	\$ 2,148.28	\$ 47,719.16	\$ 43,976.38	\$ 67,500.00	\$ 23,523.62	65.15%
HVAC Maintenance/Repairs	6620	\$ -	\$ 4,504.98	\$ 4,927.17	\$ 8,820.00	\$ 3,892.83	55.86%
Playground Maintenance	6630	\$ 149.44	\$ 4,147.47	\$ 23,304.69	\$ 35,000.00	\$ 11,695.31	66.58%
Grounds Maintenance	6710	\$ 6,731.06	\$ 56,890.89	\$ 63,263.99	\$ 101,220.00	\$ 39,531.61	62.50%
Tree Care	6719	\$ -	\$ 30,000.00	\$ 29,507.05	\$ 30,000.00	\$ 492.95	98.36%
Contracted LS Services	6720	\$ -	\$ -	\$ 198.40	\$ -	\$ (198.40)	-
Contracted Pest Control	6730	\$ -	\$ 3,000.00	\$ 2,400.00	\$ 4,020.00	\$ 1,620.00	59.70%
Rubbish & Refuse	6740	\$ 6,078.89	\$ 49,267.47	\$ 46,592.53	\$ 84,330.00	\$ 37,737.47	55.25%
Vandalism/Theft	6750	\$ -	\$ 350.12	\$ 1,147.53	\$ 1,000.00	\$ (147.53)	114.75%
Memberships	6810	\$ -	\$ 14,192.82	\$ 14,315.00	\$ 16,952.00	\$ 2,637.00	84.44%
Office Supplies	6910	\$ 390.59	\$ 4,517.46	\$ 14,925.06	\$ 33,950.00	\$ 19,024.94	43.96%
Postage Expense	6920	\$ 6,342.68	\$ 18,262.97	\$ 18,178.84	\$ 18,700.00	\$ 521.16	97.21%
Advertising Expense	6930	\$ -	\$ 367.38	\$ 565.00	\$ 3,040.00	\$ 2,475.00	18.59%
Printing Charges	6940	\$ 688.09	\$ 5,952.40	\$ 5,484.48	\$ 13,126.00	\$ 7,641.52	41.78%
Bank & Registration Fees	6950	\$ 103.90	\$ 1,806.88	\$ 659.78	\$ 3,920.00	\$ 3,260.22	16.83%

General Ledger
Fund 10 General Fund
March 2024 75.0%

Description	Account	Period Amount	One Year Prior Actual	Year to Date	Budget	Budget Remaining	% of Budget Used
Approp Redevel/Collection Fees	6960	\$ -	\$ 320,107.31	\$ 482,038.07	\$ 684,039.00	\$ 202,000.93	70.47%
Minor Furn Fixture & Equip	6980	\$ 423.80	\$ 1,045.64	\$ 6,088.36	\$ 25,237.00	\$ 19,148.64	24.12%
Fingerprint Fees (HR)	7010	\$ 280.00	\$ 1,233.00	\$ 958.00	\$ 3,360.00	\$ 2,402.00	28.51%
Fire & Safety Insp Fees	7020	\$ -	\$ 144.11	\$ 304.00	\$ 6,675.00	\$ 6,371.00	4.55%
Permit & Licensing Fees	7030	\$ 312.36	\$ 4,908.97	\$ 7,183.89	\$ 7,300.00	\$ 116.11	98.41%
Professional Services	7100	\$ -	\$ 23,515.00	\$ 32,947.13	\$ 270,200.00	\$ 237,252.87	12.19%
Legal Services	7110	\$ 2,241.00	\$ 42,261.35	\$ 43,309.75	\$ 90,000.00	\$ 46,690.25	48.12%
Typeset and Print Services	7115	\$ -	\$ 22,907.72	\$ 23,187.76	\$ 36,600.00	\$ 13,412.24	63.35%
Instructor Services	7120	\$ 14,761.74	\$ 92,363.72	\$ 106,389.38	\$ 108,902.00	\$ 2,512.62	97.69%
PERS Admin Fees	7125	\$ 150.87	\$ 1,057.67	\$ 1,296.33	\$ 2,200.00	\$ 903.67	58.92%
Audit Services	7130	\$ -	\$ 16,075.00	\$ 7,750.00	\$ 17,425.00	\$ 9,675.00	44.48%
Medical & Health Svcs	7140	\$ 160.00	\$ 3,693.44	\$ 2,320.00	\$ 10,720.00	\$ 8,400.00	21.64%
Security Services	7150	\$ -	\$ 2,205.00	\$ 5,589.69	\$ 7,122.00	\$ 1,532.31	78.48%
Entertainment Services	7160	\$ -	\$ 432.25	\$ 4,723.26	\$ 4,300.00	\$ (423.26)	109.84%
Business Services	7180	\$ 13,408.51	\$ 36,650.82	\$ 66,413.60	\$ 95,805.00	\$ 29,391.40	69.32%
Umpire/Referee Services	7190	\$ -	\$ 1,150.00	\$ 965.00	\$ 1,700.00	\$ 735.00	56.76%
Subscriptions	7210	\$ 11.98	\$ 199.92	\$ 1,207.54	\$ 2,375.00	\$ 1,167.46	50.84%
Rents & Leases - Equip	7310	\$ 603.22	\$ 5,568.66	\$ 11,374.66	\$ 48,720.00	\$ 37,345.34	23.35%
Bldg/Field Leases & Rental	7320	\$ -	\$ 60.00	\$ 60.00	\$ 60.00	\$ -	100.00%
Division Supplies	7410	\$ 248.04	\$ 4,390.35	\$ 14,706.28	\$ 30,365.00	\$ 15,658.72	48.43%
Program/Event Supplies	7420	\$ -	\$ 5,639.01	\$ -	\$ -	\$ -	-
Bingo Supplies	7430	\$ 60.57	\$ 2,818.16	\$ 2,304.54	\$ 4,800.00	\$ 2,495.46	48.01%
Sporting Goods	7440	\$ 1,246.93	\$ 3,328.78	\$ 5,173.85	\$ 8,400.00	\$ 3,226.15	61.59%
Arts and Craft Supplies	7450	\$ -	\$ -	\$ -	\$ 1,575.00	\$ 1,575.00	0.00%
Training Supplies	7460	\$ -	\$ 603.17	\$ 525.12	\$ 3,970.00	\$ 3,444.88	13.23%
Small Tools	7500	\$ 514.80	\$ 3,666.94	\$ 1,829.64	\$ 6,000.00	\$ 4,170.36	30.49%
Safety Supplies	7510	\$ -	\$ 1,252.20	\$ 1,256.03	\$ 4,415.00	\$ 3,158.97	28.45%
Uniform Allowance	7610	\$ 250.82	\$ 7,519.69	\$ 6,322.55	\$ 15,790.00	\$ 9,467.45	40.04%
Safety Clothing	7620	\$ 157.33	\$ 1,173.84	\$ 934.46	\$ 5,404.00	\$ 4,469.54	17.29%
Conference&Seminar Staff	7710	\$ 1,179.00	\$ 11,492.41	\$ 7,564.00	\$ 19,665.00	\$ 12,101.00	38.46%
Conference&Seminar Board	7715	\$ -	\$ 210.00	\$ 815.00	\$ 2,625.00	\$ 1,810.00	31.05%
Conference&Seminar Travel Exp	7720	\$ -	\$ 3,264.64	\$ 3,240.13	\$ 6,067.00	\$ 2,826.87	53.41%
Out of Town Travel Board	7725	\$ -	\$ 828.30	\$ 351.23	\$ 2,970.00	\$ 2,618.77	11.83%
Private Vehicle Mileage	7730	\$ 28.21	\$ 1,130.95	\$ 362.71	\$ 4,847.00	\$ 4,484.29	7.48%
Buses/Excursions	7750	\$ -	\$ 4,900.89	\$ 7,728.43	\$ 11,400.00	\$ 3,671.57	67.79%
Tuition/Book Reimbursement	7760	\$ -	\$ 100.00	\$ -	\$ 4,000.00	\$ 4,000.00	0.00%
Utilities - Gas	7810	\$ 6,279.20	\$ 50,443.98	\$ 30,989.73	\$ 49,133.00	\$ 18,143.27	63.07%
Utilities - Water	7820	\$ 10,912.69	\$ 433,533.41	\$ 472,828.30	\$ 786,277.00	\$ 313,448.70	60.14%
Utilities - Electric	7830	\$ 9,145.53	\$ 121,388.55	\$ 139,565.82	\$ 232,694.00	\$ 93,128.18	59.98%
Airport Assessment Exp	7840	\$ -	\$ -	\$ 1,265.00	\$ 14,000.00	\$ 12,735.00	9.04%
Awards and Certificates	7910	\$ -	\$ 8,257.15	\$ 6,983.30	\$ 18,190.00	\$ 11,206.70	38.39%
Meals for Staff Training	7920	\$ 97.50	\$ 854.91	\$ 798.45	\$ 3,500.00	\$ 2,701.55	22.81%
Employee Morale	7930	\$ -	\$ 2,210.91	\$ 2,920.58	\$ 5,500.00	\$ 2,579.42	53.10%
COP Debt - PV Fields	7950	\$ 207,773.91	\$ -	\$ 341,039.80	\$ 343,214.00	\$ 2,174.20	99.37%
Reserve Vehicle Fleet	7970	\$ -	\$ -	\$ 15,000.00	\$ 15,000.00	\$ 15,000.00	100.00%
Reserve Computer Fleet	7971	\$ -	\$ 5,000.00	\$ 8,000.00	\$ 8,000.00	\$ 8,000.00	100.00%
Reserve Dry Period	7973	\$ -	\$ 65,203.00	\$ 5,000.00	\$ 5,000.00	\$ 5,000.00	100.00%
Reserve Capital Improvements	7974	\$ -	\$ 20,000.00	\$ -	\$ -	\$ -	-
Reserve Repair/Oper/Admin	7975	\$ -	\$ 20,000.00	\$ 100,000.00	\$ 100,000.00	\$ 100,000.00	100.00%
Reserve - Compensated Absences	7976	\$ -	\$ 25,000.00	\$ 25,000.00	\$ 25,000.00	\$ 25,000.00	100.00%
Services and Supplies		\$ 321,097.47	\$ 2,130,439.48	\$ 2,901,094.59	\$ 4,297,243.00	\$ 1,549,148.41	67.51%
YTD Comparison				\$ 770,655.11			
Capital							
General Capital	8400	\$ -	\$ -	\$ 5,380.00	\$ 25,000.00	\$ 19,620.00	21.52%
Equip/Facility Replacement	8420	\$ -	\$ 87,391.42	\$ -	\$ 35,000.00	\$ 35,000.00	0.00%
Freedom Dog Park	8502	\$ -	\$ 1,047.34	\$ 3,868.74	\$ 3,740.74	\$ (128.00)	103.42%
Valle Lindo Court Resurface	8505	\$ -	\$ -	\$ 513.32	\$ 55,000.00	\$ 54,486.68	0.93%
Epoxy Pool Deck	8506	\$ -	\$ -	\$ 527.44	\$ 100,000.00	\$ 99,472.56	0.53%
Lokker Playground	8507	\$ -	\$ -	\$ 14,595.00	\$ 500,000.00	\$ 485,405.00	2.92%
PV Fields Irrigation Pumps	8508	\$ -	\$ -	\$ -	\$ 100,000.00	\$ 100,000.00	0.00%
PV Fields Sewer Lift Stations	8509	\$ -	\$ -	\$ 111,267.13	\$ 133,562.24	\$ 22,295.11	83.31%
Capital		\$ -	\$ 88,438.76	\$ 136,151.63	\$ 952,302.98	\$ 816,151.35	14.30%
YTD Comparison				\$ 47,712.87			
Expense		\$ 636,253.27	\$ 5,680,204.10	\$ 6,569,963.83	\$ 10,406,239.98	\$ 3,989,276.15	63.13%
YTD Comparison				\$ 889,759.73			
Revenue Total		\$ 171,983.97	\$ 5,878,547.84	\$ 7,045,367.63	\$ 10,282,374.50	\$ 3,237,006.87	68.52%
Expense Total		\$ 636,253.27	\$ 5,680,204.10	\$ 6,569,963.83	\$ 10,406,239.98	\$ 3,989,276.15	63.13%
YTD Revenue-Expenses			\$ 198,343.74	\$ 475,403.80			
YTD Comparison				\$ 277,060.06			

General Ledger
Fund 20 Assessment Fund
March 2024 75.0%

Description	Account	Period Amount	One Year Prior Actual	Year to Date	Budget	Budget Remaining	% of Budget Used
Revenue							
Tax Apportionment	5110	\$ -	\$ -	\$ -	\$ -	\$ -	0.00%
Interest Earnings	5310	\$ 4,666.62	\$ 14,997.02	\$ 36,640.07	\$ 20,000.00	\$ (16,640.07)	183.20%
Assessment Revenue	5500	\$ 23.86	\$ 722,093.12	\$ 742,000.81	\$ 1,293,871.00	\$ 551,870.19	57.35%
Revenue		\$ 4,690.48	\$ 737,090.14	\$ 778,640.88	\$ 1,313,871.00	\$ 535,230.12	59.26%
YTD Comparison				\$ 41,550.74			
Personnel							
Full Time Salaries	6100	\$ -	\$ 17,269.38	\$ 50,780.14	\$ 50,780.14	\$ -	100.00%
Cell Phone Allowance	6108	\$ -	\$ 138.60	\$ 132.93	\$ 132.93	\$ -	100.00%
Part-Time Salaries	6110	\$ -	\$ -	\$ 3,749.34	\$ 3,749.34	\$ -	100.00%
Retirement	6120	\$ -	\$ 2,833.78	\$ 9,932.61	\$ 9,932.61	\$ -	100.00%
Employee Insurance	6130	\$ -	\$ 3,513.67	\$ 10,870.97	\$ 10,870.97	\$ -	100.00%
Workers Compensation	6140	\$ -	\$ 1,938.35	\$ 6,053.26	\$ 6,053.26	\$ -	100.00%
Personnel		\$ -	\$ 25,693.78	\$ 81,519.25	\$ 81,519.25	\$ -	100.00%
YTD Comparison				\$ 55,825.47			
Services and Supplies							
Building Repair	6610	\$ -	\$ -	\$ 2,355.55	\$ 1,520.00	\$ (835.55)	154.97%
Incidental Costs - Assess	6709	\$ -	\$ 18,522.28	\$ 11,269.13	\$ 19,444.00	\$ 8,174.87	57.96%
Grounds Maintenance	6710	\$ -	\$ -	\$ 39,156.33	\$ 116,050.85	\$ 76,894.52	33.74%
Tree Care	6719	\$ 14,430.50	\$ 12,765.54	\$ 58,276.29	\$ 90,000.00	\$ 31,723.71	64.75%
Contracted LS Services	6720	\$ 44,591.85	\$ 317,109.94	\$ 299,127.37	\$ 535,641.00	\$ 236,513.63	55.84%
Park Amenities - Assess	6722	\$ -	\$ -	\$ -	\$ 34,000.00	\$ 34,000.00	0.00%
Rubbish & Refuse	6740	\$ -	\$ -	\$ 1,894.78	\$ 947.39	\$ (947.39)	200.00%
Bank & Registration Fees	6950	\$ -	\$ -	\$ -	\$ 70.00	\$ 70.00	0.00%
Approp Redev/Collection Fees	6960	\$ -	\$ -	\$ 1,844.30	\$ 3,500.00	\$ 1,655.70	52.69%
Rents & Leases - Equip	7310	\$ -	\$ -	\$ 846.65	\$ 846.65	\$ -	100.00%
COP Debt - PV Fields	7950	\$ -	\$ 533,756.09	\$ 408,779.69	\$ 408,780.00	\$ 0.31	100.00%
Services and Supplies		\$ 59,022.35	\$ 882,153.85	\$ 823,550.09	\$ 1,210,799.89	\$ 387,249.80	68.02%
YTD Comparison				\$ (58,603.76)			
Expense		\$ 59,022.35	\$ 907,847.63	\$ 905,069.34	\$ 1,292,319.14	\$ 387,249.80	70.03%
YTD Comparison				\$ (2,778.29)			
Revenue Total		\$ 4,690.48	\$ 737,090.14	\$ 778,640.88	\$ 1,313,871.00	\$ 535,230.12	59.26%
Expense Total		\$ 59,022.35	\$ 907,847.63	\$ 905,069.34	\$ 1,292,319.14	\$ 387,249.80	70.03%
YTD Revenue-Expenses			\$ (170,757.49)	\$ (126,428.46)			
YTD Comparison				\$ 44,329.03			

General Ledger
Fund 30 Quimby Fund
March 2024 75.0%

Description	Account	Period Amount	One Year Prior Actual	Year to Date	Budget	Budget Remaining	% of Budget Used
Revenue							
Interest Earnings	5310	\$ 18,334.64	\$ 51,015.78	\$ 257,697.53	\$ 120,000.00	\$ (137,697.53)	214.75%
Revenue		\$ 18,334.64	\$ 51,015.78	\$ 257,697.53	\$ 120,000.00	\$ (137,697.53)	214.75%
Capital							
General Capital	8400	\$ -	\$ -	\$ -	\$ 621,769.00	\$ 621,769.00	0.00%
Pickleball Sports Complex	8493	\$ 4,043.96	\$ 80,804.17	\$ 156,843.78	\$ 1,300,000.00	\$ 1,143,156.22	12.06%
Multi-Generation Center	8504	\$ -	\$ -	\$ -	\$ 1,000,000.00	\$ 1,000,000.00	0.00%
Senior Center Improvements	8510	\$ 4,435.60	\$ -	\$ 20,838.40	\$ -	\$ (20,838.40)	0.00%
Capital		\$ 8,479.56	\$ 80,804.17	\$ 177,682.18	\$ 2,921,769.00	\$ 2,744,086.82	6.08%
Expense		\$ 8,479.56	\$ 80,804.17	\$ 177,682.18	\$ 2,921,769.00	\$ 2,744,086.82	6.08%
Revenue Total		\$ 18,334.64	\$ 51,015.78	\$ 257,697.53	\$ 120,000.00	\$ (137,697.53)	214.75%
Expense Total		\$ 8,479.56	\$ 80,804.17	\$ 177,682.18	\$ 2,921,769.00	\$ 2,744,086.82	6.08%
YTD Revenue-Expenses		\$ -	\$ -	\$ -	\$ -	\$ -	0.00%
YTD Comparison				\$ -			

Date Received	Amount	Amount Earmarked	Developer	Development Case #	Amount Expended	Balance	Allocation Date
7/31/14	\$ 615,709.00	\$ 720,600.00	AMLI Residential	Springville (RPD-173)	\$ 615,709.00	\$ -	7/31/2019
1/31/15	\$ 2,250,489.70	\$ 2,250,489.70	Fairfield LLC		\$ 1,894,525.49	\$ 355,964.21	1/31/2020
8/8/16	\$ 2,649,209.00	\$ 3,200,000.00	Comstock/Elacora Mission Oaks		\$ 1,980,165.65	\$ 669,043.35	8/8/2021
8/10/16	\$ 474,353.00	\$ 629,500.00	KB Homes		\$ 230,159.82	\$ 244,193.18	8/10/2021
6/7/18	\$ 21,612.25	\$ 21,612.25	Crestview		\$ 20,838.17	\$ 774.08	6/7/2023
6/27/18	\$ -	\$ -	Aldersgate Construction		\$ 146,682.55	\$ -	REFUNDED
3/6/19	\$ 35,242.00	\$ 70,484.00	Habitat for Humanity	Barry St (RPD-203)	\$ -	\$ 35,242.00	9/17/2024
9/12/19	\$ -	\$ -	Aldersgate Construction		\$ 92,200.46	\$ -	REFUNDED
11/21/19	\$ 1,264,500.00	\$ 1,000,000.00	Shea Homes		\$ -	\$ 1,264,500.00	11/21/2024
7/29/22	\$ 2,840,447.45	\$ -	Williams Homes		\$ -	\$ 2,840,447.45	7/29/2027
8/5/22	\$ 347,625.00	\$ -	Somis Ranch Phase 1		\$ -	\$ 347,625.00	8/5/2027
10/20/22	\$ 278,100.00	\$ -	Somis Ranch Phase 2		\$ -	\$ 278,100.00	10/20/2027
3/15/23	\$ 313,508.00	\$ -	Barry 60 LP		\$ -	\$ 313,508.00	3/15/2028
	\$ 757,042.77	\$ -	Interest Account		\$ -	\$ 757,042.77	
Total	\$ 11,847,838.17	\$ 7,892,685.95			\$ 4,980,281.14	\$ 7,106,440.04	

General Ledger
Fund 40 Park Impact Fee Fund
March 2024 75.0%

Description	Account	Period Amount	One Year Prior Actual	Year to Date	Budget	Budget Remaining	% of Budget Used
Revenue							
Interest Earnings	5310	\$ 9,447.11	\$ 3,438.49	\$ 64,920.42	\$ 8,000.00	\$ (56,920.42)	811.51%
Park Impact Fees	5450	\$ 40,944.80	\$ 15,643.98	\$ 1,814,318.80	\$ -	\$ (1,814,318.80)	0.00%
Revenue		\$ 50,391.91	\$ 19,082.47	\$ 1,879,239.22	\$ 8,000.00	\$ (1,871,239.22)	23490.49%
Services and Supplies							
Administrative Fee	6951	\$ 981.42	\$ -	\$ 981.42	\$ -	\$ (981.42)	0.00%
Services and Supplies		\$ 981.42	\$ -	\$ 981.42	\$ -	\$ (981.42)	0.00%
Expense		\$ 981.42	\$ -	\$ 981.42	\$ -	\$ (981.42)	0.00%
Revenue Total		\$ 50,391.91	\$ 19,082.47	\$ 1,879,239.22	\$ 8,000.00	\$ (1,871,239.22)	23490.49%
Expense Total		\$ 981.42	\$ -	\$ 981.42	\$ -	\$ (981.42)	0.00%

General Ledger
Fund 50 CDBG Fund
March 2024 75.0%

Description	Account	Period Amount	One Year Prior Actual	Year to Date	Budget	Budget Remaining	% of Budget Used
Revenue							
CDBG - Food Share	5577	\$ 8,169.77	\$ 18,877.71	\$ 22,320.27	\$ 40,760.00	\$ 18,439.73	54.76%
Revenue		\$ 8,169.77	\$ 18,877.71	\$ 22,320.27	\$ 40,760.00	\$ 18,439.73	54.76%
Personnel							
Full Time Salaries	6100	\$ 1,279.04	\$ 3,269.43	\$ 5,912.99	\$ 17,413.00	\$ 11,500.01	33.96%
Part-Time Salaries	6110	\$ -	\$ 23,943.35	\$ 12,661.70	\$ 10,360.00	\$ (2,301.70)	122.22%
Retirement	6120	\$ 196.07	\$ 3,695.76	\$ 2,665.17	\$ 2,606.00	\$ (59.17)	102.27%
Employee Insurance	6130	\$ 12.78	\$ 14.91	\$ 269.33	\$ 336.00	\$ 66.67	80.16%
Workers Compensation	6140	\$ 15.22	\$ 432.93	\$ 226.78	\$ 489.00	\$ 262.22	46.38%
Personnel		\$ 1,503.11	\$ 31,356.38	\$ 21,735.97	\$ 31,204.00	\$ 9,468.03	69.66%
Services and Supplies							
Division Supplies	7410	\$ -	\$ -	\$ 5,624.03	\$ 9,556.00	\$ 3,931.97	58.85%
Services and Supplies		\$ -	\$ -	\$ 5,624.03	\$ 9,556.00	\$ 3,931.97	58.85%
Expense		\$ 1,503.11	\$ 31,356.38	\$ 27,360.00	\$ 40,760.00	\$ 13,400.00	67.12%
Revenue Total		\$ 8,169.77	\$ 18,877.71	\$ 22,320.27	\$ 40,760.00	\$ 18,439.73	54.76%
Expense Total		\$ 1,503.11	\$ 31,356.38	\$ 27,360.00	\$ 40,760.00	\$ 13,400.00	67.12%

**PLEASANT VALLEY RECREATION AND PARK DISTRICT
STAFF REPORT / AGENDA REPORT**

TO: BOARD OF DIRECTORS

FROM: MARY OTTEN, GENERAL MANAGER
By: Justin Kiraly, Administrative Services Manager

DATE: May 1, 2024

SUBJECT: CONSIDERATION AND ADOPTION OF RESOLUTION NO. 760, DECLARING INTENTION TO LEVY ASSESSMENTS FOR FY 2024-2025, PRELIMINARILY APPROVING THE ENGINEER'S REPORT, AND AUTHORIZING THE ISSUANCE OF A NOTICE FOR THE PUBLIC HEARING FOR THE PROPOSED FY 2024-2025 ASSESSMENTS FOR THE PARK MAINTENANCE AND RECREATION IMPROVEMENT DISTRICT FOR THE PLEASANT VALLEY RECREATION AND PARK DISTRICT

BACKGROUND

Every fiscal year Staff prepares an agenda report and resolution requesting the Board to adopt a resolution to declare the intention to levy an assessment for the fiscal year and for preliminary approval of the engineer's report created by SCI Consulting Group. In addition to the assessment, the report provides notice of a public hearing for the Park Maintenance and Recreation Improvement District for the Pleasant Valley Recreation and Park District.

On April 4, 2001, by Resolution No. 356, after receiving a weighted majority of 58.7% of ballots in support of the proposed assessment, the Board of Directors ordered the formation of and levied the first assessment within the Pleasant Valley Recreation and Park District which is now known as the Park Maintenance and Recreation Improvement Assessment District.

On February 7, 2024, the Board adopted Resolution No. 757, directing the preparation of an Engineer's Report for the District, and initiating the procedures for the continuation of the Assessment District for FY 2024-2025. The next step in levying assessments for the upcoming fiscal year is the adoption of a Resolution of Intent to Levy the Assessments for FY 2024-2025 and setting the place and time for a Public Hearing to consider the assessments.

ANALYSIS

To continue to levy the assessments, the Board directed SCI Consulting Group on February 7, 2024, to prepare an Engineer's Report for FY 2024-2025. This Engineer's Report, which includes the proposed budget for the assessments for FY 2024-2025 and the updated proposed assessments for each parcel in the District, was completed, but will not be filed with the District's legal counsel this year as the report only needs to be filed when there are significant changes, and there are no significant changes for this report.

The Board has the authority to approve an annual adjustment to the assessment rate by an amount equal to the change in the Los Angeles Consumer Price Index (CPI), not to exceed 3%. The Engineer's Report contains a proposed assessment rate adjustment of 3.0% for FY 2024-2025. The proposed 3.0% increase was attained through the CPI as of Dec 31, 2023, which was at 3.47%. The additional 0.47% will be "banked" and can be used at a later time when the CPI is below 3%. The Unused CPI Bank is a bank made up of any CPI throughout past years that exceed 3.0%. The current Unused CPI Balance is 5.95%. The increase will result in a \$47.56 per single-family equivalent benefit unit assessment.

Pending Board approval, a public hearing for the continuation of the assessments will be scheduled for June 5, 2024, at the hour of 6:00 p.m. Notification of the hearing will be given by publishing a notice, at least ten (10) days prior to the date of the hearing specified, in a newspaper circulated within the District. After the public hearing, the Board can, by resolution, levy the assessments for FY 2024-2025.

FISCAL IMPACT

There is no fiscal impact associated with this action.

Preliminary approval of the Engineer's Report and establishment of the hearing date allows for the development of the proposed budget and assessment rate. This information can then be released to District residents for comment at the June 5, 2024, hearing date.

RECOMMENDATION

It is recommended the Board adopt Resolution No 760, accepting the Engineer's Report including the proposed assessment rate and schedule the public hearing for June 5, 2024.

ATTACHMENT

- 1) Resolution No. 760 (3 pages)
- 2) Preliminary Engineer's Report for FY 2024-2025 (43 pages)
- 3) Assessment Rate Tracking and Summary (1 page)

RESOLUTION NO. 760

**A RESOLUTION DECLARING INTENTION TO CONTINUE
LEVYING ASSESSMENTS FOR FISCAL YEAR 2024-25,
PRELIMINARILY APPROVING THE ENGINEER'S REPORT,
AND AUTHORIZING THE ISSUANCE OF A NOTICE FOR THE PUBLIC HEARING
FOR THE PROPOSED FY 2024-25 ASSESSMENTS FOR THE
PARK MAINTENANCE AND RECREATION IMPROVEMENT DISTRICT
FOR THE PLEASANT VALLEY RECREATION AND PARK DISTRICT**

WHEREAS, on April 4th, 2001, by its Resolution No. 356, after receiving a weighted majority of 58.7% of ballots in support of the proposed assessment, which included an annual adjustment as described below under Section 5 hereof (the "Authorized Assessment"), the Board of Directors of the Pleasant Valley Recreation and Park District (the "Board") ordered the formation of and levied the first assessment within the Pleasant Valley Recreation and Park District, Park Maintenance and Recreation Improvement Assessment District (the "District") pursuant to the provisions of Article XIID of the California Constitution, and the Landscaping and Lighting Act of 1972 (the "Act"), Part 2 of Division 15 of the California Streets and Highways Code (commencing with Section 22500 thereof); and

WHEREAS, by Resolution No. 757, the Board ordered the preparation of an Engineer's Report for the District for fiscal year 2024-25; and

WHEREAS, pursuant to said Resolution, the Engineer's Report was prepared by SCI Consulting Group, Engineer of Work, in accordance with 22623, *et. seq.*, of the Streets and Highways Code (the "Report") and Article XIID of the California Constitution; and

WHEREAS, said Engineer's Report was filed with the Clerk of the Board of Directors and the Board of Directors has reviewed the Report and wishes to take certain actions relative to said Report.

NOW, THEREFORE, THE BOARD OF DIRECTORS OF THE PLEASANT VALLEY RECREATION AND PARK DISTRICT, CALIFORNIA, DOES RESOLVE AS FOLLOWS:

SECTION 1. The Report for the "PARK MAINTENANCE AND RECREATION IMPROVEMENT ASSESSMENT DISTRICT", on file with the Clerk of the Board, has been duly considered by the Board of Directors and is hereby deemed sufficient and approved. The Report shall stand as the Engineer's Report for all subsequent proceedings under, and pursuant to, the foregoing resolution.

SECTION 2. It is the intention of this Board to continue to levy and collect assessments within the Assessment District for fiscal year 2024-25. Within the District, the work and improvements (the "Improvements") proposed to be undertaken by the District, are generally described as installation, maintenance and servicing of public facilities, including but not limited to, playing fields, playground equipment, hard court surfaces, irrigation and sprinkler systems, landscaping, turf and track facilities, gymnasiums, swimming pools, landscaping, sprinkler

systems, park grounds, park facilities, landscape corridors, and trails, as applicable, for property owned or maintained by the Pleasant Valley Recreation and Park District. Maintenance means the furnishing of services and materials for the ordinary and usual maintenance, operation and servicing of said improvements, including repair, removal, or replacement of all or part of any improvement; providing for the life, growth, health and beauty of landscaping; and cleaning, sandblasting and painting of walls and other improvements to remove or cover graffiti. Servicing means the furnishing of electric current or energy for the operation or lighting of any improvements, and water for irrigation of any landscaping or the maintenance of any other Improvement.

SECTION 3. The District consists of the lots and parcels shown on the boundary map of the District on file with the Clerk of the Board, and reference is hereby made to such map for further particulars.

SECTION 4. Reference is hereby made to the Engineer's Report for a full and detailed description of the Improvements, the boundaries of the District and the proposed assessments upon assessable lots and parcels of land within the District. The Engineer's Report identifies all parcels which will have a special benefit conferred upon them and upon which an assessment will be imposed.

SECTION 5. The Authorized Assessment is subject to an annual adjustment tied to the Consumer Price Index-U for the Los Angeles Area, as published by United States Department of Labor, Bureau of Labor Statistics, as of December of each succeeding year (the "CPI"), with a maximum annual adjustment not to exceed 3%. Any change in the CPI in excess of 3% shall be cumulatively reserved as the "Unused CPI" and shall be used to increase the maximum authorized assessment rate in years in which the CPI is less than 3%. The maximum authorized assessment rate is equal to the maximum assessment rate in the first fiscal year the assessment was levied adjusted annually by the minimum of 1) 3% or 2) the change in the CPI plus any Unused CPI as described above.

The change in the CPI from December 2022 to December 2023 was 3.47%. Therefore, the maximum authorized assessment rate for fiscal year 2024-25 is increased by 3.00% which equates to \$47.56 per single family equivalent benefit unit. Single family equivalent values for different property types, such as commercial and industrial land uses are described in the Engineer's Report. The estimate of cost and budget in the Engineer's Report proposes assessments for fiscal year 2024-25 at the rate of \$47.56.

SECTION 6. Notice is hereby given that on June 5, 2024, at the hour of 6:00 o'clock p.m. at the Pleasant Valley Senior Center, 1605 E. Burnley Street, Camarillo, California the Board of Directors will hold a public hearing to consider the ordering of the Improvements and the continuation of the proposed assessments.

SECTION 7. Prior to the conclusion of the hearing, any interested person may file a written protest with the Clerk of the Board, or, having previously filed a protest, may file a written withdrawal of that protest. A written protest shall state all grounds of objection. A protest by a property owner shall contain a description sufficient to identify the property owned by such

owner. Such protest or withdrawal of protest should be mailed to Pleasant Valley Recreation and Park District, 1605 East Burnley Street, Camarillo, CA 93010.

SECTION 8. The Clerk of the Board shall cause a notice of the hearing to be given by publishing a copy of this resolution once, at least ten (10) days prior to the date of the hearing above specified, in a newspaper circulated in the Pleasant Valley Recreation and Park District.

PASSED AND ADOPTED this 1st day of May, 2024, by the following vote:

AYES:

NOES:

ABSENT:

ABSTAIN:

MARK MALLOY, CHAIRMAN
PLEASANT VALLEY RECREATION AND PARK DISTRICT

ATTESTED:

JORDAN ROBERTS, SECRETARY
PLEASANT VALLEY RECREATION AND PARK DISTRICT



ENGINEER'S REPORT

Pleasant Valley Recreation and Park District Park Maintenance and Recreation Improvement District

Fiscal Year 2024-25
April 2024

Pursuant to the Landscaping and Lighting Act of 1972
and Article XIID of the California Constitution

Engineer of Work:



SCI Consulting Group
Public Finance Consulting Services

4745 Mangels Boulevard
Fairfield, California 94534
707.430.4300
www.sci-cg.com
30/220

(This page intentionally left blank)

Table of Contents

Introduction 5

 Overview..... 5

 Assessment Process 6

 Engineer’s Report and Continuation of Assessments 7

 Legislative Analysis 8

Plans & Specifications 11

Fiscal Year 2024-25 Estimate of Cost and Budget..... 13

 Introduction..... 13

 Summary of District's Improvement Plans..... 13

Method of Apportionment..... 16

 Method of Apportionment..... 16

 Discussion of Benefit 16

 Benefit Factors 17

 Benefit Finding 20

 General versus Special Benefit 20

 Calculating General Benefit..... 22

 Zones of Benefit 25

 Method of Assessment and Proportionality 27

 Method of Apportionment..... 31

 Commercial/Industrial Properties..... 32

 Vacant Properties 33

 Other Properties..... 34

 Duration of Assessment 34

 Appeals and Interpretation 35

Assessment 36

Assessment Diagram 39

Appendix A - 2024-25 Assessment Roll..... 42

Table of Figures

Table 1 - Estimate of Cost, FY 2024-25	14
Table 2 - Summary of Parcels and Assessments by Zone of Benefit	26
Table 3 - Residential Density and Assessment Factors	31
Table 4 - Commercial/Industrial Density and Assessment Factors.....	33
Table 5 - Summary Cost Estimate	36

(This page intentionally left blank)

Introduction

Overview

The Pleasant Valley Recreation and Park District (the “Park District”) currently provides park facilities and recreational programs for its service area of 26,800 parcels. The Park District currently owns, operates and maintains 28 neighborhood, community, and regional parks which are distributed throughout the Park District. (For locations of the Park District’s facilities, see the Diagram following in this Report.)

The Park District’s facilities are summarized as follows:

District Parks

- ❖ **Adolfo Park**, (3.0 acres), 3601 N. Adolfo.
- ❖ **Arneill Ranch Park**, (5.0 acres), 1301 Sweetwater.
- ❖ **Birchview Park**, (0.7 acres), 5564 Laurel Ridge Lane, Birchview/Laurel Ridge.
- ❖ **Calleguas Creek Park**, (3.0 acres), 675 Avenida Valencia.
- ❖ **Camarillo Oak Grove Park**, (24.55 acres), 6968 Camarillo Springs Road.
- ❖ **Carmenita Park**, (1.0 acres), 1506 Sevilla.
- ❖ **Charter Oak Park**, (5.7 acres), 2500 Charter Oak Drive.
- ❖ **Community Center Park**, (12.9 acres), 1605 E. Burnley Street, Carmen/Burnley.
- ❖ **Dos Caminos Park**, (4.4 acres), 2198 N. Ponderosa Road, Las Posas/Ponderosa.
- ❖ **Encanto Park**, (3.0 acres), 5300 Encanto.
- ❖ **Foothill Park**, (2.3 acres), 1501 Cranbrook Street.
- ❖ **Freedom Park**, (33.9 acres), 275 E. Pleasant Valley Road, Skyway/Eubanks.
- ❖ **Heritage Park**, (9.0 acres), 1630 Heritage Trail, Joshua Trail/Heritage Trail.
- ❖ **Las Posas Equestrian Park**, (2.0 acres), 2084 Via Veneto, El Tuaca/Via Veneto.
- ❖ **Laurelwood Park**, (1.5 acres), 2127 Dexter, Mobil/Dexter.
- ❖ **Lokker Park**, (7.0 acres), 848 Vista Coto Verde, Calle Higuera/Avenida Sultura.
- ❖ **Mel Vincent Park**, (5.0 acres), 668 CALISTOGA ROAD.

- ❖ **Mission Oaks Park**, (20.2 acres), 5501 Mission Oaks Boulevard, Mission Oaks/Oak Canyon.
- ❖ **Nancy Bush Park**, (3.4 acres), 1150 Bradford.
- ❖ **Pitts Ranch Park**, (10.0 acres), 1400 Flynn Road.
- ❖ **Bob Kildee Community Park**, (13.0 acres), 1030 Temple Avenue, Ponderosa/Temple.
- ❖ **Quito Park**, (5.0 acres), 7073 Quito Court, Calle Dia/Quito.
- ❖ **Springville Park**, (5.0 acres), 801 Via Zamora.
- ❖ **Trailside Park**, (0.5 acres), 5462 Cherry Ridge Drive, Willow View/Maple View.
- ❖ **Valle Lindo Park**, (10.0 acres), 889 Aileen Street, Valle Lindo/Aileen.
- ❖ **Pleasant Valley Fields**, (55.0 acres), 3777 Village at the Park Drive.
- ❖ **Woodcreek Park**, (5.0 acres), 1200 Woodcreek Road, Lynwood/Woodcreek.
- ❖ **Woodside Park**, (5.0 acres), 247 Japonica Avenue, Ridgeview/Japonica.

Assessment Process

In 2001, due to the combination of limited revenues, a growing community and expanding park acreage, the Park District projected that it would not be able to adequately maintain its current and future parks and recreation facilities. Therefore, the Board proposed the establishment of an assessment district to provide adequate revenues for park maintenance services as well as for expanding and improving park facilities to meet the growing demand placed on the parks.

In February and March 2001, the Board conducted an assessment ballot proceeding pursuant to the requirements of Article XIID of the California Constitution (“The Taxpayer’s Right to Vote on Taxes Act”) and the Landscaping and Lighting Act of 1972. During this ballot proceeding, property owners in the District were provided with a notice and ballot for the proposed parks assessment (“the Parks Maintenance and Recreation Improvement District” or the “Improvement District”). A 45-day period was provided for balloting and a public hearing was conducted on March 21st, 2001. At the public hearing, all ballots returned within the 45-day balloting period were tabulated. It was determined at the public hearing that the assessment ballots submitted in opposition to the proposed assessments did not exceed the assessment ballots submitted in favor of the assessments (with each ballot weighted by the proportional financial obligation of the property for which ballot was submitted). The final balloting result was 58.7% weighted support in favor of the benefit assessments for the Pleasant Valley Recreation and Park District’s Park Maintenance and Recreation Improvement District.

As a result, the Board gained the authority to approve the levy of the assessments for the fiscal year 2001-02 and to continue to levy them in future years. The authority granted by the ballot proceeding includes an annual adjustment in the assessment levies equal to the annual change in the Consumer Price Index for the Los Angeles Area, not to exceed 3%.

Engineer’s Report and Continuation of Assessments

In each subsequent year for which the assessments will be continued, the Board must direct the preparation of an Engineer’s Report, budgets and proposed assessments for the upcoming fiscal year. After the Engineer’s Report is completed, the Board may preliminarily approve the Engineer’s Report and proposed assessments and establish the date for a public hearing on the continuation of the assessments. This Report was prepared pursuant to the direction of the Board adopted on February 7, 2024.

This Engineer’s Report (“Report”) was prepared to establish the budget for the continued improvements and services (“Improvements”) that would be funded by the proposed 2024-25 assessments, determine the benefits received by property from the improvements and services within the Park District and the method of assessment apportionment to lots and parcels within the Park District. This Report and the proposed assessments have been made pursuant to the Landscaping and Lighting Act of 1972, Part 2 of Division 15 of the *California Streets and Highways Code* (the “Act”) and Article XIID of the California Constitution (the “Article”).

If the Board preliminarily approves this Engineer’s Report and the continuation of the assessments by resolution. A notice of public hearing must be published in a local paper at least 10 days prior to the date of the public hearing. The resolution preliminarily approving the Engineer’s Report and establishing the date for a public hearing is used for this notice.

Following the minimum 10-day time period after publishing the notice, a public hearing is held for the purpose of allowing public testimony about the proposed continuation of the assessments. This hearing is currently scheduled for June 5, 2024. At this hearing, the Board would consider approval of a resolution confirming the continuation of the assessments for fiscal year 2024-25. If the assessments are so confirmed and approved, the levies would be submitted to the County Auditor/Controller by August 2024 for inclusion on the property tax roll for fiscal year 2024-25.

Legislative Analysis

Proposition 218

This assessment is formed consistent with Proposition 218, The Right to Vote on Taxes Act, which was approved by the voters of California on November 6, 1996, and is now codified as Articles XIIC and XIID of the California Constitution. Proposition 218 provides for benefit assessments to be levied to fund the cost of providing services, improvements, as well as maintenance and operation expenses to a public improvement which benefits the assessed property.

Proposition 218 describes a number of important requirements, including property-owner balloting, for the imposition, increase and extension of assessments, and these requirements are satisfied by the process used to establish this assessment.

Silicon Valley Taxpayers Association, Inc. v Santa Clara County Open Space Authority

In July of 2008, the California Supreme Court issued its ruling on the Silicon Valley Taxpayers Association, Inc. v. Santa Clara County Open Space Authority (“SVTA vs. SCCOSA”). This ruling is the most significant legal document in further legally clarifying Proposition 218. Several of the most important elements of the ruling included further emphasis that:

- Benefit assessments are for special, not general, benefit
- The services and/or improvements funded by assessments must be clearly specified and identified

- Special benefits are directly received by and provide a direct advantage to property in the assessment district
- The assessments must be proportional to the special benefits conferred

This Engineer's Report is consistent with the SVTA vs. SCCOSA decision and with the requirements of Article 13C and 13D of the California Constitution because the improvements to be funded are clearly defined; the benefiting properties in the Improvement District enjoys close and unique proximity, access and views to the Improvements; the Improvements serve as an extension of usable land area for benefiting properties in the Improvement District and such special benefits provide a direct advantage to property in the Improvement District that is not enjoyed by the public at large or other property; and the assessments are proportional to the special benefits conferred.

Dahms v. Downtown Pomona Property

On June 8, 2009, the 4th Court of Appeal amended its original opinion upholding a benefit assessment for property in the downtown area of the City of Pomona. On July 22, 2009, the California Supreme Court denied review. On this date, Dahms became good law and binding precedent for assessments. In Dahms the Court upheld an assessment that was 100% special benefit (i.e. 0% general benefit) on the rationale that the services and improvements funded by the assessments were directly provided to property in the assessment district. The Court also upheld discounts and exemptions from the assessment for certain properties.

Bonander v. Town of Tiburon

On December 31, 2009, the 1st District Court of Appeal overturned a benefit assessment approved by property owners to pay for placing overhead utility lines underground in an area of the Town of Tiburon. The Court invalidated the assessments on the grounds that the assessments had been apportioned to assessed property based in part on relative costs within sub-areas of the assessment district instead of proportional special benefits.

Beutz v. County of Riverside

On May 26, 2010 the 4th District Court of Appeal issued a decision on the Steven Beutz v. County of Riverside ("Beutz") appeal. This decision overturned an assessment for park maintenance in Wildomar, California, primarily because the general benefits associated with improvements and services were not explicitly calculated, quantified and separated from the special benefits.

Golden Hill Neighborhood Association v. City of San Diego

On September 22, 2011, the San Diego Court of Appeal issued a decision on the Golden Hill Neighborhood Association v. City of San Diego appeal. This decision overturned an assessment for street and landscaping maintenance in the Greater Golden Hill neighborhood of San Diego, California. The court described two primary reasons for its decision. First, like in *Beutz*, the court found the general benefits associated with services were not explicitly calculated, quantified and separated from the special benefits. Second, the court found that the City had failed to record the basis for the assessment on its own parcels.

Compliance with Current Law

This Engineer's Report is consistent with the requirements of Article XIIC and XIID of the California Constitution and with the *SVTA* decision because the improvements to be funded are clearly defined; the improvements are directly available to and will directly benefit property in the Improvement District; and the improvements provide a direct advantage to property in the Improvement District that would not be received in absence of the assessments.

This Engineer's Report is consistent with *Beutz*, *Dahms* and *Greater Golden Hill* because the improvements will directly benefit property in the Improvement District and the general benefits have been explicitly calculated and quantified and excluded from the assessments. The Engineer's Report is consistent with *Bonander* because the assessments have been apportioned based on the overall cost of the improvements and proportional special benefit to each property.

Plans & Specifications

The Pleasant Valley Recreation and Park District maintains park facilities in locations throughout its boundaries.

The work and improvements (the “Improvements”) proposed to be undertaken by the Pleasant Valley Recreation and Park District’s Park Maintenance and Recreation Improvement District (the “Improvement District”) and the cost thereof paid from the levy of the annual assessment provide special benefit to Assessor Parcels within the Improvement District as defined in the Method of Assessment herein. In addition to the definitions provided by the Landscaping and Lighting Act of 1972, (the “Act”) the work and improvements are generally described as follows:

Installation, maintenance and servicing of public recreational facilities and improvements, including, but not limited to, turf and play areas, playground equipment, hard court surfaces, ground cover, shrubs and trees, irrigation and sprinkler systems, landscaping, park grounds and facilities, drainage systems, lighting, fencing, entry monuments, basketball courts, tennis courts, gymnasiums, senior centers, running tracks, swimming pools, landscape corridors, trails, other recreational facilities, security patrols to protect the Improvements, graffiti removal and repainting, and labor, materials, supplies, utilities and equipment, as applicable, at each of the locations owned, operated or maintained by the Pleasant Valley Recreation and Park District. Any plans and specifications for these improvements have been filed with the General Manager of the Pleasant Valley Recreation and Park District and are incorporated herein by reference.

As applied herein, “Installation” means the construction of recreational improvements, including, but not limited to, land preparation (such as grading, leveling, cutting and filling) sod, landscaping, irrigation systems, sidewalks and drainage, lights, playground equipment, play courts, recreational facilities and public restrooms.

“Maintenance” means the furnishing of services and materials for the ordinary and usual maintenance, operation and servicing of any improvement, including repair, removal or replacement of all or any part of any improvement; providing for the life, growth, health, and beauty of landscaping, including cultivation, irrigation, trimming, spraying, fertilizing, or treating for disease or injury; the removal of trimmings, rubbish, debris, and other solid waste, and the cleaning, sandblasting, and painting of walls and other improvements to remove or cover graffiti.

“Servicing” means the furnishing of electric current, or energy, gas or other illuminating agent for any public lighting facilities or for the lighting or operation of any other improvements; or water for the irrigation of any landscaping, the operation of any fountains, or the maintenance of any other improvements.

Incidental expenses include all of the following: (a) The costs of preparation of the report, including plans, specifications, estimates, diagram, and assessment; (b) the costs of printing, advertising, and the giving of published, posted, and mailed notices; (c) compensation payable to the County for collection of assessments; (d) compensation of any engineer or attorney employed to render services in proceedings pursuant to this part; (e) any other expenses incidental to the construction, installation, or maintenance and servicing of the Improvements; (f) any expenses incidental to the issuance of bonds or notes pursuant to Streets & Highways Code Section 22662.5; and (g) costs associated with any elections held for the approval of a new or increased assessment. (Streets & Highways Code §22526).

The assessment proceeds will be exclusively used for Improvements within the Improvement District plus Incidental expenses. Reference is made to the Summary of District’s Improvement Plans section in the following section of this Report and the more detailed budgets and improvement plans of the Park District, which are on file with the Pleasant Valley Recreation and Park District.

Fiscal Year 2024-25 Estimate of Cost and Budget

Introduction

Following are the proposed Improvements, and resulting level of improved parks and recreation facilities, for the Improvement District. As previously noted, the baseline level of service included a declining level of parks and recreation facilities due to shortages of funds for the Park District. Improvements funded by the assessments are over and above the previously declining baseline level of service. The formula below describes the relationship between the final level of improvements, the existing baseline level of service, and the enhanced level of improvements to be funded by the proposed assessment.

$$\text{Final Level of Improvements} = \text{Baseline Level of Improvements} + \text{Enhanced Level of Improvements}$$

Summary of District's Improvement Plans

Projects have been chosen throughout the Park District in order to ensure that all properties in the narrowly drawn Park District boundaries will receive improved access to better maintained and improved parks in their area. A detailed project improvement plan has been developed and is available for review at the Park District offices.

Table 1 - Estimate of Cost, FY 2024-25

	Total Budget	
Installation, Maintenance & Servicing Costs		
Capital Improvements	\$1,758,932	
Equipment and Facility Replacement	\$70,000	
Services and Supplies	\$2,562,027	
Maintenance and Operations of Improvements ¹	<u>\$2,404,983</u>	
Subtotal - Installation, Maintenance and Servicing	\$6,795,942	
Administrative Costs:		
Assessment Administration and County Charges	\$29,226	
Allowance for Uncollectible Assessments	<u>\$10,791</u>	
Subtotals - Incidentals	\$40,017	
Total for Installation, Maintenance, Servicing and Administration	\$6,835,959	
Total Benefit of Improvements	\$6,835,959	
Single Family Equivalent Units (SFE)	28,558	
Benefit Received per SFE Unit	\$239.37	
Less:		
District Contribution for General Benefits ²	(\$1,708,990)	
District Contribution for Special Benefits	(\$3,808,871)	
Beginning Fund Balance (July 1, 24)	(\$1,354,670)	
Contribution to Reserve Fund/Improvement Fund/Contingency ³	<u>\$1,394,775</u>	
	(\$5,477,756)	
Net Cost of Installation, Maintenance and Servicing (Net Amount to be Assessed)	\$1,358,203	
Budget Allocation to Property		
Total Assessment Budget*	\$1,358,203	
	Unadjusted	Adjusted
	SFE	SFE
Single Family Equivalent Benefit Units - Zone A	27,539.11	27,539.11
Single Family Equivalent Benefit Units - Zone B	440.44	110.11
Single Family Equivalent Benefit Units - Zone C	1,816.89	<u>908.45</u>
Adjusted SFE Units		28,557.67
Assessment per Single Family Equivalent Unit		\$47.56

* All assessments are rounded to lower even penny. Therefore, the budget amount may slightly differ from the assessment rate

Notes to Estimate of Cost:

1. The item, Maintenance and Operation of Improvements provides funding for enhanced maintenance of all parks and recreation facilities on a daily basis, seven days per week. Improvements include mowing turf, trimming and caring for landscaping, fertilization and aeration of grounds and playfields, routine maintenance and safety inspections, painting, replacing/repairing broken or damaged equipment, trash removal and cleanup, irrigation and irrigation system maintenance, and other services as needed.
2. As determined in the following section, at least 25% of the cost of Improvements must be funded from sources other than the assessments to cover any general benefits from the Improvements. Therefore, out of the total cost of Improvements of \$6,835,959, the District must contribute at least \$1,708,990 from sources other than the assessments. The District will contribute much more than this amount, which more than covers any general benefits from the Improvements.
3. This amount is the projected ending fund balance as of June 30, 2025. The Fund Balance shown includes operating reserves and the Capital Improvement Reserve Fund.
4. The Act stipulates that proceeds from the assessments must be deposited into a special fund that has been set up for the revenues and expenditures of the Improvement District. Moreover, funds raised by the assessment shall be used only for the purposes stated within this Report. Any balance remaining at the end of the fiscal year, July 1, must be carried over to the next fiscal year. The funds shown under contribution to Reserve Fund / Improvement Fund / Contingency are primarily being accumulated for future capital improvement and capital renovation needs.

Method of Apportionment

Method of Apportionment

This section of the Engineer's Report explains the special and general benefits to be derived from the Improvements to park facilities and District maintained property throughout the Park District, and the methodology used to apportion the total assessment to properties within the Improvement District.

The Improvement District consists of all Assessor Parcels within the boundaries of the Pleasant Valley Recreation and Park District. The method used for apportioning the assessment is based upon the proportional special benefits conferred to the properties over and above the general benefits conferred to real property in the Improvement District or to the public at large. Special benefit is calculated for each parcel in the Improvement District using the following process:

1. Identification of all benefit factors derived from the Improvements
2. Identification of the direct advantages (special benefits) received by property in the Improvement District
3. Calculation of the proportion of these benefits that are general
4. Determination of the relative special benefit within different areas within the Improvement District
5. Determination of the relative special benefit per property type
6. Calculation of the specific assessment for each individual parcel based upon special vs. general benefit; location, property type, property characteristics, improvements on property and other supporting attributes

Discussion of Benefit

In summary, the assessments can only be levied based on the special benefit to property. Any and all general benefit must be funded from another source. This special benefit is received by property over and above any general benefits from the Improvements. With reference to the requirements for assessments, Section 22573 of the Landscaping and Lighting Act of 1972 states:

"The net amount to be assessed upon lands within an assessment district may be apportioned by any formula or method which fairly distributes the net amount among all assessable lots or parcels in proportion to the estimated benefits to be received by each such lot or parcel from the improvements."

“The determination of whether or not a lot or parcel will benefit from the improvements shall be made pursuant to the Improvement Act of 1911 (Division 7 (commencing with Section 5000)) [of the Streets and Highways Code, State of California].”

Proposition 218, as codified in Article XIII D of the California Constitution, has confirmed that assessments must be based on the special benefit to property:

“No assessment shall be imposed on any parcel which exceeds the reasonable cost of the proportional special benefit conferred on that parcel.”

Since assessments are levied on the basis of special benefit, they are not a tax and are not governed by Article XIII A of the California Constitution.

The SVTA v. SCCOSA decision also clarifies that a special benefit is a service or improvement that provides a direct advantage to a parcel, in contrast to a general benefit which provides indirect or derivative advantages. The SVTA v. SCCOSA decision also provides specific guidance that park improvements are a direct advantage and special benefit to property that is proximate to a park that is improved by an assessment:

the characterization of a benefit may depend on whether the parcel receives a direct advantage from the improvement (e.g. proximity to a park) or receives an indirect, derivative advantage resulting from the overall public benefits of the improvement (e.g. general enhancement of the district’s property values).

Finally, Proposition 218 twice uses the phrase “over and above” general benefits in describing special benefit. (Art. XIII D, sections 2(i) & 4(f).) The SVTA v. SCCOSA decision further clarifies that special benefits must provide a direct advantage to benefiting property and that examples of a special benefit include proximity to a park, expanded or improved access to open space or views of open space.

Benefit Factors

The special benefits from the Improvements are listed below:

Extension of a property's outdoor areas and green spaces for properties within close proximity to the Improvements

In large part because it is cost prohibitive to provide large open land areas on property in the Improvement District, the residential, commercial and other benefiting properties in the Improvement District do not have large outdoor areas and green spaces. The parks in the Improvement District provide these larger outdoor areas that serve as an effective extension of the land area for proximate properties because the Improvements are uniquely proximate and accessible to property in close proximity to the Improvements. The Improvements, therefore, provide an important, valuable and desirable extension of usable land area for the direct advantage and special benefit of properties with good and close proximity to the Improvements.

According to the industry-standard guidelines established by the National Park and Recreation Association (the "NPRA"), neighborhood parks in urban areas have a service area radius of generally one-half mile and community parks have a service area radius of approximately two miles. The service radii for neighborhood parks and neighborhood green spaces were specifically established to give all properties within this service radii close proximity and easy access to such public land areas. Since proximate and accessible parks serve as an extension of the usable land area for property in the service radii and since the service radii was specifically designed to provide close proximity and access, the parcels within this service area clearly receive a direct advantage and special benefit from the Improvements - and this advantage is not received by other properties or the public at large.

Moreover, almost every neighborhood park in the Improvement District does not provide a restroom or parking lot. Such public amenities were specifically excluded from neighborhood parks because neighborhood parks are designed to be an extension of usable land area specifically for properties in close proximity, and not the public at large or other non-proximate property. The occupants of proximate property do not need to drive to their local park and do not need restroom facilities because they can easily reach their local neighborhood park and can use their own restroom facilities as needed. This is further tangible evidence of the effective extension of land area provided by the Improvements to proximate parcels in the Improvement District and the unique direct advantage the parcels within the Improvement District receive from the Improvements.

An analysis of the service radii for the Improvements finds that all properties in the Improvement District enjoy the distinct and direct advantage of being close and proximate to parks within the Improvement District. As noted in the following section, several Zones of Benefit have been specifically drawn within the Improvement District to further recognize the unique levels of proximity and special benefits to properties in the Improvement District. The benefiting properties in the Improvement District therefore uniquely and specially benefit from the Improvements and several unique areas of special benefits have been narrowly drawn.

Proximity to improved parks and recreational facilities

Only the specific properties within close proximity to the Improvements are included in the Improvement District. Therefore, property in the Improvement District enjoys unique and valuable proximity and access to the Improvements that the public at large and property outside the Improvement District do not share.

In absence of the assessments, the Improvements would not be provided and the parks and recreation areas in the Improvement District would be degraded due to insufficient funding for maintenance, upkeep and repair. Therefore, the assessments provide Improvements that are over and above what otherwise would be provided. Improvements that are over and above what otherwise would be provided do not by themselves translate into special benefits but when combined with the unique proximity and access enjoyed by parcels in the Improvement District, they provide a direct advantage and special benefit to property in the Improvement District.

Access to improved parks, open space and recreational areas

Since the parcels in the Improvement District are nearly the only parcels that enjoy close access to the Improvements, they directly benefit from the unique close access to improved parks, open space and recreation areas that are provided by the Assessments. This is a direct advantage and special benefit to property in the Improvement District.

Improved Views

The Park District, by maintaining the landscaping at its park, recreation and open space facilities provides improved views to properties with direct line-of-sight as well as other local properties which benefit from improved views when is the Improvements are accessed or passed. Therefore, the improved and protected views provided by the Assessments are another direct and tangible advantage that is uniquely conferred upon property in the Improvement District.

Benefit Finding

In summary, real property located within the boundaries of the Improvement District distinctly and directly benefits from closer proximity, access and views of improved parks, recreation facilities, open space, landscaped corridors, greenbelts, trail systems and other public resources funded by the Assessments. The Improvements are specifically designed to serve local properties in the Improvement District, not other properties or the public at large. The public at large and other properties outside the Improvement District receive only limited benefits from the Improvements because they do not have proximity, good access or views of the Improvements. These are special benefits to property in the Improvement District in much the same way that sewer and water facilities, sidewalks and paved streets enhance the utility and desirability of property and make them more functional to use, safer and easier to access.

General versus Special Benefit

Article XIII C of the California Constitution requires any local agency proposing to increase or impose a benefit assessment to “separate the general benefits from the special benefits conferred on a parcel.” The rationale for separating special and general benefits is to ensure that property owners subject to the benefit assessment are not paying for general benefits. The assessment can fund special benefits but cannot fund general benefits. Accordingly, a separate estimate of the special and general benefit is given in this section.

In other words:

$$\text{Total Benefit} = \text{General Benefit} + \text{Special Benefit}$$

There is no widely-accepted or statutory formula for general benefit. General benefits are benefits from improvements or services that are not special in nature, are not “particular and distinct” and are not “over and above” benefits received by other properties. SVTA vs. SCCOSA provides some clarification by indicating that general benefits provide “an indirect, derivative advantage” and are not necessarily proximate to the improvements.

In this report, the general benefit is conservatively estimated and described, and then budgeted so that it is funded by sources other than the assessment.

The starting point for evaluating general and special benefits is the current, baseline level of service. The assessment will fund Improvements “over and above” this general, baseline level and the general benefits estimated in this section are over and above the baseline.

A formula to estimate the general benefit is listed below:

General Benefit	=	Benefit to real property outside of improvement district	+	Benefit to real property inside of improvement district	+	Benefit to public at large
----------------------------	----------	---	----------	--	----------	---

Special benefit, on the other hand, is defined in the state constitution as “a particular and distinct benefit over and above general benefits conferred on real property located in the district or to the public at large.” The SVTA v. SCCOSA decision indicates that a special benefit is conferred to a property if it “receives a direct advantage from the improvement (e.g., proximity to a park).” In this assessment, as noted, properties in the Improvement District have close and unique proximity, views and access to the Improvements and uniquely improved desirability from the Improvements. Other properties and the public at large do not receive significant benefits because they do not have proximity, access or views of the Improvements. Therefore, the overwhelming proportion of the benefits conferred to property is special, and is only minimally received by property outside the Improvement District or the public at large.

In the 2009 Dahms case, the court upheld an assessment that was 100% special benefit on the rationale that the services funded by the assessments were directly provided within the assessment district. It is also important to note that the improvements and services funded by the assessments in Pomona are similar to the improvements and services funded by the Assessments described in this Engineer’s Report and the Court found these improvements and services to be 100% special benefit. Also similar to the assessments in Pomona, the Assessments described in this Engineer’s Report fund improvements and services directly provided within the Assessment District and every benefiting property in the Assessment District enjoys proximity and access to the Improvements. Therefore, Dahms establishes a basis for minimal or zero general benefits from the Assessments. However, in this Report, the general benefit is more conservatively estimated and described, and then budgeted so that it is funded by sources other than the Assessment.

Calculating General Benefit

In this section, the general benefit is conservatively estimated and described, and then budgeted so that it is funded by sources other than the assessment.

Benefit to Property Outside the Improvement District

Properties within the Improvement District receive almost all of the special benefits from the Improvements because properties in the Improvement District enjoy unique close proximity and access to the Improvements that is not enjoyed by other properties or the public at large. However, certain properties within the proximity/access radius of the Improvements, but outside of the boundaries of the Improvement District, may receive some benefit from the Improvements. Since this benefit is conferred to properties outside the Improvement District boundaries, it contributes to the overall general benefit calculation and will not be funded by the Assessments.

The properties outside the Improvement District and within the proximity radii for neighborhood parks in the Improvement District receive benefits from the Improvements. Since these properties are not assessed for their benefits because they are outside of the area that can be assessed by the District, this is form of general benefit to the public at large and other property. A 50% reduction factor is applied to these properties because they are geographically on only one side of the Improvements and are over twice the average distance from the Improvements compared to properties in the Assessment District. The general benefit to property outside of the Improvement District is calculated as follows with the parcel and data analysis performed by SCI Consulting Group.

Assumptions:

3,616 parcels outside the district but within either 0.5 miles of a neighborhood park or 2.0 miles of a community park within the Improvement District.

25,370 parcels in the Improvement District.

50% relative benefit compared to property within the Improvement District.

Calculation of General Benefit to Property Outside the Improvement District

$$(3,616 / (25,370 + 3,615)) * 0.5 = 6.2\%$$

Although it can reasonably be argued that Improvements inside, but near the Park District boundaries are offset by similar park and recreational improvements provided outside, but near the Park District's boundaries, we use the more conservative approach of finding that 6.2% of the Improvements may be of general benefit to property outside the Improvement District.

Benefit to Property *Inside* the District that is *Indirect and Derivative*

The "indirect and derivative" benefit to property within the Improvement District is particularly difficult to calculate. A solid argument can be presented that all benefit within the Improvement District is special, because the Improvements are clearly "over and above" and "particular and distinct" when compared with the baseline level of service and the unique proximity, access and views of the Improvements enjoyed by benefiting properties in the Improvement District.

Nevertheless, the SVTA vs. SCCOSA decision indicates there may be general benefit "conferred on real property located in the district". A measure of the general benefits to property within the Assessment area is the percentage of land area within the Improvement District that is publicly owned and used for regional purposes such as major roads, rail lines and other regional facilities because such properties used for regional purposes could provide indirect benefits to the public at large. Approximately 2.0% of the land area in the Improvement District is used for such regional purposes, so this is a measure of the general benefits to property within the Improvement District.

Benefit To The Public At Large

The general benefit to the public at large can be estimated by the proportionate amount of time that the Park District's parks and recreational facilities are used and enjoyed by individuals who are not residents, employees, customers or property owners in the Park District¹. A survey of park and recreation facility usage conducted by SCI Consulting Group found that less than 5% of the Park District's facility usage is by those who do not live or work within District boundaries.² When people outside the Improvement District use parks, they diminish the availability of parks for people within the Improvement District. Therefore, another 5% of general benefits are allocated for people within the Improvement District. Combining these two measures of general benefits, we find that 10% of the benefits from the Improvements are general benefits to the public at large.

¹ . When District facilities are used by those individuals, the facilities are not providing benefit to property within the Park District. Use under these circumstances is a measure of general benefit. For example, a non-resident who is drawn to utilize the Park District facilities and shops at local businesses while in the area would provide special benefit to business properties as a result of his or her use of the Improvements. Conversely, one who uses Park District facilities but does

Total General Benefits

Using a sum of these three measures of general benefit, we find that approximately 18.2% of the benefits conferred by the Improvements may be general in nature and should be funded by sources other than the assessment.

General Benefit Calculation	
6.2%	(Outside the Assessment District)
+ 2.0%	(Inside the district – indirect and derivative)
+ 10.0%	(Public at Large)
= 18.2%	(Total General Benefit)

Although this analysis finds that 18.2% of the assessment may provide general benefits, the Assessment Engineer establishes a requirement for a minimum contribution from sources other than the assessments of 25%. This minimum contribution above the measure of general benefits will serve to provide additional coverage for any other general benefits.

The Park District's total budget for maintenance and improvement of its parks and recreational facilities is \$6,835,959. Of this total budget amount, the Park District will contribute \$5,517,861 from sources other than the assessments for park maintenance and operation. This contribution by the Park District equates to approximately 81% of the total budget for maintenance and improvements and constitutes far more than the amount attributable to the general benefits from the Improvements.

not reside, work, shop or own property within the Park District boundaries does not provide special benefits to any property and is considered to be a measure of the general benefits.

². A total of 200 park users were surveyed on different days and times during the months of November and December 2000. Nine respondents (4.5%) indicated that they did not reside or work within the Park District.

Zones of Benefit

The Pleasant Valley Recreation and Park District's parks and recreation facilities are generally concentrated in the areas encompassing the City of Camarillo. The outlying, generally more rural areas of the Park District have limited park and recreation facilities and properties in these areas (collectively "area") are generally less proximate to the Improvements. Therefore, this area receives relatively lesser special benefits from the assessments than properties located within the City of Camarillo. This area of lesser benefit is defined to include all parcels within District boundaries that are located outside of the City limits, excluding the upper northwest section of the unincorporated areas of the Park District, generally known as the Heights and Spanish Hills³. This area is hereinafter referred to as Zone of Benefit B or Zone B and is depicted on the Assessment Diagram included with this Report. All parcels within the City of Camarillo or within the unincorporated areas described as the Heights or Spanish Hills are classified into Zone of Benefit A or Zone A.

Relative proximity and access to the Park District's facilities is a measure of the level of special benefit conferred by the assessments. Parcels in Zone B are approximately four times farther removed from the Park District's facilities as those within Zone A; therefore these properties are determined to receive 1/4 (25%) the level of benefit as those within Zone A.

Leisure Village and The Springs are two retirement communities generally located on the eastern side of the City of Camarillo. Both communities provide their own recreational facilities and programs to their residents, and the Park District does not own or maintain facilities within the two communities. Consequently, the recreational facilities and services offered by Leisure Village and The Springs offset some of the benefits provided by the Park District's facilities, so these properties receive lower levels of special benefit. Although the residents and employees of Leisure Village and The Springs use facilities within each community, they also can and do utilize the Park District's facilities and programs, such as the Senior Center, Community Center, and Pleasant Valley pool.

³ . The area of Heights and Spanish Hills is generally located in the northwest unincorporated section of the Park District. The Las Posas Equestrian Park and Springville Park is located within this area. In addition, this area has similar proximity to the Park District's parks and facilities as do other parcels within the City of Camarillo.

A survey of property owners conducted by Godbe Research and Analysis in August 2000, found that property owners in these communities utilized Park District facilities generally approximately at one-half the frequency of property owners outside these communities. Using relative frequency of use as a measure of benefit, the Engineer has determined that a benefit of 1/2 the level of benefit as those within Zone A is appropriate. Therefore, properties in Leisure Village and The Springs are classified into Zone of Benefit C or Zone C and are determined to receive a benefit of 1/2 (50%) the level of benefit as those within Zone A.

The summary of parcels and assessments by Zone of Benefit is listed in the following table.

Table 2 - Summary of Parcels and Assessments by Zone of Benefit

	<i>Zone of Benefit</i>			<i>Total</i>
	<i>A</i>	<i>B</i>	<i>C</i>	
Total Parcels	23,733	691	2,398	26,822
SFE Units (Unadjusted for Benefit Weighting)	27,539.11	440.44	1,816.89	29,796.44
Benefit Adjustment Factor	100%	25%	50%	
Assessment Rate per SFE	\$47.56	\$11.89	\$23.78	
Total Assessment	\$1,309,760	\$5,237	\$43,206	\$1,358,203

The Zones of Benefit are shown on the Assessment Diagram and are listed for each parcel on the Assessment Roll.

Assessed properties within the Improvement District are within the industry-accepted proximity/service area for parks and recreation facilities. As noted, these proximity radii were specifically established to only encompass properties with good proximity and access to local parks and in effect make local parks within the proximity radii an extension of usable land area for the properties in the area. Since all parcels in the Improvement District have good access and proximity to the Improvements and the benefits to relatively closer proximity are offset by other factors, additional proximity is not considered to be a factor in determining benefit within each Zone of Benefit. In other words, the boundaries of the Improvement District and the Zones of Benefit have been narrowly drawn to include only properties that have good proximity and access and will specially benefit from the Improvements.

The SVTA vs. SCCOSA, 44 Cal.4th 431, 456, decision indicates:

In a well-drawn district — limited to only parcels receiving special benefits from the improvement — every parcel within that district receives a shared special benefit. Under section 2, subdivision (i), these benefits can be construed as being general benefits since they are not “particular and distinct” and are not “over and above” the benefits received by other properties “located in the district.”

We do not believe that the voters intended to invalidate an assessment district that is narrowly drawn to include only properties directly benefiting from an improvement. Indeed, the ballot materials reflect otherwise. Thus, if an assessment district is narrowly drawn, the fact that a benefit is conferred throughout the district does not make it general rather than special. In that circumstance, the characterization of a benefit may depend on whether the parcel receives a direct advantage from the improvement (e.g., proximity to park) or receives an indirect, derivative advantage resulting from the overall public benefits of the improvement (e.g., general enhancement of the district’s property values).

In the Improvement District, the advantage that each parcel receives from the Improvements is direct, and the boundaries are narrowly drawn to include only parcels that benefit from the assessment. Therefore, the even spread of assessment throughout each narrowly drawn Zone of Benefit is indeed consistent with the SVTA vs. SCCOSA decision and satisfies the “direct relationship to the ‘locality of the improvement.’” standard.

Method of Assessment and Proportionality

As previously discussed, the assessments provide specific Improvements that confer direct and tangible special benefits to properties in the Improvement District. These benefits can partially be measured by the occupants on property in the Improvement District because such parcel population density is a measure of the relative benefit a parcel receives from the Improvements. Therefore, the apportionment of benefit is partially based the population density of parcels.

It should be noted that many other types of “traditional” assessments also use parcel population densities to apportion the assessments. For example, the assessments for sewer systems, roads and water systems are typically allocated based on the population density of the parcels assessed. Moreover, assessments have a long history of use in California and are in large part based on the principle that benefits from a service or improvement funded by assessments that is enjoyed by tenants and other non-property owners ultimately is conferred directly to the underlying property.⁴

The next step in apportioning assessments is to determine the relative special benefit for each property. This process involves determining the relative benefit received by each property in relation to a single family home, or, in other words, on the basis of Single Family Equivalents (SFE). This SFE methodology is commonly used to distribute assessments in proportion to estimated special benefit and is generally recognized as providing the basis for a fair and appropriate distribution of assessments. For the purposes of this Engineer’s Report, all properties are designated a SFE value, which is each property’s relative benefit in relation to a single family home on one parcel. In this case, the “benchmark” property is the single family detached dwelling which is one Single Family Equivalent or one SFE.

In the process of determining the appropriate method of assessment, the Engineer considered various alternatives. For example, an assessment only for all residential improved property was considered but was determined to be inappropriate because commercial, industrial and other properties also receive direct benefits from the Improvements.

⁴ For example, in *Federal Construction Co. v. Ensign (1922) 59 Cal.App. 200 at 211*, the appellate court determined that a sewer system specially benefited property even though the direct benefit was to the people who used the sewers: “Practically every inhabitant of a city either is the owner of the land on which he resides or on which he pursues his vocation, or he is the tenant of the owner, or is the agent or servant of such owner or of such tenant. And since it is the inhabitants who make by far the greater use of a city’s sewer system, it is to them, as lot owners or as tenants, or as the servants or agents of such lot owners or tenants, that the advantages of actual use will redound. But this advantage of use means that, in the final analysis, it is the lot owners themselves who will be especially benefited in a financial sense.”

Moreover, a fixed or flat assessment for all properties of similar type was deemed to be inappropriate because larger properties receive a higher degree of benefit than other similarly used properties that are significantly smaller. (For two properties used for commercial purposes, there is clearly a higher benefit provided to the larger property in comparison to a smaller commercial property because the larger property generally supports a larger building and has higher numbers of employees, customers and guests that would benefit from proximity and improved access to well maintained and improved parks and recreational facilities. So the potential population of employees or residents is a measure of the special benefits received by the property.) Larger parcels, therefore, receive an increased benefit from the assessments.

Finally, the special benefits derived from the assessments are conferred on property and are not based on a specific property owner's use of the improvements, or a specific property owner's occupancy of property or the property owner's demographic status such as age or number of dependents. However, it is ultimately people who value the special benefits described above and use and enjoy the Park District's park and recreational facilities. In other words, the benefits derived to property are related to the average number of people who could potentially live on, work at, or otherwise could use a property, not how the property is currently used by the present owner. Therefore, the number of people who could or potentially live on, work at or otherwise use a property is one indicator of the relative level of benefit received by a property.

In conclusion, the Assessment Engineer determined that the appropriate method of assessment apportionment should be based on the type and use of property, the relative size of the property, its relative population and usage potential, its location and its proximity to parks and recreational facilities. Furthermore, the proportional special benefit derived by each identified parcel is apportioned based upon the following:

1. The entirety of the capital cost of the Improvements;
2. The maintenance and operation expenses of the Improvements;
3. And the cost of the property-related service being provided.

This method is further described below.

Pursuant to the Landscape and Lighting Act of 1972 and Article XIID of the Constitution of the State of California, all parcels that have special benefit conferred upon them as a result of the Improvements shall be identified and the proportionate special benefit derived by each identified parcel shall be determined in relationship to the entire cost of the Improvements. Only parcels that receive direct special benefit are assessed, and each parcel is assessed in proportion to the estimated benefit received.

Each parcel's benefit is determined by the difference between the general and special benefits being conferred on the properties by the Improvements; and the proportion of the special benefit conferred on the various land uses within the Assessment District. This method is further depicted below.

Equation 1 – Special Benefit Apportionment Factors

$$\text{Special Benefit} \approx \sum (\text{Special Benefit apportionment factors including use property type, size, location, and proximity to Improvements})$$

The next step in apportioning assessments is to determine the relative special benefit for each property. This process involves determining the relative benefit received by each property in relation to a "benchmark" property, a single family detached dwelling on one parcel (one "Single Family Equivalent Unit" or "SFE"). This SFE methodology is commonly used to distribute assessments in proportion to estimated special benefits and is generally recognized as providing the basis for a fair and appropriate distribution of assessments. In this Engineer's Report, all properties are assigned an SFE value, which is each property's relative special benefit in relation to a single family home on one parcel (the benchmark parcel). The formula for this special benefit assignment is as follows.

Equation 2 – Relative Special Benefit (SFE)

$$\text{Relative Special Benefit} \approx \frac{\text{Special Benefit for a Specific Parcel}}{\text{Special Benefit for the Benchmark Parcel}}$$

Finally, to apportion the cost of Improvements to each parcel the total cost of the Improvements funded by the Assessments is divided by the total SFE benefit units assigned to all parcels. The resulting rate per SFE unit is then multiplied by the SFE units assigned to a parcel to determine the proportional assessment for each parcel.

Equation 3 – Assessment Apportionment

$$\text{Assessment for Parcel} = \frac{\text{Entire Cost of Improvements}}{\text{Total SFE Benefit Units}} * (\text{SFE Benefit Units for Parcel})$$

Method of Apportionment

Residential Properties

Certain residential properties in the Improvement District that contain a single residential dwelling unit are assigned one Single Family Equivalent or 1.0 SFE. Traditional houses, zero-lot line houses and townhomes are included in this category.

Properties with more than one residential unit are designated as multi-family residential properties. These properties benefit from the improvements in proportion to the number of dwelling units that occupy each property and the average number of people who reside in multi-family residential units versus the average number of people who reside in a single family home. The population density factors for the Pleasant Valley Recreation and Park District, as depicted below, provide the basis for determining the SFE factors for residential properties. Using the total population in a certain property type in the area of the Park District from the 1990 Census and dividing it by the total number of such households, finds that approximately 3.32 persons occupy each single family residence, whereas an average of 2.16 persons occupy each multi-family residence. Using the ratio of one SFE for each single-family residence, which equates to one SFE for every 3.32 persons, 0.65 SFE would equate to one multi-family unit or 0.65 SFE for every 2.16 residents. Likewise, each condominium unit receives 0.71 SFE and each mobile home receives 0.51 SFE.

Table 3 - Residential Density and Assessment Factors

	<i>Total Population</i>	<i>Occupied Households</i>	<i>Persons per Household</i>	<i>SFE Factor</i>
Single Family Residential	34,333	10,343	3.32	1.00
Condominium	9,464	4,030	2.35	0.71
Multi-Family Residential	5,633	2,602	2.16	0.65
Mobile Home on Separate Lot	1,712	1,014	1.69	0.51

Source: 1990 Census, city of Camarillo (the most recent data available when the Improvement District was established).

The single family equivalency factor of 0.65 per dwelling unit for multifamily residential properties applies to such properties with 20 or fewer units. Properties in excess of 20 units typically offer on-site recreational amenities and other facilities that tend to offset some of the benefits provided by the improvements. Therefore the benefit for properties in excess of 20 units is determined to be 0.65 SFE per unit for the first 20 units and 0.10 SFE per each additional unit in excess of 20 dwelling units.

Commercial/Industrial Properties

SFE values for commercial and industrial land uses are based on the equivalence of special benefit on a land area basis between single family residential property and the average commercial/industrial property. The SFE values for various commercial and industrial land uses are further defined by using average employee densities because the special benefit factors described previously can be measured by the average number of people who work at commercial/industrial properties.

In order to determine employee density factors, the findings from the San Diego Association of Governments Traffic Generators Study (the "SANDAG Study") are used because these findings were approved by the State Legislature as being a good representation of the average number of employees per acre of land area for commercial and industrial properties. As determined by the SANDAG Study, the average number of employees per acre for commercial and industrial property is 24.

In comparison, the average number of people residing in a single family home in the area is 3.32. Since the average lot size for a single family home in the Park District is approximately 0.27 acres, the average number of residents per acre of residential property is 12.30.

The employee density per acre is generally 2 times the population density of single family residential property per acre (24 employees per acre / 12.3 residents per acre). Therefore, the average employee density can be used as the basis for allocating benefit to commercial or industrial property since a commercial/industrial property with 2 employees receives generally similar special benefit to a residential property with 1 resident. This factor of equivalence of benefit between 1 resident to 2 employees is the basis for allocating commercial/industrial benefit. Table 4 shows the average employees per acre of land area or portion thereof for commercial and industrial properties and lists the relative SFE factors per quarter acre for properties in each land use category.

Commercial and industrial properties in excess of 5 acres generally involve uses that are more land intensive relative to building areas and number of employees (lower coverage ratios). As a result, the benefit factors for commercial and industrial property land area in excess of 5 acres is determined to be the SFE rate per quarter acre for the first 5 acres and the relevant SFE rate per each additional acre over 5 acres.

Institutional properties that are used for residential, commercial or industrial purposes are also assessed at the appropriate residential, commercial or industrial rate.

Table 4 - Commercial/Industrial Density and Assessment Factors

<i>Type of Commercial/Industrial Land Use</i>	<i>Average Employees Per Acre ¹</i>	<i>SFE Units per 1/4 Acre ²</i>
Commercial	24	1.00
Office	68	2.83
Shopping Center	24	1.00
Industrial	24	1.00
Self Storage or Parking Lot	1	0.04

1. Source: San Diego Association of Governments Traffic Generators Study.

2. The SFE factors for commercial and industrial parcels are applied by the quarter acre of land area or portion thereof. (Therefore, the minimum assessment for any assessable parcel in these categories is the SFE Units listed herein.)

Vacant Properties

The benefit to vacant properties is determined to be proportional to the corresponding benefits for similar type developed properties; however, at a lower rate due to the lack of improvements on the property. A measure of the benefits accruing to the underlying land is the average value of land in relation to improvements for developed property. An analysis of the Fiscal Year 2000-01 assessed valuation data from the County of Ventura, found that 35% of the assessed value of improved properties is classified as the land value. It is reasonable to assume, therefore, that approximately 35% of the benefits are related to the underlying land and 65% are related to the improvements and the day to day use of the property. Using this ratio, the SFE factor for vacant parcels is 0.35 per parcel.

As properties are approved for development, their value increases. Likewise, the special benefits received by vacant property increases as the property is approved for development, or becomes closer to being improved. When property is approved for development with a final map, the property has passed the final significant hurdle to development and can shortly undergo construction. Since the property is nearing the point of development, its special benefits increase. In addition, these properties are generally sold soon after completion of improvements, so the properties receive the additional benefit of desirability from prospective buyers due to the special benefits provided by proximity to improved parks and recreational facilities of the Park District. It is therefore determined that property with final map approval receives 50% of the relative benefit to improved property of similar use-type.

Other Properties

Article XIID provides that publicly owned properties must be assessed unless there is clear and convincing evidence that those properties receive no special benefit from the assessment.

All properties that are specially benefited are assessed. Other publicly owned property that is used for business purposes similar to private residential, commercial, industrial or institutional uses is benefited and assessed at the same rate as such privately owned property.

Miscellaneous, small and other parcels such as roads, right-of-way parcels, and common areas typically do not generate significant numbers of employees, residents, customers or guests and have limited economic value. These miscellaneous parcels receive minimal benefit from the Improvements and are assessed an SFE benefit factor of 0.

Duration of Assessment

As noted previously, the Board gained the authority to approve the levy of the assessments for the fiscal year 2001-02 and to continue to levy them in future years. It is proposed that the Assessment be levied for fiscal year 2024-25 and continued every year thereafter, so long as the parks and recreational areas need to be improved and maintained. Pleasant Valley Recreation and Park District requires funding from the Assessments for its Improvements in the Improvement District. The Assessment can continue to be levied annually after the Pleasant Valley Recreation and Park District Board of Directors approves an annually updated Engineer's Report, budget for the Assessment, Improvements to be provided, and other specifics of the Assessment. In addition, the District Board of Directors must hold an annual public hearing to continue the Assessment.

Appeals and Interpretation

Any property owner who feels that the assessment levied on the subject property is in error as a result of incorrect information being used to apply the foregoing method of assessment, may file a written appeal with the General Manager or her or his designee. Any such appeal is limited to correction of an assessment during the then current or, if before July 1, the upcoming fiscal year. Upon the filing of any such appeal, the General Manager or his or her designee will promptly review the appeal and any information provided by the property owner. If the General Manager or her or his designee finds that the assessment should be modified, the appropriate changes shall be made to the assessment roll. If any such changes are approved after the assessment roll has been filed with the County for collection, the General Manager or his or her designee is authorized to refund to the property owner the amount of any approved reduction. Any dispute over the decision of the General Manager or her or his designee, shall be referred to the Board of the Pleasant Valley Recreation and Park District and the decision of the Board of the Pleasant Valley Recreation and Park District shall be final.

Assessment

Whereas, on February 7, 2024 the Pleasant Valley Recreation and Park District Board of Directors adopted its Resolution Designating Engineer of Work, and Directing Preparation of the Engineer's Report for the Pleasant Valley Recreation and Park District, County of Ventura, California;

Whereas, said Resolution directed the undersigned Engineer of Work to prepare and file a report presenting an estimate of costs, a diagram for the Improvement District and an assessment of the estimated costs of the improvements upon all assessable parcels within the Improvement District, to which Resolution and the description of the Improvements therein contained, reference is hereby made for further particulars;

Now, Therefore, the undersigned, by virtue of the power vested in me under said Act and the order of the Board of said Pleasant Valley Recreation and Park District, hereby make the following assessment to cover the portion of the estimated cost of the improvements, and the costs and expenses incidental thereto to be paid by the Improvement District.

The amount to be paid for the Improvements and the expense incidental thereto, to be paid by the Improvement District for the fiscal year 2024-25 is generally as follows:

Table 5 - Summary Cost Estimate

	<i>F.Y. 2024-25</i>
	<u><i>Budget</i></u>
Parks Maintenance	\$5,037,010
Parks Improvements	\$1,758,932
Contingency and Reserve	\$1,394,775
Incidental Expenses	<u>\$40,017</u>
TOTAL BUDGET	\$8,230,734
Less:	
Beginning Fund Balance (July 1, 24)	(\$1,354,670)
Park District Contribution	<u>(\$5,517,861)</u>
NET AMOUNT TO ASSESSMENTS	\$1,358,203

As required by the Act, an Assessment Diagram is hereto attached and made a part hereof showing the exterior boundaries of the Improvement District. The distinctive number of each parcel or lot of land in the said Improvement District is its Assessor Parcel Number appearing on the Assessment Roll.

I do hereby assess and apportion said net amount of the cost and expenses of said improvements, including the costs and expenses incident thereto, upon the parcels and lots of land within said Improvement District, in accordance with the special benefits to be received by each parcel or lot, from the improvements, and more particularly set forth in the Cost Estimate and Method of Assessment hereto attached and by reference made a part hereof.

The assessment is subject to an annual adjustment tied to the Consumer Price Index-U for the Los Angeles Area as of December of each succeeding year (the "CPI"), with a maximum annual adjustment not to exceed 3%. Any change in the CPI in excess of 3% shall be cumulatively reserved as the "Unused CPI" and shall be used to increase the maximum authorized assessment rate in years in which the CPI is less than 3%. The maximum authorized assessment rate is equal to the maximum assessment rate in the first fiscal year the assessment was levied adjusted annually by the minimum of 1) 3% or 2) the change in the CPI plus any Unused CPI as described above.

The change in the CPI from December 2022 to December 2023 was 3.47%. Therefore, the maximum authorized assessment rate for fiscal year 2024-25 is increased by 3.00% which equates to \$47.56 per single family equivalent benefit unit. The estimate of cost and budget in this Engineer's Report proposes assessments for fiscal year 2024-25 at the rate of \$47.56. The assessment ballot proceeding conducted in 2001 authorized an annual adjustment in the assessment levies equal to the annual change in the CPI, not to exceed 3%. The maximum authorized assessment rate for fiscal year 2024-25 is within the limits of the authorized CPI increase.

The assessment is made upon the parcels or lots of land within the Improvement District in proportion to the special benefits to be received by the parcels or lots of land, from said improvements.

Each parcel or lot of land is described in the Assessment Roll by reference to its parcel number as shown on the Assessor's Maps of the County of Ventura for the fiscal year 2024-25. For a more particular description of the property, reference is hereby made to the deeds and maps on file and of record in the office of the County Recorder of said County.

I hereby place opposite the Assessor Parcel Number for each parcel or lot within the Assessment Roll, the amount of the assessment for the fiscal year 2024-25 for each parcel or lot of land within the Improvement District.

Dated: April 4, 2024

Engineer of Work

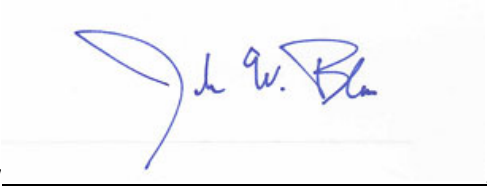

By _____
John Bliss, License No. C52091



Assessment Diagram

The Improvement District includes all properties within the boundaries of the Pleasant Valley Recreation and Park District. The boundaries of the Improvement District are displayed on the following Assessment Diagram. The lines and dimensions of each lot or parcel within the Improvement District are those lines and dimensions as shown on the maps of the Assessor of the County of Ventura, for fiscal year 2024-25, and are incorporated herein by reference, and made a part of this Diagram and this Report.

(This page intentionally left blank.)

FILED IN THE OFFICE OF THE GENERAL MANAGER OF THE PLEASANT VALLEY RECREATION AND PARK DISTRICT, COUNTY OF VENTURA, CALIFORNIA, THIS _____ DAY OF _____, 2024.

GENERAL MANAGER _____

RECORDED IN THE OFFICE OF THE GENERAL MANAGER OF THE PLEASANT VALLEY RECREATION AND PARK DISTRICT, COUNTY OF VENTURA, CALIFORNIA, THIS _____ DAY OF _____, 2024.

GENERAL MANAGER _____

AN ASSESSMENT WAS CONFIRMED AND LEVIED BY THE BOARD OF DIRECTORS OF THE PLEASANT VALLEY RECREATION AND PARK DISTRICT ON THE LOTS, PIECES AND PARCELS OF LAND ON THIS ASSESSMENT DIAGRAM ON THE _____ DAY OF _____, 2024 FOR FISCAL YEAR 2024-25 AND SAID ASSESSMENT DIAGRAM AND THE ASSESSMENT ROLL FOR SAID FISCAL YEAR WERE FILED IN THE OFFICE OF THE COUNTY AUDITOR OF THE COUNTY OF VENTURA ON THE _____ DAY OF _____, 2024. REFERENCE IS HEREBY MADE TO SAID RECORDED ASSESSMENT ROLL FOR THE EXACT AMOUNT OF EACH ASSESSMENT LEVIED AGAINST EACH PARCEL OF LAND.

GENERAL MANAGER _____

FILED THIS _____ DAY OF _____, 2024, AT THE HOUR OF _____ O'CLOCK _____ M. IN THE OFFICE OF THE COUNTY AUDITOR OF THE COUNTY OF VENTURA, STATE OF CALIFORNIA, AT THE REQUEST OF THE BOARD OF DIRECTORS OF THE PLEASANT VALLEY RECREATION AND PARK DISTRICT.

COUNTY AUDITOR, COUNTY OF VENTURA

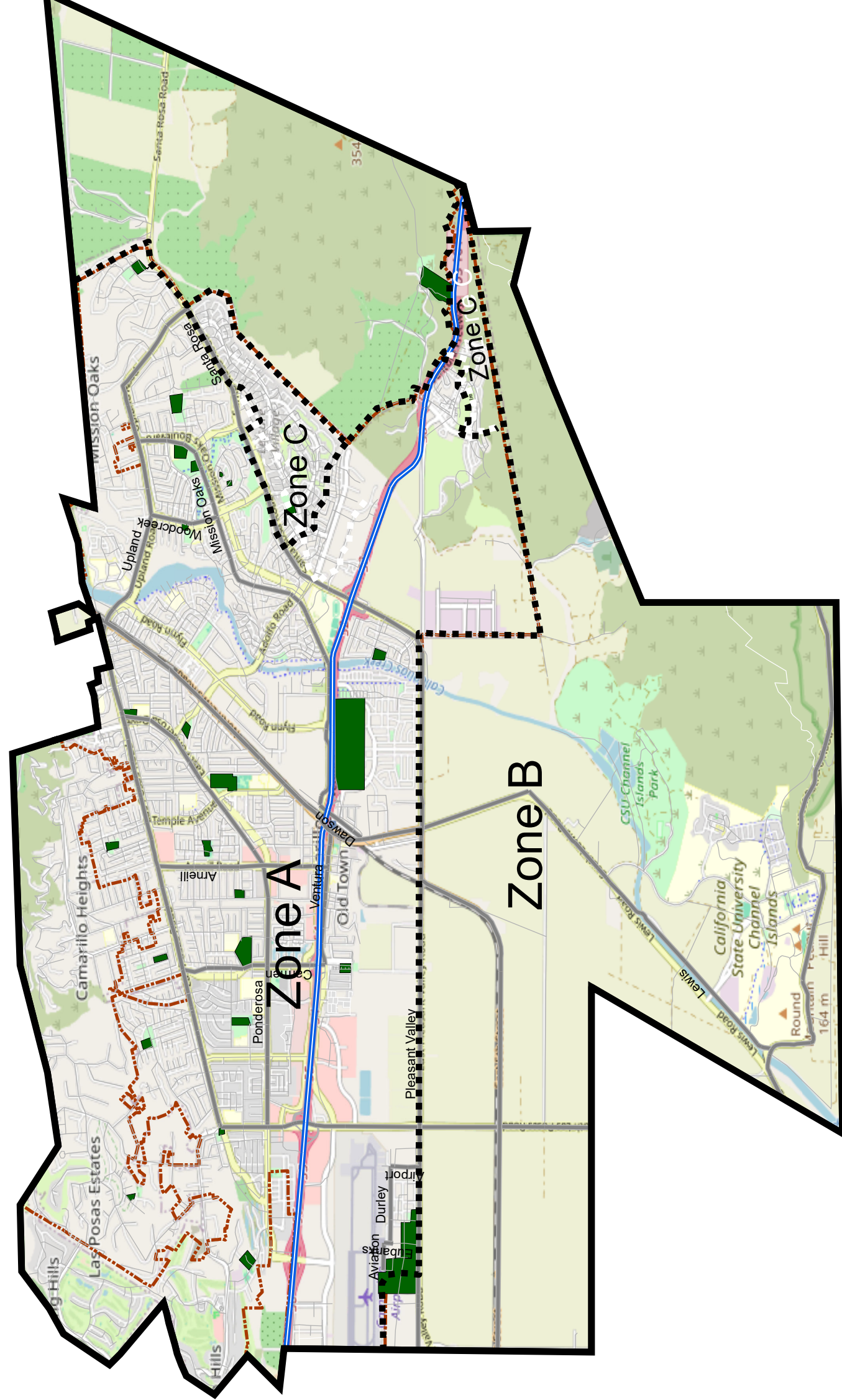

Note:
 REFERENCE IS HEREBY MADE TO THE MAPS AND DEEDS OF RECORD IN THE OFFICE OF THE ASSESSOR OF THE COUNTY OF VENTURA FOR A DETAILED DESCRIPTION OF THE LINES AND DIMENSIONS OF ANY PARCELS SHOWN HEREIN. THOSE MAPS SHALL GOVERN FOR ALL DETAILS CONCERNING THE LINES AND DIMENSIONS OF SUCH PARCELS. EACH PARCEL IS IDENTIFIED IN SAID MAPS BY ITS DISTINCTIVE ASSESSOR'S PARCEL NUMBER.

Legend

- Interstate
- Major Road
- Local Road
- Parks
- District Boundary Line
- City boundaries
- Zone of Benefit Boundary



Appendix A - 2024-25 Assessment Roll

Each lot or parcel listed on the Assessment Roll is shown and illustrated on the latest County Assessor records and these records are, by reference made part of this report. These records shall govern for all details concerning the description of the lots or parcels.

**Pleasant Valley RPD
Park Maintenance and Recreation Improvement District Assessment Summary**

FISCAL YEAR	MAX RATE	ACTUAL RATE LEVIED	ACTUAL CPI INCREASE USED	ACTUAL CPI CHANGE	UNUSED CPI	TOTAL ASSESSMENT
2001-02 Rate	\$27.00	\$27.00				\$674,157
2002-03 Rate	\$27.57	\$27.56	2001 CPI	2.07%	-0.03%	\$685,696
2003-04 Rate	\$28.40	\$28.40	2002 CPI	3.73%	0.73%	\$717,023
2004-05 Rate	\$29.12	\$29.10	2003 CPI	2.53%	-0.70%	\$735,585
2005-06 Rate	\$29.99	\$29.10	2004 CPI	3.00%	1.39%	\$751,297
2006-07 Rate	\$30.89	\$30.88	2005 CPI	3.00%	1.46%	\$810,017
2007-08 Rate	\$31.82	\$31.80	2006 CPI	3.00%	0.29%	\$852,747
2008-09 Rate	\$32.77	\$32.76	2007 CPI	3.00%	1.16%	\$882,629
2009-10 Rate	\$33.75	\$33.74	2008 CPI	3.00%	-2.89%	\$906,918
2010-11 Rate	\$34.76	\$34.76	2009 CPI	3.00%	-1.17%	\$942,344
2011-12 Rate	\$35.30	\$35.30	2010 CPI	1.58%	-0.24%	\$960,711
2012-13 Rate	\$36.06	\$36.06	2011 CPI	2.17%	0.00%	\$981,609
2013-14 Rate	\$36.76	\$36.76	2012 CPI	1.93%	0.00%	\$999,880
2014-15 Rate	\$37.18	\$37.18	2013 CPI	1.14%	0.00%	\$1,011,822
2015-16 Rate	\$37.44	\$37.44	2014 CPI	0.72%	0.00%	\$1,025,179
2016-17 Rate	\$38.20	\$38.20	2015 CPI	2.03%	0.00%	\$1,051,630
2017-18 Rate	\$38.95	\$38.95	2016 CPI	1.96%	0.00%	\$1,074,595
2018-19 Rate	\$40.12	\$40.12	2017 CPI	3.00%	0.60%	\$1,114,369
2019-20 Rate	\$41.32	\$41.32	2018 CPI	3.00%	0.24%	\$1,157,512
2020-21 Rate	\$42.56	\$42.56	2019 CPI	3.00%	-0.04%	\$1,197,923
2021-22 Rate	\$43.52	\$43.52	2020 CPI	2.25%	-0.80%	\$1,230,205
2022-23 Rate	\$44.83	\$44.83	2021 CPI	3.00%	3.56%	\$1,271,469
2023-24 Rate	\$46.17	\$46.17	2022 CPI	3.00%	1.92%	\$1,318,504
2024-25 Rate	\$47.56	\$47.56	2023 CPI	3.00%	0.47%	\$1,358,719

Unused CPI Balance 5.95%

**PLEASANT VALLEY RECREATION AND PARK DISTRICT
STAFF REPORT / AGENDA REPORT**

TO: BOARD OF DIRECTORS

FROM: MARY OTTEN, GENERAL MANAGER
By: Kathryn Drewry, Human Resources Specialist

DATE: May 1, 2024

**SUBJECT: CONSIDERATION AND ADOPTION OF RESOLUTION
NO. 761, EXPANDING THE PAID SICK LEAVE POLICY
IN THE 2022 PERSONNEL POLICY MANUAL**

BACKGROUND

On January 1, 2024, Senate Bill 616 went into effect and expanded paid sick leave (PSL) for California employers and employees. SB 616 amends Labor Code sections 245.5, 246, and 246.5, and expands mandatory paid sick leave from three days, or twenty-four hours, to five days or forty hours, whichever is more.

SB 616 enhances the Healthy Workplace Healthy Family Act of 2014 (AB 1522). This previous bill entitled an employee who works in California for 30 or more days within a year from the beginning of employment to paid sick leave. Employees, including part-time and temporary, were able to earn at least one hour of paid leave for every 30 hours worked or were provided with at least 24 hours upfront or by the 120th day of employment.

ANALYSIS

SB 616 not only increases the number of paid sick days available to employees but also extends the use of paid sick days to employees.

Key provisions of the newly expanded Healthy Workplace, Healthy Families Act of 2014:

- Raising the employer’s authorized limitations on the use of carryover sick leave to 40 hours or 5 days in each year of employment.
- Redefines “full amount of leave”: to mean five (5) days or forty (40) hours.
- Allowing eligible employees, subject to an employer’s existing paid leave or paid time off within 6 months of employment.
- An increase in total allowable accrual to eighty (80) hours or ten (10) days

In addition to increasing the minimum amount of Paid Sick Leave to forty (40) hours or five (5) days, SB 616 also provides for how employers accrue the PSL. The District can choose any of the following options:

1. Employees accrue one (1) hour of PSL for every thirty (30) hours worked;
2. District can “front load” PSL by giving employees an up-front accrual of forty (40) hours (or 5 days) of PSL at the beginning of employment and each 12 months thereafter; or

3. Employees can accrue PSL at a rate other than one (1) hour for every thirty (30) hours worked so long as the accrual is regular and results in at least 24 hours (or 3 days) of PSL by the 120th day of employment and forty (40) hours (or 5 days) of PSL by the 200th day of employment.

SB 616 permits the District to select from the aforementioned options. However, due to the bill's stringent requirements and the sporadic hours of part-time employees, the only viable choice to fulfill these criteria is option two: front-loading the accrual of forty (40) hours (or 5 days) of paid sick leave at the commencement of their employment and every twelve (12) months thereafter.

The District can require the employee to work for 90 days before taking PSL, or the District can choose to advance PSL if not yet accrued.

If the District chooses to accrue sick pay instead of front-loading it, then we can impose a maximum accrual cap of 80 hours (or 10 days) of PSL. The District can restrict employees from using more than 40 hours (or 5 days) per year of the PSL they have accrued.

The District cannot limit less than 40 hours (or 5 days) of accrued PSL to carry over, i.e., if an employee has 40 hours of unused PSL or more, at least 40 hours must be allowed to carry over to the next 12-month period.

FISCAL IMPACT

There is no fiscal impact at this time.

RECOMMENDATION

It is recommended the Board of Directors approve the updated expansion of paid sick leave.

ATTACHMENTS

- 1) Senate Bill 616 (7 pages)
- 2) Current Sick Leave Policy – Redline (1 page)
- 3) Current Sick Leave Policy – Clean (1 page)
- 4) MOU – Redline (1 page)
- 5) MOU – Clean (1 page)
- 6) Resolution 761 (5 pages)

Senate Bill No. 616

CHAPTER 309

An act to amend Sections 245.5, 246, and 246.5 of the Labor Code, relating to employment.

[Approved by Governor October 04, 2023. Filed with Secretary of State October 04, 2023.]

LEGISLATIVE COUNSEL'S DIGEST

SB 616, Gonzalez. Sick days: paid sick days accrual and use.

Existing law, the Healthy Workplaces, Healthy Families Act of 2014 (act), establishes requirements relating to paid sick days and paid sick leave, as described. The act excludes specified employees from its provisions, including an employee covered by a valid collective bargaining agreement, as described (CBA employees).

This bill would exclude railroad carrier employers and their employees from the act's provisions.

Existing law, with certain exceptions, entitles an employee to paid sick days for certain purposes if the employee works in California for the same employer for 30 or more days within a year from the commencement of employment. Existing law imposes procedural requirements on employers regarding the use of paid sick days, including by prohibiting retaliation for using paid sick days, by prohibiting the imposition of certain conditions on the use of paid sick days, and by requiring the use of paid sick days for specified health care and situations. Existing law requires the leave to be accrued at a rate of no less than one hour for every 30 hours worked, and to be available for use beginning on the 90th day of employment.

This bill would extend the above-described procedural requirements on the use of paid sick days to CBA employees.

Existing law authorizes an employer to use a different accrual method as long as an employee has no less than 24 hours of accrued sick leave or paid time off by the 120th calendar day of employment or each calendar year, or in each 12-month period. Existing law also provides that an employer may satisfy the accrual requirements by providing not less than 24 hours or 3 days of paid sick leave that is available to the employee to use by the completion of the employee's 120th calendar day of employment.

This bill would modify the employer's alternate sick leave accrual method to additionally require that an employee have no less than 40 hours of accrued sick leave or paid time off by the 200th calendar day of employment or each calendar year, or in each 12-month period. The bill would modify that satisfaction provision to authorize an employer to satisfy accrual requirements by providing, in addition to the existing criteria for satisfaction above, not less than 40 hours or 5 days of paid sick leave that is available to the employee to use by the completion of the employee's 200th calendar day of employment.

Existing law requires accrued paid sick days to carry over to the following year of employment. Existing law, however, authorizes an employer to limit an employee's use of accrued paid sick days to 24 hours or 3 days in each year of employment, calendar year, or 12-month period. Under existing law, this provision is satisfied and no accrual or carryover is required if the full amount of leave is received at the beginning

of each year of employment, calendar year, or 12-month period. Existing law defines “full amount of leave” for these purposes to mean 3 days or 24 hours.

This bill would raise the employer’s authorized limitation on the use of carryover sick leave to 40 hours or 5 days in each year of employment. The bill would redefine “full amount of leave” to mean 5 days or 40 hours.

Existing law also entitles individual providers of in-home supportive services and waiver personal care services, as defined, to paid sick days in specified amounts in accordance with minimum wage increases, up to a maximum of 24 hours or 3 days each year of employment when the minimum wage has reached \$15 per hour. Existing law authorizes the State Department of Social Services to implement and interpret these provisions.

This bill would increase the sick leave accrual rate for these providers to 40 hours or 5 days in each year of employment, beginning January 1, 2024.

Under existing law, an employer is not required to provide additional paid sick days pursuant to these provisions if the employer has a paid leave or paid time off policy, makes an amount of leave available to employees that may be used for the same purposes and under the same conditions as these provisions, and the policy satisfies one of specified conditions. Under that law, one of those conditions requires the employer to have provided paid sick leave or paid time off in a manner that results in an employee’s eligibility to earn at least 3 days or 24 hours of sick leave or paid time off within 9 months of employment.

This bill would change that condition so that the employee must be eligible to earn at least 5 days or 40 hours of sick leave or paid time off within 6 months of employment.

Under existing law, an employer has no obligation under these provisions to allow an employee’s total accrual of paid sick leave to exceed 48 hours or 6 days, provided that an employee’s rights to accrue and use paid sick leave are not otherwise limited, as specified.

This bill would increase those accrual thresholds for paid sick leave to 80 hours or 10 days.

Existing paid sick days law sets forth provisions on, among other things, compensation for accrued, unused paid sick days upon specified employment events, the lending of paid sick days to employees, written notice requirements, the calculation of paid sick leave, reasonable advance notification requirements, and payment of sick leave taken.

This bill would provide that these provisions shall preempt any local ordinance to the contrary.

The bill would include findings that changes proposed by this bill address a matter of statewide concern rather than a municipal affair and, therefore, apply to all cities, including charter cities.

DIGEST KEY

Vote: majority Appropriation: no Fiscal Committee: yes Local Program: no

BILL TEXT

THE PEOPLE OF THE STATE OF CALIFORNIA DO ENACT AS FOLLOWS:

SECTION 1. Section 245.5 of the Labor Code is amended to read:

245.5. As used in this article:

(a) “Employee” does not include the following:

(1) Except as provided in subdivision (d) of Section 246.5, an employee covered by a valid collective bargaining agreement if the agreement expressly provides for the wages, hours of work, and working conditions of employees, and expressly provides for paid sick days or a paid leave or paid time off policy that permits the use of sick days for those employees, final and binding arbitration of disputes concerning the application of its paid sick days provisions, premium wage rates for all overtime hours worked, and regular hourly rate of pay of not less than 30 percent more than the state minimum wage rate.

(2) An employee in the construction industry covered by a valid collective bargaining agreement if the agreement expressly provides for the wages, hours of work, and working conditions of employees, premium wage rates for all overtime hours worked, and regular hourly pay of not less than 30 percent more than the state minimum wage rate, and the agreement either (A) was entered into before January 1, 2015, or (B) expressly waives the requirements of this article in clear and unambiguous terms. For purposes of this subparagraph, "employee in the construction industry" means an employee performing work associated with construction, including work involving alteration, demolition, building, excavation, renovation, remodeling, maintenance, improvement, repair work, and any other work as described by Chapter 9 (commencing with Section 7000) of Division 3 of the Business and Professions Code, and other similar or related occupations or trades.

(3) An individual employed by an air carrier as a flight deck or cabin crew member that is subject to Title II of the federal Railway Labor Act (45 U.S.C. Sec. 151 et seq.), provided that the individual is provided with compensated time off equal to or exceeding the amount established in paragraph (1) of subdivision (b) of Section 246.

(4) An employee of the state, city, county, city and county, district, or any other public entity who is a recipient of a retirement allowance and employed without reinstatement into the employee's respective retirement system pursuant to either Article 8 (commencing with Section 21220) of Chapter 12 of Part 3 of Division 5 of Title 2 of the Government Code, or Article 8 (commencing with Section 31670) of Chapter 3 of Part 3 of Division 4 of Title 3 of the Government Code.

(5) An employee as defined in Section 351(d) of Title 45 of the United States Code.

(b) (1) "Employer" means any person employing another under any appointment or contract of hire and includes the state, political subdivisions of the state, and municipalities.

(2) "Employer" does not include any employer described in Section 351(a) of Title 45 of the United States Code.

(c) "Family member" means any of the following:

(1) A child, which for purposes of this article means a biological, adopted, or foster child, stepchild, legal ward, or a child to whom the employee stands in loco parentis. This definition of a child is applicable regardless of age or dependency status.

(2) A biological, adoptive, or foster parent, stepparent, or legal guardian of an employee or the employee's spouse or registered domestic partner, or a person who stood in loco parentis when the employee was a minor child.

(3) A spouse.

(4) A registered domestic partner.

(5) A grandparent.

(6) A grandchild.

(7) A sibling.

(8) A designated person, which, for purposes of this article, means a person identified by the employee at the time the employee requests paid sick days. An employer may limit an employee to one designated person per 12-month period for paid sick days.

(d) "Health care provider" has the same meaning as defined in Section 12945.2 of the Government Code.

(e) "Paid sick days" means time that is compensated at the same wage as the employee normally earns during regular work hours and is provided by an employer to an employee for the purposes described in Section 246.5.

SEC. 2. Section 246 of the Labor Code is amended to read:

246. (a) (1) An employee who, on or after July 1, 2015, works in California for the same employer for 30 or more days within a year from the commencement of employment is entitled to paid sick days as specified in this section. For an individual provider of waiver personal care services under Section 14132.97 of the Welfare and Institutions Code who also provides in-home supportive services in an applicable month, eligibility shall be determined based on the aggregate number of monthly hours worked between in-home supportive services and waiver personal care services pursuant to subdivision (d) of Section 14132.971.

(2) On and after July 1, 2018, a provider of in-home supportive services under Section 14132.95, 14132.952, or 14132.956 of, or Article 7 (commencing with Section 12300) of Chapter 3 of Part 3 of Division 9 of, the Welfare and Institutions Code, who works in California for 30 or more days within a year from the commencement of employment is entitled to paid sick days as specified in subdivision (e) and subject to the rate of accrual in paragraph (1) of subdivision (b). For an individual provider of waiver personal care services under Section 14132.97 of the Welfare and Institutions Code, entitlement to paid sick days begins on July 1, 2019.

(b) (1) An employee shall accrue paid sick days at the rate of not less than one hour per every 30 hours worked, beginning at the commencement of employment or the operative date of this article, whichever is later, subject to the use and accrual limitations set forth in this section.

(2) An employee who is exempt from overtime requirements as an administrative, executive, or professional employee under a wage order of the Industrial Welfare Commission is deemed to work 40 hours per workweek for the purposes of this section, unless the employee's normal workweek is less than 40 hours, in which case the employee shall accrue paid sick days based upon that normal workweek.

(3) An employer may use a different accrual method, other than providing one hour per every 30 hours worked, provided that the accrual is on a regular basis so that an employee has no less than 24 hours of accrued sick leave or paid time off by the 120th calendar day of employment or each calendar year, or in each 12-month period, and no less than 40 hours of accrued sick leave or paid time off by the 200th calendar day of employment or each calendar year, or in each 12-month period.

(4) An employer may satisfy the accrual requirements of this section by providing not less than 24 hours or 3 days of paid sick leave that is available to the employee to use by the completion of the employee's 120th calendar day of employment, and no less than 40 hours or 5 days of paid sick leave that is available to the employee to use by the completion of the employee's 200th calendar day of employment.

(c) An employee shall be entitled to use accrued paid sick days beginning on the 90th day of employment, after which day the employee may use paid sick days as they are accrued.

(d) Accrued paid sick days shall carry over to the following year of employment. However, an employer may limit an employee's use of accrued paid sick days to 40 hours or five days in each year of employment, calendar year, or 12-month period. This section shall be satisfied and no accrual or carryover is required if the full amount of leave is received at the beginning of each year of employment, calendar year, or 12-month period. The term "full amount of leave" means five days or 40 hours.

(e) For a provider of in-home supportive services under Section 14132.95, 14132.952, or 14132.956 of, or Article 7 (commencing with Section 12300) of Chapter 3 of Part 3 of Division 9 of, and an individual provider of waiver personal care services under Section 14132.97 of, the Welfare and Institutions Code, the term “full amount of leave” is defined as follows:

(1) Eight hours or one day in each year of employment, calendar year, or 12-month period beginning July 1, 2018.

(2) Sixteen hours or two days in each year of employment, calendar year, or 12-month period beginning when the minimum wage, as set forth in paragraph (1) of subdivision (b) of Section 1182.12 and accounting for any years postponed under subparagraph (D) of paragraph (3) of subdivision (d) of Section 1182.12, has reached thirteen dollars (\$13) per hour.

(3) Twenty-four hours or three days in each year of employment, calendar year, or 12-month period beginning when the minimum wage, as set forth in paragraph (1) of subdivision (b) of Section 1182.12 and accounting for any years postponed under subparagraph (D) of paragraph (3) of subdivision (d) of Section 1182.12, has reached fifteen dollars (\$15) per hour.

(4) Forty hours or five days in each year of employment, calendar year, or 12-month period beginning January 1, 2024.

(f) An employer is not required to provide additional paid sick days pursuant to this section if the employer has a paid leave policy or paid time off policy, the employer makes available an amount of leave applicable to employees that may be used for the same purposes and under the same conditions as specified in this section, and the policy satisfies one of the following:

(1) Satisfies the accrual, carryover, and use requirements of this section.

(2) Provided paid sick leave or paid time off to a class of employees before January 1, 2015, pursuant to a sick leave policy or paid time off policy that used an accrual method different than providing one hour per 30 hours worked, provided that the accrual is on a regular basis so that an employee, including an employee hired into that class after January 1, 2015, has no less than one day or eight hours of accrued sick leave or paid time off within three months of employment of each calendar year, or each 12-month period, and the employee was eligible to earn at least five days or 40 hours of sick leave or paid time off within six months of employment. If an employer modifies the accrual method used in the policy it had in place prior to January 1, 2015, the employer shall comply with any accrual method set forth in subdivision (b) or provide the full amount of leave at the beginning of each year of employment, calendar year, or 12-month period. This section does not prohibit the employer from increasing the accrual amount or rate for a class of employees covered by this subdivision.

(3) Notwithstanding any other law, sick leave benefits provided pursuant to the provisions of Sections 19859 to 19868.3, inclusive, of the Government Code, or annual leave benefits provided pursuant to the provisions of Sections 19858.3 to 19858.7, inclusive, of the Government Code, or by provisions of a memorandum of understanding reached pursuant to Section 3517.5 that incorporate or supersede provisions of Section 19859 to 19868.3, inclusive, or Sections 19858.3 to 19858.7, inclusive, of the Government Code, meet the requirements of this section.

(g) (1) Except as specified in paragraph (2), an employer is not required to provide compensation to an employee for accrued, unused paid sick days upon termination, resignation, retirement, or other separation from employment.

(2) If an employee separates from an employer and is rehired by the employer within one year from the date of separation, previously accrued and unused paid sick days shall be reinstated. The employee shall be entitled to use those previously accrued and unused paid sick days and to accrue additional paid sick days upon rehiring, subject to the use and accrual limitations set forth in this section. An employer is not

required to reinstate accrued paid time off to an employee that was paid out at the time of termination, resignation, or separation of employment.

(h) An employer may lend paid sick days to an employee in advance of accrual, at the employer's discretion and with proper documentation.

(i) An employer shall provide an employee with written notice that sets forth the amount of paid sick leave available, or paid time off leave an employer provides in lieu of sick leave, for use on either the employee's itemized wage statement described in Section 226 or in a separate writing provided on the designated pay date with the employee's payment of wages. If an employer provides unlimited paid sick leave or unlimited paid time off to an employee, the employer may satisfy this section by indicating on the notice or the employee's itemized wage statement "unlimited." The penalties described in this article for a violation of this subdivision shall be in lieu of the penalties for a violation of Section 226. This subdivision shall apply to employers covered by Wage Order 11 or 12 of the Industrial Welfare Commission only on and after January 21, 2016.

(j) An employer has no obligation under this section to allow an employee's total accrual of paid sick leave to exceed 80 hours or 10 days, provided that an employee's rights to accrue and use paid sick leave are not limited other than as allowed under this section.

(k) An employee may determine how much paid sick leave they need to use, provided that an employer may set a reasonable minimum increment, not to exceed two hours, for the use of paid sick leave.

(l) For the purposes of this section, an employer shall calculate paid sick leave using any of the following calculations:

(1) Paid sick time for nonexempt employees shall be calculated in the same manner as the regular rate of pay for the workweek in which the employee uses paid sick time, whether or not the employee actually works overtime in that workweek.

(2) Paid sick time for nonexempt employees shall be calculated by dividing the employee's total wages, not including overtime premium pay, by the employee's total hours worked in the full pay periods of the prior 90 days of employment.

(3) Paid sick time for exempt employees shall be calculated in the same manner as the employer calculates wages for other forms of paid leave time.

(m) If the need for paid sick leave is foreseeable, the employee shall provide reasonable advance notification. If the need for paid sick leave is unforeseeable, the employee shall provide notice of the need for the leave as soon as practicable.

(n) An employer shall provide payment for sick leave taken by an employee no later than the payday for the next regular payroll period after the sick leave was taken.

(o) The State Department of Social Services, in consultation with stakeholders, shall convene a workgroup to implement paid sick leave for in-home supportive services providers as specified in this section. This workgroup shall finish its implementation work by November 1, 2017, and the State Department of Social Services shall issue guidance such as an all-county letter or similar instructions by December 1, 2017.

(p) No later than February 1, 2019, the State Department of Social Services, in consultation with the Department of Finance and stakeholders, shall reconvene the paid sick leave workgroup for in-home supportive services providers. The workgroup shall discuss how paid sick leave affects the provision of in-home supportive services. The workgroup shall consider the potential need for a process to cover an in-home supportive services recipient's authorized hours when a provider needs to utilize their sick time. This workgroup shall finish its work by November 1, 2019.

(q) Notwithstanding the rulemaking provisions of the Administrative Procedure Act (Chapter 3.5 (commencing with Section 11340) of Part 1 of Division 3 of Title 2 of the Government Code), the State Department of Social Services may implement, interpret, or make specific this section by means of an all-county letter, or similar instructions, without taking any regulatory action.

(r) Subdivisions (g), (h), (i), (l), (m), and (n) shall preempt any local ordinance to the contrary.

SEC. 3. Section 246.5 of the Labor Code is amended to read:

246.5. (a) Upon the oral or written request of an employee, an employer shall provide paid sick days for the following purposes:

(1) Diagnosis, care, or treatment of an existing health condition of, or preventive care for, an employee or an employee's family member.

(2) For an employee who is a victim of domestic violence, sexual assault, or stalking, the purposes described in subdivision (c) of Section 230 and subdivision (a) of Section 230.1.

(b) An employer shall not require as a condition of using paid sick days that the employee search for or find a replacement worker to cover the days during which the employee uses paid sick days.

(c) (1) An employer shall not deny an employee the right to use accrued sick days, discharge, threaten to discharge, demote, suspend, or in any manner discriminate against an employee for using accrued sick days, attempting to exercise the right to use accrued sick days, filing a complaint with the department or alleging a violation of this article, cooperating in an investigation or prosecution of an alleged violation of this article, or opposing any policy or practice or act that is prohibited by this article.

(2) There shall be a rebuttable presumption of unlawful retaliation if an employer denies an employee the right to use accrued sick days, discharges, threatens to discharge, demotes, suspends, or in any manner discriminates against an employee within 30 days of any of the following:

(A) The filing of a complaint by the employee with the Labor Commissioner or alleging a violation of this article.

(B) The cooperation of an employee with an investigation or prosecution of an alleged violation of this article.

(C) Opposition by the employee to a policy, practice, or act that is prohibited by this article.

(d) Notwithstanding subdivision (a) of Section 245.5, for purposes of this section, "employee" shall include an employee described in paragraph (1) of subdivision (a) of Section 245.5.

SEC. 4. The Legislature finds and declares that establishing uniform statewide regulation of certain aspects of paid sick leave is a matter of statewide concern and is not a municipal affair as that term is used in Section 5 of Article XI of the California Constitution. Therefore, Sections 1, 2, and 3 of this act amending Sections 245.5, 246, and 246.5 of the Labor Code apply to all cities, including charter cities.

1. Full Time Employees Sick Leave Accrual

Every regular full-time employee shall accrue sick leave at the rate of 3.69 hours per pay period. Employees in regular positions budgeted less than eighty (80) hours per pay period shall receive sick leave accumulation on a pro-rata basis.

Paid sick leave shall continue to accrue during any period of leave with pay, including sick leave. Leave will accrue at a prorated rate if any part of the leave becomes unpaid. There shall be no cap on the number of sick leave hours an employee may accumulate for illness.

2. Part-Time Year-Round Employees

Employees in this classification will receive ~~twenty-four (24)~~forty (40) hours of sick leave upon ~~completion of six pay periods (84 calendar days)~~date of hire. Beginning the seventh pay period employees will accrue sick leave at 2.76 hours per pay period.

Paid sick leave shall continue to accrue during any period of leave with pay, including sick leave. Leave will accrue at a prorated rate if any part of the leave becomes unpaid. There shall be no cap on the number of sick leave hours an employee may accumulate for illness.

3. Temporary or Seasonal and/or Part Time Restricted Employees

Temporary or Seasonal Employees shall receive ~~twenty-four (24)~~forty (40) hours of sick leave upon ~~completion of six pay periods (84 calendar days)~~date of hire. Beginning their second year of employment the employee will receive an additional ~~twenty-four (24)~~forty (40) hours, not to exceed ~~forty-eight (48)~~eighty (80) hours.

1. Full Time Employees Sick Leave Accrual

Every regular full-time employee shall accrue sick leave at the rate of 3.69 hours per pay period. Employees in regular positions budgeted less than eighty (80) hours per pay period shall receive sick leave accumulation on a pro-rata basis.

Paid sick leave shall continue to accrue during any period of leave with pay, including sick leave. Leave will accrue at a prorated rate if any part of the leave becomes unpaid. There shall be no cap on the number of sick leave hours an employee may accumulate for illness.

2. Part-Time Year-Round Employees\

Employees in this classification will receive forty (40) hours of sick leave upon date of hire. Beginning the seventh pay period employees will accrue sick leave at 2.76 hours per pay period.

Paid sick leave shall continue to accrue during any period of leave with pay, including sick leave. Leave will accrue at a prorated rate if any part of the leave becomes unpaid. There shall be no cap on the number of sick leave hours an employee may accumulate for illness.

3. Temporary or Seasonal and/or Part Time Restricted Employees

Temporary or Seasonal Employees shall receive forty (40) hours of sick leave upon date of hire. Beginning their second year of employment the employee will receive an additional forty (40) hours, not to exceed eighty (80) hours.

ARTICLE 24 — SICK LEAVE

A. Accrual of Sick Leave: Every regular full-time employee shall accrue sick leave at the rate of 3.69 hours per pay period. Employees in regular positions budgeted less than eighty (80) hours per pay period shall receive sick leave accumulation on a pro-rata basis. Part-time year-round employees shall accrue **forty (40) hours upon date of hire. Beginning the seventh (7th) pay period employees will accrue** sick leave at 2.76 hours per pay period.

1. Paid sick leave shall continue to accrue during any period of leave with pay, including sick leave. There shall be no cap on the number of sick leave hours an employee may accumulate for illness.

2. Temporary or Seasonal Employees shall be entitled to paid sick leave. Sick leave for eligible Temporary or Seasonal Employees shall ~~accrue at the rate of one (1) hour for every thirty (30) hours worked and 31 accrual of sick leave shall be capped at six (6) days or forty-eight (48) hours. Sick leave may be used after thirty (30) days of employment~~ receive forty (40) hours of sick leave upon date of hire. Beginning their second year of employment the employee will receive an additional forty (40) hours, not to exceed eighty hours.:-

ARTICLE 24 — SICK LEAVE

A. Accrual of Sick Leave: Every regular full-time employee shall accrue sick leave at the rate of 3.69 hours per pay period. Employees in regular positions budgeted less than eighty (80) hours per pay period shall receive sick leave accumulation on a pro-rata basis. Part-time year-round employees shall accrue forty (40) hours upon date of hire. Beginning the seventh (7th) pay period employees will accrue sick leave at 2.76 hours per pay period.

1. Paid sick leave shall continue to accrue during any period of leave with pay, including sick leave. There shall be no cap on the number of sick leave hours an employee may accumulate for illness.

2. Temporary or Seasonal Employees shall be entitled to paid sick leave. Sick leave for eligible Temporary or Seasonal Employees shall receive forty (40) hours of sick leave upon date of hire. Beginning their second year of employment the employee will receive an additional forty (40) hours, not to exceed eighty hours.

RESOLUTION NO. 761

A RESOLUTION OF THE BOARD OF DIRECTORS FOR THE PLEASANT VALLEY RECREATION & PARK DISTRICT, CALIFORNIA EXPANDING THE PAID SICK LEAVE POLICY IN THE 2022 PERSONNEL POLICY MANUAL

WHEREAS, on October 5, 2022, the District Board of Directors approved the Personnel Policy Manual; and

WHEREAS, the intent of the Personnel Policy Manual is to provide clarification to employees and management of the current personnel procedures, and

WHEREAS, the State of California adopted Assembly Bill 616 on January 1, 2024 entitling employees to a minimum of five days or twenty-four hours of sick leave; and

WHEREAS, District staff recommends that the Board of Directors adopt the proposed draft enhanced Sick Leave Policy to the Personnel Policy Manual attached hereto as Exhibit A.

NOW, THEREFORE, THE PLEASANT VALLEY RECREATION & PARK DISTRICT, BOARD OF DIRECTORS, CALIFORNIA DOES HEREBY RESOLVE AS FOLLOWS:

Section 1. The recitals above are true and correct and incorporated herein by this reference.

Section 2. The Board of Directors hereby adopts the following enhanced Sick Leave Policy, attached in full hereto as Exhibit A. The Sick Leave Policy attached hereto as Exhibit A shall supersede and enhance the previous Personnel Policy and MOU.

Section 3. This resolution shall be effective as of the date of its adoption.

PASSED, APPROVED AND ADOPTED this 1st day of May, 2024.

AYES: _____

NOES: _____

ABSENT: _____

ABSTAIN: _____

Mark Malloy, Chair, Board of Directors
PLEASANT VALLEY RECREATION
AND PARK DISTRICT

ATTEST:

Jordan Roberts, Secretary, Board of Directors
PLEASANT VALLEY RECREATION AND PARK DISTRICT

EXHIBIT A

1. Full Time Employees Sick Leave Accrual

Every regular full-time employee shall accrue sick leave at the rate of 3.69 hours per pay period. Employees in regular positions budgeted less than eighty (80) hours per pay period shall receive sick leave accumulation on a pro-rata basis.

Paid sick leave shall continue to accrue during any period of leave with pay, including sick leave. Leave will accrue at a prorated rate if any part of the leave becomes unpaid. There shall be no cap on the number of sick leave hours an employee may accumulate for illness.

2. Part-Time Year-Round Employees\

Employees in this classification will receive forty (40) hours of sick leave upon date of hire. Beginning the seventh pay period employees will accrue sick leave at 2.76 hours per pay period.

Paid sick leave shall continue to accrue during any period of leave with pay, including sick leave. Leave will accrue at a prorated rate if any part of the leave becomes unpaid. There shall be no cap on the number of sick leave hours an employee may accumulate for illness.

3. Temporary or Seasonal and/or Part Time Restricted Employees

Temporary or Seasonal Employees shall receive forty (40) hours of sick leave upon date of hire. Beginning their second year of employment the employee will receive an additional forty (40) hours, not to exceed eighty (80) hours.

ARTICLE 24 — SICK LEAVE

A. Accrual of Sick Leave: Every regular full-time employee shall accrue sick leave at the rate of 3.69 hours per pay period. Employees in regular positions budgeted less than eighty (80) hours per pay period shall receive sick leave accumulation on a pro-rata basis. Part-time year-round employees shall accrue forty (40) hours upon date of hire. Beginning the seventh (7th) pay period employees will accrue sick leave at 2.76 hours per pay period.

1. Paid sick leave shall continue to accrue during any period of leave with pay, including sick leave. There shall be no cap on the number of sick leave hours an employee may accumulate for illness.

2. Temporary or Seasonal Employees shall be entitled to paid sick leave. Sick leave for eligible Temporary or Seasonal Employees shall receive forty (40) hours of sick leave upon date of hire. Beginning their second year of employment the employee will receive an additional forty (40) hours, not to exceed eighty hours.

**PLEASANT VALLEY RECREATION AND PARK DISTRICT
STAFF REPORT / AGENDA REPORT**

TO: BOARD OF DIRECTORS

FROM: MARY OTTEN, GENERAL MANAGER
By: Kathryn Drewry, Human Resources Specialist

DATE: May 1, 2024

**SUBJECT: CONSIDERATION AND ADOPTION OF RESOLUTION
NO. 762, ADDING REPRODUCTIVE LOSS LEAVE TO
THE FAMILY CARE AND MEDICAL LEAVE POLICY
IN THE 2022 PERSONNEL POLICY MANUAL**

BACKGROUND

Senate Bill 848, which became effective on January 1, 2024, entitles employees to five (5) days of leave following a reproductive loss event. SB 8448 adds section 12945.6 to the Government Code and requires employers to provide reproductive loss leave to eligible employees under specified circumstances:

1. Any person who employs (5) or more persons to perform services for a wage or salary; and
2. The state and any political or civil subdivision of the state, including but not limited to cities, and counties.

An employee is eligible for reproductive loss leave after at least 30 days of employment. An eligible employee is entitled to take up to five days of reproductive loss leave (which may be taken nonconsecutively but shall be completed within three months) per reproductive loss event, up to a total amount of 20 days of reproductive loss leave within a 12-month period.

ANALYSIS

SB 848 defines a reproductive loss as “the day or, for a multiple-day event, the final day of a failed adoption, failed surrogacy, miscarriage, stillbirth, or an unsuccessful assisted reproduction” (i.e., an unsuccessful round of intrauterine insemination or of an assisted reproductive technology procedure).

Employees under the following circumstances related to a reproductive loss event are eligible for reproductive loss leave:

- A failed adoption event applies to an employee who would have been a parent of the adoptee if the adoption had been completed.
- A failed surrogacy event applies to an employee who would have been a parent of a child born as a result of the surrogacy.
- A miscarriage event applies to an employee who experienced miscarriage, who is the current spouse or domestic partner of a person who experienced a miscarriage, or who

would have been a parent of a child born as a result of a pregnancy that resulted in miscarriage.

- A stillbirth event applies to an employee whose pregnancy resulted in a stillbirth, who is the current spouse or domestic partner of a person whose pregnancy resulted in a stillbirth, or who would have been a parent of a child born as a result of a pregnancy that resulted in stillbirth.
- An unsuccessful assisted reproduction event applies to an employee who experienced such event, who is the current spouse or domestic partner of a person who experienced such event, or who would have been a parent of a child born as a result of a pregnancy had the assisted reproduction been successful.

Reproductive loss leave may be taken pursuant to any existing applicable leave. An employee may use vacation, management, compensatory time, or available sick leave, that may be available to the employee.

Under SB 848, it is an unlawful employment practice for an employer to refuse to grant a request from an eligible employee to take reproductive loss leave, or for an employer to retaliate against an eligible employee because the employee exercised the right to reproductive loss leave or gave information or testimony as to reproductive loss leave. It is also an unlawful employment practice for an employer to interfere with, restrain, deny the exercise of, or deny the attempt to exercise the rights afforded to employees under the reproductive loss leave law.

FISCAL IMPACT

There is no fiscal impact at this time.

RECOMMENDATION

It is recommended the Board of Directors approve Resolution No. 762, adding Reproductive Loss Leave to the Family Care and Medical Leave Policy in the 2022 Personnel Policy Manual.

ATTACHMENTS

- 1) Senate Bill 848 (3 pages)
- 2) Unrepresented Employee Manual Article 5 - Leave of Absence (1 page)
- 3) Resolution 762 (3 pages)

Senate Bill No. 848

CHAPTER 724

An act to add Section 12945.6 to the Government Code, relating to employment.

[Approved by Governor October 10, 2023. Filed with Secretary of State October 10, 2023.]

LEGISLATIVE COUNSEL'S DIGEST

SB 848, Rubio. Employment: leave for reproductive loss.

Existing law, the California Fair Employment and Housing Act, makes it an unlawful employment practice for an employer to refuse to grant a request by any employee to take up to 5 days of bereavement leave upon the death of a family member.

This bill would additionally make it an unlawful employment practice for an employer to refuse to grant a request by an eligible employee to take up to 5 days of reproductive loss leave following a reproductive loss event, as defined. The bill would require that leave be taken within 3 months of the event, except as described, and pursuant to any existing leave policy of the employer. The bill would provide that if an employee experiences more than one reproductive loss event within a 12-month period, the employer is not obligated to grant a total amount of reproductive loss leave time in excess of 20 days within a 12-month period. Under the bill, in the absence of an existing policy, the reproductive loss leave may be unpaid. However, the bill would authorize an employee to use certain other leave balances otherwise available to the employee, including accrued and available paid sick leave. The bill would make leave under these provisions a separate and distinct right from any right under the California Fair Employment and Housing Act.

The bill would make it an unlawful employment practice for an employer to retaliate against an individual, as described, because of the individual's exercise of the right to reproductive loss leave or the individual's giving of information or testimony as to reproductive loss leave, as described. The bill would require the employer to maintain employee confidentiality relating to reproductive loss leave, as specified.

Existing constitutional provisions require that a statute that limits the right of access to the meetings of public bodies or the writings of public officials and agencies be adopted with findings demonstrating the interest protected by the limitation and the need for protecting that interest.

This bill would make legislative findings to that effect.

DIGEST KEY

Vote: majority Appropriation: no Fiscal Committee: yes Local Program: no

BILL TEXT

THE PEOPLE OF THE STATE OF CALIFORNIA DO ENACT AS FOLLOWS:

SECTION 1. Section 12945.6 is added to the Government Code, to read:

12945.6. (a) For purposes of this section, the following definitions apply:

(1) (A) "Assisted reproduction" means a method of achieving a pregnancy through an artificial insemination or an embryo transfer and includes gamete and embryo donation.

(B) "Assisted reproduction" does not include any pregnancy achieved through sexual intercourse.

(2) "Employee" means a person employed by the employer for at least 30 days prior to the commencement of the leave.

(3) "Employer" means either of the following:

(A) A person who employs five or more persons to perform services for a wage or salary.

(B) The state and any political or civil subdivision of the state, including, but not limited to, cities and counties.

(4) "Failed adoption" means the dissolution or breach of an adoption agreement with the birth mother or legal guardian, or an adoption that is not finalized because it is contested by another party. This event applies to a person who would have been a parent of the adoptee if the adoption had been completed.

(5) "Failed surrogacy" means the dissolution or breach of a surrogacy agreement, or a failed embryo transfer to the surrogate. This event applies to a person who would have been a parent of a child born as a result of the surrogacy.

(6) "Miscarriage" means a miscarriage by a person, by the person's current spouse or domestic partner, or by another individual if the person would have been a parent of a child born as a result of the pregnancy.

(7) "Reproductive loss event" means the day or, for a multiple-day event, the final day of a failed adoption, failed surrogacy, miscarriage, stillbirth, or an unsuccessful assisted reproduction.

(8) "Reproductive loss leave" means the leave provided by subdivision (b).

(9) "Stillbirth" means a stillbirth resulting from a person's pregnancy, the pregnancy of a person's current spouse or domestic partner, or another individual, if the person would have been a parent of a child born as a result of the pregnancy that ended in stillbirth.

(10) "Unsuccessful assisted reproduction" means an unsuccessful round of intrauterine insemination or of an assisted reproductive technology procedure. This event applies to a person, the person's current spouse or domestic partner, or another individual, if the person would have been a parent of a child born as a result of the pregnancy.

(b) (1) It shall be an unlawful employment practice for an employer to refuse to grant a request by any employee to take up to five days of reproductive loss leave following a reproductive loss event. If an employee experiences more than one reproductive loss event within a 12-month period, an employer shall not be obligated to grant a total amount of reproductive loss leave time in excess of 20 days within a 12-month period.

(2) The employer shall allow the days an employee takes for reproductive loss leave to be nonconsecutive.

(3) (A) Except as provided in subparagraph (B), reproductive loss leave shall be completed within three months of the event entitling the employee to that leave under paragraph (1).

(B) Notwithstanding subparagraph (A), if, prior to or immediately following a reproductive loss event, an employee is on or chooses to go on leave from work pursuant to Section 12945, 12945.2, or any other

leave entitlement under state or federal law, the employee shall complete their reproductive loss leave within three months of the end date of the other leave.

(4) (A) Reproductive loss leave shall be taken pursuant to any existing applicable leave policy of the employer.

(B) If there is no existing applicable leave policy, reproductive loss leave may be unpaid, except that an employee may use vacation, personal leave, accrued and available sick leave, or compensatory time off that is otherwise available to the employee.

(c) It shall be an unlawful employment practice for an employer to retaliate against an individual, including, but not limited to, refusing to hire, discharging, demoting, fining, suspending, expelling, or discriminating against, an individual because of either of the following:

(1) An individual's exercise of the right to reproductive loss leave.

(2) An individual's giving information or testimony as to their own reproductive loss leave, or another person's reproductive loss leave, in an inquiry or proceeding related to rights guaranteed under this section.

(d) It shall be an unlawful employment practice for an employer to interfere with, restrain, or deny the exercise of, or the attempt to exercise, any right provided under this section.

(e) The employer shall maintain the confidentiality of any employee requesting leave under this section. Any information provided to the employer pursuant to this section shall be maintained as confidential and shall not be disclosed except to internal personnel or counsel, as necessary, or as required by law.

(f) An employee's right to reproductive loss leave shall be construed as a separate and distinct right from any right under this part.

SEC. 2. The Legislature finds and declares that Section 1 of this act, which adds Section 12945.6 to the Government Code, imposes a limitation on the public's right of access to the meetings of public bodies or the writings of public officials and agencies within the meaning of Section 3 of Article I of the California Constitution. Pursuant to that constitutional provision, the Legislature makes the following findings to demonstrate the interest protected by this limitation and the need for protecting that interest:

The confidentiality provisions set forth in Section 1 further the need to protect the privacy rights of employees regarding a reproductive loss, and to protect the enforcement process related to violations of these provisions. These limitations are needed in order to strike the proper balance between the privacy interests of the employee and the employee's family, and the public's right to access.

ARTICLE 5 – LEAVE OF ABSENCE

Reproductive Loss Leave

An employee is eligible for reproductive loss leave after at least 30 days of employment. An eligible employee is entitled to take up to five days of reproductive loss leave (which may be taken nonconsecutively) per reproductive loss event, up to a total amount of 20 days of reproductive loss leave within a 12-month period.

Employees under the following circumstances related to a reproductive loss event are eligible for reproductive loss leave:

- A failed adoption event applies to an employee who would have been a parent of the adoptee if the adoption had been completed.
- A failed surrogacy event applies to an employee who would have been a parent of child born as a result of the surrogacy.
- A miscarriage event applies to an employee who experienced miscarriage, who is the current spouse or domestic partner of a person who experienced a miscarriage, or who would have been a parent of a child born as a result of a pregnancy that resulted in miscarriage.
- A stillbirth event applies to an employee whose pregnancy resulted in a stillbirth, who is the current spouse or domestic partner of a person whose pregnancy resulted in a stillbirth, or who would have been a parent of a child born as a result of a pregnancy that resulted in stillbirth.
- An unsuccessful assisted reproduction event applies to an employee who experienced such event, who is the current spouse or domestic partner of a person who experienced such event, or who would have been a parent of a child born as a result of a pregnancy had the assisted reproduction been successful.

Reproductive loss leave may be taken pursuant to any existing applicable leave. An employee may use vacation, management, compensatory time, or available sick leave, that may be available to the employee.

RESOLUTION NO. 762

A RESOLUTION OF THE BOARD OF DIRECTORS FOR THE PLEASANT VALLEY RECREATION & PARK DISTRICT, CALIFORNIA ADDING REPRODUCTIVE LOSS LEAVE TO THE FAMILY CARE AND MEDICAL LEAVE POLICY IN THE 2022 PERSONNEL POLICY MANUAL

WHEREAS, on October 5, 2022, the District Board of Directors approved the Personnel Policy Manual; and

WHEREAS, the intent of the Personnel Policy Manual is to provide clarification to employees and management of the current personnel procedures, and

WHEREAS, the State of California adopted Assembly Bill 848 on January 1, 2024 allowing five days of leave following a reproductive loss event.

WHEREAS, District staff recommends that the Board of Directors adopt the proposed draft Reproductive Loss Leave to Section E of the Personnel Policy Manual attached hereto as Exhibit A.

NOW, THEREFORE, THE PLEASANT VALLEY RECREATION & PARK DISTRICT, BOARD OF DIRECTORS, CALIFORNIA DOES HEREBY RESOLVE AS FOLLOWS:

Section 1. The recitals above are true and correct and incorporated herein by this reference.

Section 2. The Board of Directors hereby adopts the following Reproductive Loss Leave, attached in full hereto as Exhibit A. The Reproductive Loss Leave attached hereto as Exhibit A shall add to the previous Section E of the Personnel Policy.

Section 3. This resolution shall be retroactive effective to January 1, 2024.

PASSED, APPROVED AND ADOPTED this 1st day of May, 2024.

AYES: _____

NOES: _____

ABSENT: _____

ABSTAIN: _____

Mark Malloy, Chair, Board of Directors
PLEASANT VALLEY RECREATION
AND PARK DISTRICT

ATTEST:

Jordan Roberts, Secretary, Board of Directors
PLEASANT VALLEY RECREATION AND PARK DISTRICT

EXHIBIT A

ARTICLE 5 – LEAVE OF ABSENCE

Reproductive Loss Leave

An employee is eligible for reproductive loss leave after at least 30 days of employment. An eligible employee is entitled to take up to five days of reproductive loss leave (which may be taken nonconsecutively) per reproductive loss event, up to a total amount of 20 days of reproductive loss leave within a 12-month period.

Employees under the following circumstances related to a reproductive loss event are eligible for reproductive loss leave:

- A failed adoption event applies to an employee who would have been a parent of the adoptee if the adoption had been completed.
- A failed surrogacy event applies to an employee who would have been a parent of child born as a result of the surrogacy.
- A miscarriage event applies to an employee who experienced miscarriage, who is the current spouse or domestic partner of a person who experienced a miscarriage, or who would have been a parent of a child born as a result of a pregnancy that resulted in miscarriage.
- A stillbirth event applies to an employee whose pregnancy resulted in a stillbirth, who is the current spouse or domestic partner of a person whose pregnancy resulted in a stillbirth, or who would have been a parent of a child born as a result of a pregnancy that resulted in stillbirth.
- An unsuccessful assisted reproduction event applies to an employee who experienced such event, who is the current spouse or domestic partner of a person who experienced such event, or who would have been a parent of a child born as a result of a pregnancy had the assisted reproduction been successful.

Reproductive loss leave may be taken pursuant to any existing applicable leave. An employee may use vacation, management, compensatory time, or available sick leave, that may be available to the employee.

**PLEASANT VALLEY RECREATION AND PARK DISTRICT
STAFF REPORT / AGENDA REPORT**

TO: BOARD OF DIRECTORS

FROM: MARY OTTEN, GENERAL MANAGER
By: Nick Marienthal, Park Supervisor

DATE: May 1, 2024

**SUBJECT: CONSIDERATION AND APPROVAL TO EXTEND THE
TREE TRIMMING CONTRACT BETWEEN THE
DISTRICT AND WEST COAST ARBORIST FOR A TERM
OF ONE YEAR**

SUMMARY

The District currently has 3,345 trees inventoried with an estimated value of \$16,917,340. Due to a lack of necessary equipment and staffing, the District began using third-party tree maintenance contractors in 2008 to help offset some of the District's bigger tree-trimming jobs. In 2017, the District entered into a five-year agreement with West Coast Arborist (WCA) to inventory all of the District's trees and set a starting point for grid pruning all District parks with the option to extend for three one-year terms. The first additional one-year term was Board approved on June 1, 2022 and the second one-year term was approved on June 7, 2023.

BACKGROUND

Since the District entered into an agreement with WCA in 2017, the following has been completed:

- Complete inventory of all 28 parks - 3,345 Trees
- 627 trees have been fully pruned
- 25 parks have been grid pruned - 2,772 Trees
- 147 new trees planted
- Charter Oak windrow:
 - 100 Eucalyptus trees removed
 - 188 Eucalyptus trees pruned
 - 65 new trees planted

It is important for the District to manage and maintain the overall health and preservation of its urban forest. When the contract first started, the District was on an 8–10-year grid pruning cycle. With increases to the budget, the District is now on a 7–8-year cycle and is working towards the goal of a 4-year cycle, where all the parks will be on a 4-year rotation for pruning. Charter Oak windrow Eucalyptus removals will be completed in approximately 7-10 years which will allow staff to allocate that portion of the budget to grid pruning, full pruning, planting new trees, and emergencies. The approach of grid pruning reduces both the potential of tree failure and the District's liability in addition to creating good tree structure and shape.

ANALYSIS

Over the course of the contract, Staff has worked well with WCA to successfully implement the grid pruning cycle set by each Fiscal Year budget. WCA crews work diligently and safely to complete each work order. In the current contract there is the option for up to three (3) one-year extensions. This would be the third and final extension to the contract, if approved.

The scope of service will remain the same where the contractor will be responsible for maintaining a web-based software, Arbor Access and updating it with any work they perform such as grid pruning, palm tree pruning, tree removal, stump grinding, and full pruning which are all included in the current contract. District staff will still be responsible for inputting all in-house tree trimming, removals, stump grinding, and tree planting into Arbor Access. All work performed by WCA will be performed in accordance with the International Society of Arboriculture.

Staff have been in verbal discussions regarding a contract extension and negotiating a service rate. WCA has proposed a 5% increase for the grid pruning and a 3% increase for all other services to extend the contract by one year. Should the Board approve the extension, District staff will continue to allocate budgetary items for grid pruning, emergency services, and windrow tree care at Charter Oaks.

ALTERNATIVE OPTIONS:

If the Board chooses not to take the recommended action on this item, the alternative actions available are:

- Allow the current contract, set to expire on July 1, 2024, to lapse and instruct District staff to handle all tree care within the District. This approach would necessitate the District's investment in equipment and additional staffing.
- Allow the current contract to expire on July 1, 2024, and initiate a Request for Proposal (RFP) for contractual tree services.

FISCAL IMPACT

This action has no adverse financial implications. The funding for the extension and the proposed increases are allocated in the FY 2024/2025 budget under line-item No. 6719 for Tree Care.

RECOMMENDATION

It is recommended that the Board of Directors approve the one-year extension from July 1, 2024 through June 30, 2025, for the tree trimming contract between the District and West Coast Arborist.

ATTACHMENTS

- 1) West Coast Arborist Agreement (14 pages)
- 2) Third Amendment to the Agreement (2 pages)
- 3) Current Price Sheet "Exhibit B" (1 page)
- 4) 5% & 3% Proposed Itemized Price Sheet "Exhibit B-1" (1 page)

CONTRACT FOR TREE TRIMMING AND TREE MAINTENANCE SERVICES AS IDENTIFIED IN RFP NO. PVRPD- TS2017

This Contract for Tree Trimming and Tree Maintenance Services (“Contract”) is made and entered into in the County of Ventura, State of California, this July 3, 2017, by and between the Pleasant Valley Recreation and Park District, a special district (“District”), and West Coast Arborist (“Contractor”).

WHEREAS, The District desires to hire Contractor to perform Tree Trimming and Tree maintenance services specified herein; and

WHEREAS, Contractor represents that Contractor and/or Contractor’s personnel have the qualifications and experience to properly perform such services;

NOW, THEREFORE, District and Contractor hereby agree as follows:

1. Scope of Services

Contractor shall furnish District with tree maintenance services at all District owned facilities, as more particularly set forth in Exhibit A attached hereto and incorporated by this reference in full herein.

2. Method of Performing Services

Subject to the terms and conditions of this Contract, Contractor shall perform the services in the method, detail, and means of performing the services as set forth in Exhibits A, the District’s Request for Proposals, and B, Contractor’s Proposal. If there is a conflict in language the contract will prevail.

3. Standard of Performance

- a. All work shall be completed in a competent manner according to standard practices of the industry. All persons engaged in the work, including subcontractors, will be considered employees of the Contractor. The Contractor will be held responsible for their work. The District will deal directly with and make all payments to the Contractor.
- b. Subcontracting of any or all of the work to be done will in no way relieve the Contractor of any part of responsibilities under the contract.
- c. Periods of performance may be extended if the facts as to the cause of delays justify such extension in the opinion of the General Manager.

4. Nonexclusive Services

This Contract shall not be interpreted to prevent or preclude Contractor from rendering any services for Contractor’s own account or to any other person or entity as Contractor in its sole discretion shall determine. Contractor agrees that performing such services will not materially interfere with services to be performed for the District.

5. Coordination of Services

All services are to be coordinated with the Park Service Manager or designee ("Park Supervisor") and shall be performed under the general direction of the General Manager.

6. Place of Work

Contractor shall perform the services provided for in this Contract at all District owned sites.

7. Correction of Errors

Contractor agrees to correct, at its expense, all errors which may be disclosed during review of Contractor's services. Should Contractor fail to make such corrections in a reasonably and timely manner, such corrections shall be made by District, and the cost thereof shall be paid by Contractor.

8. Time for Performance

All services performed under this Contract shall be completed pursuant to the schedule provided in Exhibit A (Tree Trimming and Tree Maintenance services Proposal) attached hereto and incorporated by this reference in full herein.

9. Principal in Charge

Contractor hereby designates **Mr. Patrick Mahoney** as its principal-in-charge and person responsible for necessary coordination with Park Service Manager or designee.

10. Permits, Licenses, Certificates

Contractor, at Contractor's sole expense, shall obtain and maintain during the term of this Contract, all City, State and Federal permits, licenses, and certificates required in connection with the performance of services under this Contract, including a City of Camarillo business license.

Contractor shall be required to possess a State of California C-27 Landscape Contractor's license and a C-19/D49 (Limited Specialty/Tree Service). Also; a California Department of Pesticide Regulation pesticide applicators/operators certificate in the appropriate categories prior to signing a written agreement with the District.

11. District's Responsibility

District shall cooperate with Contractor as may be reasonably necessary for Contractor to perform its services. Park Service Manager agrees to provide direction to Contractor as requested regarding particular project requirements.

12. Term of Contract

The awarded contract term is five (5) years, effective from the date of execution of the contract, with the District's option to extend the contract on the same terms for up to three (3) additional one (1) year periods as described below. The District shall not be required to provide "cause" or any reason whatsoever; should it elect not to renew. The contract term and all extensions thereto shall not exceed a total of eight (8) years.

Option to Extend for Good Performance: The District may, at its option, and with the approval of the Contractor, extend the period of the agreement for an additional 12 months up to 3 times. Contractor shall be notified in writing by the District Park Service Manager of the District's

intention to extend the contract period at least ninety (90) calendar days prior to the expiration of the contract. Any price increases or decreases shall be negotiated at time of contract extension.

13. Cancellation

The District reserves the right to cancel this contract at any time if the Contractor fails to provide adequate service or comply with specifications by giving the Contractor thirty (30) days written notice of its intent to do so.

14. Default

If Contractor defaults in its performance of any provision contained in this Contract Agreement, it shall be lawful for District to exercise any and all remedies which may be available to District pursuant to law, and it shall be lawful for District to exercise any and all remedies granted to District pursuant to this Contract Agreement. Each and every covenant and Agreement contained herein to be kept and performed by Contractor is expressly made a condition of this Contract Agreement, and upon the breach thereof, if not remedied by Contractor, District may exercise any and all rights of termination of this Contract Agreement. In the event District determines that Contractor has defaulted in any of its obligations under this Agreement, District shall deliver to Contractor a written notice advising Contractor of the provisions of this Agreement in which it is in default. The notice may also serve as notification that Contractor shall have a right to remedy its defaults in performance of its obligations under this Agreement in accordance with the provisions of this paragraph. If Contractor defaults in the performance of any other obligation under this Agreement, Contractor shall have a period of ten (10) days within which to remedy such default. If Contractor does not remedy a default in its obligations under this Contract Agreement pursuant to the remedy provisions provided above, all rights terminate upon delivery to Contractor of a notice of termination by the District.

15. Compensation

District agrees to pay Contractor for the services provided under this Contract in the amounts at the rates provided in **Exhibits "B"** attached hereto and incorporated by this reference in full herein.

a. Final Pricing

EXHIBIT "B"
SCHEDULE OF PAYMENT
SCHEDULE OF TREE WORK COMPENSATION

The Contractor understands the tree population of the Pleasant Valley Recreation District and agrees to provide the specific services to the District as listed in the Bid Proposal.

1. GRID OR ANNUAL TREE TRIMMING

A systematic tree trimming program composed of existing grid or pre-designed districts that are trimmed in their entirety on a set schedule. Trees in a grid will include all large, medium and small trees. All trimming is performed in accordance with the standards established by the international Society of Arboriculture, American National Standards Institute and the City.

UNIT	UNIT PRICE
Per tree	\$ 75.00

2. FULL TRIM BASED ON SERVICE OR SPECIAL REQUESTS

Trees requiring service prior to their regularly scheduled grid or annual trim to rectify a specific problem such as blocking street lighting or signs, right-of-way clearance for utility lines, or broken limbs will be performed as a "Service Request."

<u>Size</u>	<u>Unit</u>	<u>Unit price</u>
0-6" dbh	per tree	\$ <u>55.00</u>
7-12" dbh	per tree	\$ <u>105.00</u>
13-18 dbh	per tree	\$ <u>139.00</u>
19-24 dbh	per tree	\$ <u>235.00</u>
25-30 dbh	per tree	\$ <u>235.00</u>
31-36 dbh	per tree	\$ <u>365.00</u>
37-42 dbh	per tree	\$ <u>429.00</u>
43 dbh & over	per tree	\$ <u>559.00</u>

3. PALM TREE TRIMMING

	<u>Unit</u>	<u>Unit price</u>
Coco Palm, any size	per tree	\$ <u>60.00</u>
Washingtonia Palm, any size	per tree	\$ <u>70.00</u>
Canary island Date Palm, any size	per tree	\$ <u>295.00</u>

4. TREE REMOVAL

	<u>Unit</u>	<u>Unit price</u>
Complete tree and stump removal	per dbh	\$ <u>37.00</u>
Tree removal only	per dbh	\$ <u>24.00</u>
Stump only removal	per dbh	\$ <u>13.00</u>

5. TREE PLANTING

	<u>Unit</u>	<u>Unit price</u>
15 gallon tree	per tree	<u>\$125.00</u>
15 gallon tree with root barrier	per tree	<u>\$150.00</u>
24 inch box tree	per tree	<u>\$ 250.00</u>
24 inch box tree with root barrier	per tree	<u>\$ 285.00</u>

6. TREE WATERING

<u>Unit</u>	<u>Per day</u>	<u>Unit price</u>
per tree	\$ 600.00	\$ 7.00

7. CREW RENTAL

Per man hour
\$ 75.00

Standard maintenance crew of three (3) persons, one (1) chipper truck, one (1) aerial tower truck and chipper and all necessary saws and hand tools

8. CREW RENTAL (overtime)

Per man hour
\$ 112.00

Standard maintenance crew of three (3) persons, one (1) chipper truck, one (1) aerial tower truck and chipper and all necessary saws and hand tools.

9. EQUIPMENT RATES

List additional equipment you have available and the rates for each.

10. MATERIAL AT COST PLUS _____ 15%

11. ARBORIST SERVICES

Per hour \$125.00

Arborist services provided by the hour as prescribed per the Special Provisions of these Specifications.

12. EMERGENCY CREW RENTAL

Per man hour \$112.00

13. TREE MASTER PLAN

Lump Sum \$15,000.00

14. Equipment Rates

Loader	<u>Per hour</u>	\$125.00
Crane	<u>Per hour</u>	\$125.00
95-ft. Aerial Tower	<u>Per hour</u>	\$125.00

The undersigned hereby accepts the Final Pricing amounts as identified in **section #15 Compensation.**

Signature



Signature

Contractor agrees that payment by District shall not constitute nor be deemed a release of the responsibility and liability of Contractor or its employees, subcontractors, agents and sub-contractors for the accuracy and competency of the information provided and/or services performed hereunder, nor shall such payment be deemed to be an assumption of responsibility or liability by District for any defect or error in the services performed by Contractor, its employees, subcontractors, agents and sub-Contractors.

16. Prevailing Wages

In accordance with California Labor Code Section 1771, Contractor shall pay not less than the general prevailing rate of per diem wages for work of a similar character in the locality in which the Work is to be performed, and not less than the general prevailing rate of per diem wages for holiday and overtime work fixed as provided in the California Labor Code to all workers engaged in performing the Work in accordance with California Labor Code Section 1770 and the State of California Director of Industrial Relations General Prevailing Wage Determination for Tree Trimming in Ventura County. In accordance with California Labor Code Section 1773, the District has obtained the general prevailing rate of per diem wages and the general rate for holiday and overtime work in the locality in which the Work is to be performed for each craft, classification or type of worker needed to perform the project. In accordance with California Labor Code Section 1773.2, copies of the prevailing rate of per diem wages are on file at the District's Public Works Department and will be made available on request. Throughout the performance of the Work the Contractor must comply with all provisions of the Contract Documents and all applicable laws and regulations that apply to wages earned in performance of the Work.

17. Records

Contractor shall provide the Park Service Manager with a completed Request for Taxpayer Identification Number and Certification, as issued by the Internal Revenue Service.

If any sales tax is due for services performed by Contractor or materials or products provided to the District by Contractor, Contractor shall pay the sales tax. District shall not reimburse Contractor for sales taxes paid by Contractor.

18. Method of Payment

District agrees to pay Contractor monthly upon satisfactory completion of the services and upon submission by Contractor of an invoice delineating the services performed, in a form satisfactory to Park Service Manager. The invoice shall identify services by project as specified by the Park Service Manager.

Contractor agrees to maintain current monthly records, books, documents, papers, accounts and other evidence pertaining to the services performed and costs incurred. Such items shall be adequate to reflect the time involved and cost of performing the services. Contractor shall provide Park Service Manager with copies of payroll distribution, receipted bills and other documents requested for justification of the invoice.

19. Responsibility for Expenses

All expenses incident to the performance of services under this Contract shall be done by the Contractor, including, but not limited to rent, vehicle, and travel, entertainment and promotion, general liability and health insurance, workers' compensation insurance, and all compensation and benefits of employees or agents engaged by Contractor. Contractor shall, at its own cost and expense, supply all personal property necessary or appropriate to perform the services provided for under this Contract, including, but not limited to any personal property used by employees and agents of Contractor in the performance of such services.

20. Non-Appropriation of Funds

Payments to be made to Contractor by District for services performed within the current fiscal year are within the current fiscal budget and within an available, unexhausted and unencumbered appropriation of District funds. In the event District does not appropriate sufficient funds for payment of Contractor's services beyond the current fiscal year, this Contract shall cover payment for Contractor's services only up to the conclusion of the last fiscal year in which District appropriates sufficient funds and shall automatically terminate at the conclusion of such fiscal year.

21. Maintenance and Inspection of Records

Contractor agrees that District or its auditors shall have access to and the right to audit and reproduce any of Contractor's relevant records to ensure that District is receiving all services to which District is entitled under this Contract or for other purposes relating to the Contract. Contractor shall maintain and preserve all such records for a period of at least three years after the expiration of this Contract, or until an audit has been completed and accepted by District. Contractor agrees to maintain all such records in District or to promptly reimburse District for all reasonable costs incurred in conducting the audit at a location other than in District, including but not limited to expenses for personnel, salaries, private auditor, travel, lodging, meals and overhead.

22. Confidentiality of Information

Any documents and materials given to or prepared or assembled by Contractor under this Contract shall be confidential and shall not be made available to any third person or organization by Contractor without prior written approval of the Park Service Manager.

23. Indemnity

The Contractor hereby agrees to defend at his own cost and to indemnify and hold harmless the District and its officers, agents, volunteers and employees ("District's Parties"), from and against any and all liability, damages, costs, losses, claims, and expenses, howsoever caused, resulting directly or indirectly from or connected with the performance of the Contract (including but not limited to such liability, costs, damage, loss, claim, or expense arising from (a) the death or injury to an agent or employee of the Contractor, subcontractor, the District, the District's Parties or a District visitor, (b) loss of, damage to, or destruction of the property of Contractor, subcontractor, the District, the District's Parties, a District visitor, or of any agent or employee of the Contractor or a subcontractor, (c) the failure to pay or properly pay prevailing wages, or (d) the failure to maintain adequate insurance coverage), except where such liability, damages, costs, losses, claims or expenses are caused solely by the negligent or wrongful acts of the District or District's Parties in connection with the general supervision or direction of the work to be performed hereunder. The Contractor in addition to the foregoing, specifically shall indemnify and save harmless the District and the District's Parties from any liability by reason of California safe place statutes or similar provisions pertaining to the work place or safety of materials or equipment supplied by the District or others at the direction of the District and used in the performance of the work hereunder.

The Contractor shall indemnify the District and District Parties from all loss, damage, liability, cost, and expense to which any such parties may be put by reason of any negligent or wrongful act or omission on the part of the Contractor's employees or agents engaged in the work to be done hereunder in supervising the erection or installation of any apparatus which may be required by or incidental to performance of this contract.

Contractor shall require his subcontractors to afford the same degree of indemnification to the District that is required of Contractor, and shall incorporate identical indemnity provisions in all contracts between Contractor and his subcontractors.

24. Insurance

Contractor shall obtain and maintain during the performance of any services under this Contract the insurance coverage as specified herein by this reference, issued by a company satisfactory to the District, unless the District waives, in writing, the requirement that Contractor obtain and maintain such insurance coverage. Maintenance of proper insurance coverage by Contractor is a material element of this Contract. Contractor's failure to maintain or renew insurance coverage or to provide evidence of renewal may be considered as a material breach of this Contract.

Contractor shall carry, and shall require all of his subcontractors to carry insurance in limits or amounts not less than the following:

Contractor shall procure and maintain for the duration of the contract the following insurance coverage's and limits against claims for injuries to persons or damage to property, which may

arise from or in connection with the performance of the work covered by this agreement by the Contractor, his agents, representatives, employees or subcontractors:

<u>COVERAGE PER OCCURRENCE</u>	<u>COMBINED</u> <u>ISO FORM</u>	<u>SINGLE LIMIT</u>
Comprehensive General Liability or Broad Form General Liability	GL 00 02 01 73 Rev GL 04 04 05 81	\$3,000,000 \$3,000,000
Business Auto	CA 00 01 01 87	\$1,000,000
Worker's Compensation		Statutory Limit
• Including Employers' Liability And Waiver of Subrogation		\$1,000,000

Worker's Compensation. The Contractor shall comply with all of the provisions of the Workmen's Compensation Insurance and Safety Acts of the State of California, the applicable provisions of Division 4 and 5 of the California Labor Code and all amendments thereto; and all similar State or Federal acts or laws applicable.

Contractor shall provide Additional Insured Endorsements for General Liability & Auto coverage's and endorsements or other proof of coverage for the following specific coverage's:

- Environmental hazards, collapse, and underground property coverage;
- Contractual liability; and
- Products and completed operations.

Combined single limit per occurrence shall include coverage for bodily injury, personal injury, and property damage for each accident.

If Commercial General Liability insurance or other form with a general aggregate limit is used, the policy shall be endorsed such that the general aggregate limit shall apply separately to this contract and a copy of the endorsement provided to the District.

Policies of all subcontractors shall be subject to the same requirements and provisions outlined above applying to Contractor.

Each insurance policy required by this subsection shall be endorsed to state that coverage shall not be suspended, voided, cancelled by either party, reduced in coverage or in limits, except after thirty (30) days written notice by certified mail, return receipt requested, has been given to:

Pleasant Valley Recreation and Park District
ATTN: PARK OFFICE
1605 E Burnley Street
Camarillo, CA 93010

Contractor shall furnish to the District certificates of Liability Insurance and endorsements duly authenticated, given evidence of insurance coverages required in the contract and other evidence of or copy of policy as may be reasonably required by the District from time to time. The insurance shall be placed with insurers with the current year Best's Key Rating Guide of not less than A:VII where A = Excellent and VII = \$50,000,000 thru \$100,000,000. The insurer must be a "California Admitted" carrier.

All subcontractors employed on the work referred to in these Terms and Conditions shall meet the insurance requirements set forth for Contractor. Contractor shall furnish certificates of insurance and endorsements for each subcontractor at least five (5) days prior to the subcontractor entering the job site, or contractor shall furnish the District an endorsement including all subcontractors as insured under its policy. Self-insured contractor will provide equivalent documentation and proof of coverage naming the district, as outlined above.

Worker's Compensation Insurance and Comprehensive Liability Insurance (bodily injury, personal injury and property damage) including automobiles and including liability assumed by Contractor, is to be procured and maintained at the sole expense of Contractor during the performance of any work or activities under this contract. The insurer shall agree to waive all rights and subrogation against the District and District's Parties for losses arising from work performed by the Contractor for the District.

The Comprehensive Liability Insurance shall name the District and District's Parties as insureds with respect to liability of any nature arising out of or incidental to the performance of his Contract, and shall further provide that the protection afforded the District and District's Parties shall be primary insurance protection and not contributing with any other valid and collectible insurance of the District.

25. Independent Contractor

District and Contractor agree that in the performance of the services, Contractor shall be, and is; an independent contractor, and that Contractor and its employees are not employees of District. Contractor has and shall retain the right to exercise full control over the employment, direction, compensation and discharge of all persons assisting Contractor. Contractor shall be solely responsible for, and shall save District harmless from, all matters relating to the payment of Contractor's employees, agents, and subcontractors including compliance with social security requirements, Federal and State income tax withholding and all other regulations governing employer-employee relations. Contractor acknowledges that Contractor and Contractor's employees and subcontractors are not entitled to receive from District any of the benefits or rights afforded employees of District, including but not limited to reserve leave, sick leave, vacation leave, holiday leave, compensatory leave, Public Employees Retirement System benefits, or health, life, dental, short term & long-term disability and workers' compensation

insurance benefits.

26. Conflict of Interest

Contractor shall promptly inform Park Service Manager of any contract, arrangement, or interest that Contractor may enter into or have during the performance of this Contract that may conflict with District's interests. This requirement includes contracts and arrangements with manufacturers, suppliers, contractors or other clients whose interests might be served by the services performed under this Contract and Contractor's or Contractor's clients' interest in land that might be affected by the services. Contractor shall take such measures as are necessary in the performance of this Contract to prevent actual or appearances of conflicts of interest.

District. No officer or employee of District shall have a financial interest in this Contract nor shall any such officer or employee participate in any decision relating to the Contract which affects his financial interest or the financial interest of any corporation, partnership or association in which he is interested, in violation of any State statute or regulation.

Contractor. Contractor warrants that it has not paid or given and will not pay or give any third party any money or other consideration for obtaining this Contract. Contractor shall comply with all conflict of interest laws and regulations including, without limitation, District's Conflict of Interest Code which is on file in the District's office.

27. Assignability of Contract

Contractor agrees that this Contract contemplates personal performance by Contractor and is based upon a determination of Contractor's personnel's unique competence, experience and specialized knowledge. Assignments of any or all rights, duties, or obligations of Contractor under this Contract will be permitted only with the express written consent of Park Supervisor Matthew Parker, which consent may be withheld for any reason.

28. Successors and Assigns

Contractor and District agree that this Contract shall be binding upon and inure to the benefit of the heirs, executors, administrators, successors and assigns of Contractor and District.

29. Fair Employment Practices

Contractor agrees that, during the performance of this Contract, Contractor and any other parties with whom Contractor may subcontract shall adhere to equal opportunity employment practices to assure that applicants and employees are treated equally and are not discriminated against because of their race, color, religion, ancestry, national origin, disability, sex, marital status, age, or any other status protected by law.

Contractor agrees that all persons employed by Contractor shall be treated equally by Contractor without regard to or because of race, color, religion, ancestry, national origin, disability, sex, marital status, age, or any other status protected by law, and in compliance with all antidiscrimination laws of the United States of America, the State of California, County of Ventura, and City of Camarillo.

Contractor agrees to state in all of its solicitations or advertisements for applicants for employment that all qualified applicants shall receive consideration for employment without regard to their race, color, religion, ancestry, national origin, disability, sex, marital status, age, or any other status protected by law.

Contractor shall provide Districts staff with access to and, upon request by Park Service Manager, provide copies to Park Service Manager of all of Contractor's records pertaining or relating to Contractor's employment practices, to the extent such records are not confidential or privileged under State or Federal law.

30. Force Majeure

Contractor and District agree that neither District nor Contractor shall be responsible for delays or failures in performance resulting from acts beyond the control of either party. Such acts shall include, but not be limited to acts of God, strikes, lockouts, riots, acts of war, epidemics, governmental regulations imposed after this Contract was executed, fire, communication line failures, earthquakes, or other disasters.

31. Time of Essence

Contractor and District agree that time is of the essence in regard to performance of any of the terms and conditions of this Contract.

32. Covenants and Conditions

District and Contractor agree that the construction and interpretation of this Contract and the rights and duties of District and Contractor hereunder shall be governed by the laws of the State of California.

33. Compliance with Laws

Contractor agrees to comply with all City, State, and Federal laws, rules, and regulations, now or hereafter in force, pertaining to the services performed by Contractor pursuant to this Contract including all environmental laws and applicable mandatory standards and policies relating to energy efficiency and all air pollution control rules and regulations including but not limited to the requirements of Government Code Section 11017.

34. Severability

District and Contractor agree that the invalidity in whole or in part of any provision of this Contract shall not void or affect the validity of any other provision.

35. Waiver

District and Contractor agree that no waiver or a breach of any provision of this Contract by either Contractor or District shall constitute a waiver of any other breach of the same provision or any other provision of this Contract. Failure of either District or Contractor to enforce at any time, or from time to time, any provision of this Contract, shall not be construed as a waiver of such provision or breach.

36. Counterparts

District and Contractor agree that this Contract may be executed in two or more counterparts, each of which shall be deemed an original.

37. Expenses of Enforcement

Contractor and District agree that the prevailing party's reasonable costs, attorneys' fees (including the reasonable value of the services rendered by the District's legal Counsel Office) and expenses, including investigation fees and expert witness fees, shall be paid by the non-prevailing party in any dispute involving the terms and conditions of this Contract.

38. Authority to Execute

District acknowledges that the person executing this Contract has been duly authorized by the District to do so; on behalf of District.

Contractor acknowledges that the person executing this Contract has been duly authorized by Contractor to do so; on behalf of Contractor.

39. Notices

Any notices to Contractor may be delivered personally or by mail addressed to:

**West Coast Arborists, Inc.
Attention: Patrick Mahoney
2200 E. Via Burton St.
Anaheim, CA 92806
T: (714) 991-1900
F: (714) 956-3745**

Any notices to District may be delivered personally or by mail addressed to:

**Pleasant Valley Recreation and Park District
Attention: Park Office, Matthew Parker
480 Skyway Drive
Camarillo, California 93010**

40. Amendment



District and Contractor agree that the terms and conditions of the Contract may be reviewed or modified at any time. Any modifications to this Contract, however, shall be effective only when agreed to in writing by both Park Service Manager and Contractor.

41. Entire Contract

District and Contractor agree that this Contract and the accompanying attachments constitutes the entire Contract of the parties regarding the subject matter described herein and supersedes all prior communications, Contracts, and promises, either oral or written.

District:
Pleasant Valley Recreation and Park District
1605 E. Burnley St.
Camarillo, CA 93010

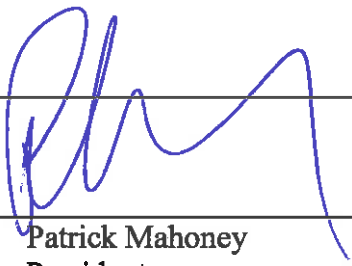
Contractor:
West Coast Arborists, Inc.
2200 E. Via Burton St.
Anaheim, CA 92806

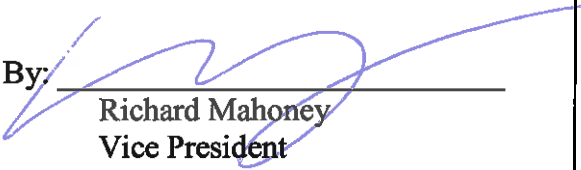
By: <u></u> Mary Otten General Manager	By: <u></u> Patrick Mahoney President
Attest: <u></u> Mitchell Cameron Clerk of Board	By: <u></u> Richard Mahoney Vice President

**THIRD AMENDMENT TO CONTRACT SERVICES AGREEMENT
FOR TREE TRIMMING AND TREE MAINTENANCE SERVICES**

This THIRD AMENDMENT TO CONTRACT SERVICES AGREEMENT (the “Third Amendment”) is made and entered into this 1st day of July 2024, by and between the PLEASANT VALLEY RECREATION AND PARK DISTRICT, a public agency (“District”), and WEST COAST ARBORISTS, INC., a California corporation (herein “Contractor”).

RECITALS

WHEREAS, District and Contractor entered into that certain Agreement entitled “Contract Services Agreement for Tree Trimming and Tree Maintenance Services” (the “Agreement”) on or about July 3, 2017; and

WHEREAS, District and Contractor entered into that certain “Second Amendment to Contract Services Agreement for Tree Trimming and Tree Maintenance Services (the “Second Amendment”) on or about July 1, 2023; and

WHEREAS, it is the desire of the District and the Contractor to further amend the Agreement, as set forth in this Third Amendment.

AGREEMENT

NOW, THEREFORE, it hereby agreed that the Agreement, as amended, is further amended in the following particulars only:

SECTION 15. Effective July 1, 2024, the entire section of the Agreement, entitled “Compensation”, is replaced with Exhibit B-1, which exhibit is incorporated herein by this reference as if set forth in full. All references to Exhibit “B” in the Agreement after the date of this Third Amendment shall mean and refer to both Exhibit “B” and Exhibit “B-1”.

SECTION 12. Section 12 of the Agreement is hereby amended to extend the Term for completion of services for the agreement including this and all previous amendments to July 1, 2025.

SECTION 2. Except as expressly provided for in this Third Amendment, all other provisions of the Agreement, as amended, shall remain in full force and effect.

IN WITNESS WHEREOF, the parties have executed and entered into this Third Amendment as of the date first written above.

[SIGNATURES NEXT PAGE]

DISTRICT:

By: _____
Mary Otten, General Manager

Date: _____

ATTEST:

Jessica A. Puckett, Clerk

Date: _____

CONTRACTOR:

By: _____
Patrick Mahoney
President

By: _____
Richard Mahoney
Vice President

Address: 2200 E. Via Burton
Anaheim, California 92806

Date: _____



Schedule of Compensation for Year 2023 - 2024

Tree Maintenance Services performed by WCA, Inc.

Item	Description	Unit	Proposed Prices
1	Grid Pruning	Each	\$82.65
2	Full Pruning 0-6 DSH	Each	\$60.60
3	Full Pruning 7-12 DSH	Each	\$115.70
4	Full Pruning 13-18 DSH	Each	\$153.20
5	Full Pruning 19-30 DSH	Each	\$259.00
6	Full Pruning 31-36 DSH	Each	\$402.20
7	Full Pruning 37-42 DSH	Each	\$472.75
8	Full Pruning >42 DSH	Each	\$616.00
9	Coco Palm Pruning	Each	\$66.15
10	Washingtonia Palm Pruning	Each	\$77.25
11	Date Palm Pruning	Each	\$325.00
12	Tree & Stump Removal	Inch	\$40.80
13	Tree Only Removal	Inch	\$26.45
14	Stump Only Removal	Inch	\$14.30
15	Plant 15 Gal w/o RB	Each	\$137.75
16	Plant 15 Gal w/ RB	Each	\$165.30
17	Plant 24" Box w/o RB	Each	\$275.50
18	Plant 24" Box w/ RB	Each	\$314.00
19	Tree Watering	Each	\$7.70
20	Tree Watering	Day	\$661.25
21	Arborist Services	Man Hour	\$137.75
22	Crew Rental - per man	Man Hour	\$82.65
23	Emergency Response - per man	Man Hour	\$123.45
24	Specialty Equipment Rental with operator	Hour	\$137.75

EXHIBIT B

The Agreement is for 5 years with 3 annual options. There are 2 remaining options. We propose a 3% cost adjustment to help offset the rise in operating costs. Upon approval, the rates will be effective 7/1/2023 and valid for 12 months.



Schedule of Compensation for Year 2024 - 2025

Tree Maintenance Services performed by WCA, Inc.

Item	Description	Unit	Proposed Prices
1	Grid Pruning	Each	\$86.80
2	Full Pruning 0-6 DSH	Each	\$62.40
3	Full Pruning 7-12 DSH	Each	\$119.15
4	Full Pruning 13-18 DSH	Each	\$157.80
5	Full Pruning 19-30 DSH	Each	\$266.75
6	Full Pruning 31-36 DSH	Each	\$414.25
7	Full Pruning 37-42 DSH	Each	\$486.95
8	Full Pruning >42 DSH	Each	\$634.50
9	Coco Palm Pruning	Each	\$68.15
10	Washingtonia Palm Pruning	Each	\$79.55
11	Date Palm Pruning	Each	\$334.75
12	Tree & Stump Removal	Inch	\$42.00
13	Tree Only Removal	Inch	\$27.25
14	Stump Only Removal	Inch	\$14.75
15	Plant 15 Gal w/o RB	Each	\$141.90
16	Plant 15 Gal w/ RB	Each	\$170.25
17	Plant 24" Box w/o RB	Each	\$283.75
18	Plant 24" Box w/ RB	Each	\$323.40
19	Tree Watering	Each	\$7.95
20	Tree Watering	Day	\$681.10
21	Arborist Services	Man Hour	\$141.90
22	Crew Rental - per man	Man Hour	\$85.15
23	Emergency Response - per man	Man Hour	\$127.15
24	Specialty Equipment Rental with operator	Hour	\$141.90

EXHIBIT B-1

The proposed rates will undergo a 3.0% adjustment, except for Grid Pruning, which will see a cost increase of 5%, effective 7/1/24 pending approval.

**PLEASANT VALLEY RECREATION AND PARK DISTRICT
STAFF REPORT / AGENDA REPORT**

TO: BOARD OF DIRECTORS

FROM: MARY OTTEN, GENERAL MANAGER
By: Jennifer Strain, Administrative Analyst

DATE: May 1, 2024

**SUBJECT: CONSIDERATION AND ACCEPTANCE OF SITELOGIQ
PROJECT SCOPE AND DIRECTION FOR STAFF TO
PROCEED WITH A PUBLIC HEARING FOR
RENEWABLE ENERGY AND ENERGY EFFICIENCY
UPGRADES TO DISTRICT FACILITIES**

SUMMARY

On October 4, 2023, the District Board of Directors approved the General Manager to enter into an agreement with SitelogIQ, Inc. (SitelogIQ) to perform a Districtwide audit of facilities and to develop an energy efficiency program. In accordance with California Government Code 4217.10 et seq., SitelogIQ's criteria was to develop an energy upgrade program that would be self-funded through utility cost savings. On March 19, 2024, SitelogIQ presented a preliminary program proposal to District Staff which included solar photovoltaic generation systems, energy storage, electric vehicle charging stations, HVAC systems and controls, and lighting upgrades. District Staff and SitelogIQ have established a program that will help the District lower utility costs, provide additional disaster response resources to District residents, and support clean and renewable energy initiatives.

BACKGROUND

District Staff and SitelogIQ began a District wide energy audit of all 28 District owned facilities and parks, on November 29, 2023. This audit included inspections of all HVAC systems, electrical panels and meters, exterior and interior lighting systems, and aquatic equipment located at the Community Center Park and District Administration Office, Bob Kildee Community Park and Aquatic Center, Freedom Park and District Park Office, Pleasant Valley Fields, and all Sports, Community, and Neighborhood Parks. In addition to on-site visits and equipment inspections, SitelogIQ performed an audit of District utility accounts.

SitelogIQ met with Staff on March 19, 2024, to review the proposed final program scope for District energy efficiency upgrades. This program would include the installation of solar photovoltaic systems, energy storage, electrical vehicle charging stations, HVAC systems and controls, and interior lighting upgrades to District facilities and parks; Community Center Park & District Administration Office, Bob Kildee Community Park & Aquatic Center, Freedom Park & District Park Office, and Pleasant Valley Fields. The program scope presented met the criteria to

be self-funded through energy cost avoidance and satisfied Staff’s request to establish a program with no up-front contribution from the District.

Staff and SitelogIQ presented the final program proposal to the District Finance Committee on April 17, 2024, where Staff were directed to present the program at the District’s Board of Directors Meeting on May 1, 2024.

ANALYSIS

In 2015 California State Senate Bill 350, The Clean Energy and Pollution Reduction Act, was passed to establish clean energy, clean air, and greenhouse gas reduction goals to reduce greenhouse gases to 80 percent below 1990 levels by the year 2050. In support of this, the California Energy Commission (CEC) has established several pathways to help the State achieve this goal, one of which is a program for Energy Efficiency in Existing Buildings Action Plan. This plan is required by California Assembly Bill 758 which recognizes the need for California to address climate change through reduced energy consumption in existing buildings. Within this action plan, the Local Government Challenge Program Strategy (S 1.7) encourages local governments to implement innovative efficiency programs, example given: aggressive efficiency for public buildings.

The proposed program will ensure the District is making an impactful contribution towards the State’s measures to implement green energy solutions and reduce its greenhouse gas emissions. The established program includes the following components and District facilities:

	Interior & Exterior Lighting	HVAC System Replacement	HVAC Wireless Controls	Solar Photovoltaic System	Energy Storage Battery	Electric Vehicle Charging	Parking Lot Remediation
Bob Kildee Community Park	Retrofit/Upgrade of 40 non-LED fixtures						
Freedom Park & District Park Office				70.9 kW Solar-PV canopy system		(2) Dual-port level 2 chargers	Slurry coat and re-stripe
Pleasant Valley Fields				98.1 kW Solar-PV canopy system		(2) Dual-port level 2 chargers	Slurry coat and re-stripe
Community Center Park & District Administration Office		(1) 2 ton pkg unit (5) 3 ton pkg unit (1) 5 ton pkg unit (2) 10 ton pkg unit (4) 15 ton pkg unit (2) nominal tonnage pkg unit	(18) wireless smart thermostats	85.9 kW Solar-PV canopy system	100 kW / 372kWh	(2) Dual-port level 2 chargers	Partial parking lot remediation

- Interior and Exterior Lighting – Bob Kildee Community Park
- HVAC Systems and Controls – Community Center Park & District Administration Office
- Solar Photovoltaic Systems – Freedom Park & District Park Office, Pleasant Valley Fields, and Community Center Park & Administration Office

- Battery Energy Storage – Community Center Park & District Administration Office
- Electric Vehicle (EV) Charging Stations – Freedom Park & District Park Office, Pleasant Valley Fields, and Community Center Park & Administration Office
- Parking Lot Remediation – Freedom Park & District Park Office, Pleasant Valley Fields, and Community Center Park & Administration Office

Energy efficient lighting upgrades are needed for exterior fixtures at Bob Kildee Community Park. The benefits to upgrading these exterior lights at this facility include energy conservation, but they also make an impact to overall useful life of each fixture and lamp, and their compatibility with future replacement parts and lamps. A total of 40 non-LED exterior light fixtures will be replaced.

Within the Community Center Park and District Administration Office buildings, the aging HVAC systems lack essential energy saving components that allow them to perform efficiently with fewer greenhouse gas emissions. In addition to the units themselves, the thermostat controls allow for temperature control but do not allow for scheduling or remote access. By upgrading the HVAC package units, the District can reduce both excess emissions and consumption of utilities. Through using wireless thermostat controls, Staff will be able to monitor temperatures, schedule on/off times, and ensure units are not in use when buildings are unoccupied. Any HVAC units less than 15 years old will not be replaced in this project. A total of 15 units and 18 wireless smart thermostats will be installed. The District has budgeted \$585,000 for fiscal years 2026 and 2027 toward the replacement of these units. The projected utility cost avoidance from the LED lighting and HVAC energy efficiency upgrades is estimated at \$753,729 over 20 years.

Solar photovoltaic (PV) systems are an essential part of the strategies outlined in both SB 350 and the CEC's Energy Efficiency in Existing Buildings Action Plan. Three (3) solar PV canopy systems are planned for Community Center Park, Freedom Park, and Pleasant Valley Fields. Solar PV generates clean renewable energy and will greatly reduce the District's utility consumption during essential programs and services in indoor facilities. These systems will also relieve the surrounding grid from significant daily impact, especially during wildfire season when Public Safety Power Shutoffs become necessary. In addition to supporting indoor facilities, the solar PV systems will supply power to a total of six (6) dual-port EV charging stations. The projected utility cost avoidance from the use of solar PV generation is estimated at \$2,861,624 over 30 years.

Community Center Park has long served as a registered shelter for disaster emergencies with the American Red Cross. Often, in the event of disasters that require the evacuation of residents, loss of utilities for an extended period of time should be anticipated. This program includes the installation of a 372kW/h storage battery which would allow for 372kW/h of energy. Battery energy storage will provide valuable support in the event of an emergency disaster. In addition to improving disaster resiliency, the battery system will provide its excess generated energy to the grid during times of peak energy consumption. The projected utility cost avoidance for battery energy storage is estimated at \$888,017 over 20 years. Additionally, the CEC offers incentives to customers who provide load reduction through the Demand Side Grid Support (DSGS) Program. The District will receive DSGS program incentive payments estimated at \$461,560 over 20 years.

The Advanced Clean Fleet (ACF) regulation, approved by the California Air Resources Board effective January 1, 2024, requires 50 percent of District purchased vehicles to be zero-emission vehicles (ZEV). The District currently does not have the infrastructure to support the charging of

ZEVs. This program will provide two (2) dual-port level 2 electric vehicle (EV) chargers at Community Center Park, Freedom Park, and Pleasant Valley Fields, which will be a vital component to supporting District vehicles as they are phased into the fleet. In addition to this benefit, by making these charging stations available to District residents and guests, the District will provide support to the growing network of electric ZEV/PZEV vehicles at facilities and parks. These EV charging stations will also establish a new revenue stream, which will help to offset their operation and maintenance costs. The projected revenue for EV charging stations is estimated at \$315,939 over 20 years.

The 30-year projected utility cost avoidance and total gross program savings are estimated at \$6,641,524. Estimated project costs of \$4,478,940, \$0 in upfront District contribution, and \$216,060 Capitalized interest total an all-in cost of \$4,695,000. There is an Estimated Inflation Reduction Act (IRA) refund of \$1,239,790, which is expected to be disbursed in December of 2025. With a projected fixed interest rate of 4.83% and a 20-year payment period, the total payment would be \$5,161,192. Comparing savings to the lease payment, the estimated total net program savings is \$1,480,332.

FISCAL IMPACT

If the District enters into an agreement with SitelogIQ, a 20-year equipment lease will be procured to pay for the project. The payments are front-loaded for the first three payments due to the expectation of the IRA refund being disbursed in December of 2025. The estimated 20-year lease, calculated with a fixed interest rate of 4.83%, is \$5,161,192. The 30-year total program savings is estimated to be \$6,641,524, with a net savings of \$1,480,332. This program will allow the District to remain in a positive cash flow position by offsetting annual lease payments with program savings. The estimated average annual savings to the District for years 1-20 is \$4,923; estimated average annual savings in years 21-30 is \$125,625.

The following chart shows the estimated payment schedule:

Year	Total Program Savings	Lease Payment *Net of CAPI	Net Savings	Cumulative Savings
0	\$12,702	CAP I YEAR	\$12,702	\$12,702
1	\$603,379	(\$598,417)	\$4,961	\$17,663
2	\$610,295	(\$604,031)	\$6,264	\$23,927
3	\$325,106	(\$318,976)	\$6,130	\$30,057
4	\$183,669	(\$180,200)	\$3,469	\$33,527
5	\$191,841	(\$188,012)	\$3,829	\$37,356
6	\$200,481	(\$197,269)	\$3,212	\$40,568
7	\$209,615	(\$205,922)	\$3,693	\$44,260
8	\$219,271	(\$214,923)	\$4,348	\$48,608
9	\$229,481	(\$225,248)	\$4,233	\$52,841
10	\$200,374	(\$196,234)	\$4,140	\$56,981
11	\$209,472	(\$205,873)	\$3,599	\$60,580
12	\$219,090	(\$214,811)	\$4,279	\$64,859
13	\$229,257	(\$224,977)	\$4,280	\$69,138
14	\$240,004	(\$235,321)	\$4,683	\$73,822
15	\$251,366	(\$246,796)	\$4,570	\$78,392
16	\$254,975	(\$250,330)	\$4,645	\$83,037

17	\$276,076	(\$271,066)	\$5,010	\$88,047
18	\$289,500	(\$284,353)	\$5,147	\$93,194
19	\$303,693	(\$298,433)	\$5,260	\$98,453
20	\$213,320		\$213,320	\$311,773
21	\$88,160		\$88,160	\$399,933
22	\$93,571		\$93,571	\$493,504
23	\$99,308		\$99,308	\$592,812
24	\$105,390		\$105,390	\$698,202
25	\$111,837		\$111,837	\$810,040
26	\$118,672		\$118,672	\$928,712
27	\$125,918		\$125,918	\$1,054,630
28	\$133,598		\$133,598	\$1,188,227
29	\$141,738		\$141,738	\$1,329,966
30	\$150,366		\$150,366	\$1,480,332
Total	\$6,641,524	(\$5,161,192)	\$1,480,332	-

If the District does not accept and proceed with any project proposed within 60 days, the District will pay SitelogIQ a development fee of \$24,150.

If the District accepts and proceeds with any project proposed after 60 days, the development fee of \$24,150 will be credited toward the project's total cost.

STRATEGIC PLAN COMPLIANCE

Meets 2021-2026 Strategic Plan Goals and Strategies:

- **1.1:** Review costs, revenues, and subsidies for program and rentals.
- **1.3:** Identify additional sources of revenue to reduce the reliance of property tax.
- **1.4:** Create Green Initiatives and Sustainability Program to encourage more efficient design and usage of our park system, respect of our natural environments, and to capitalize on the cost savings of these methods as well as grant opportunities.

RECOMMENDATION

It is recommended that the Board of Directors accept the project and direct Staff to work with SitelogIQ, Inc. on a Notice of a Public Hearing, to be read at the District's Board of Directors Meeting on June 5, 2024.

ATTACHMENTS

- 1) SitelogIQ Financial Proforma (1 page)

Financial Proforma
RENEWABLE ENERGY & ENERGY EFFICIENCY PROGRAM
Pleasant Valley Recreation and Park District
April 17, 2024

Scope: Solar PV @ 3 sites
 Energy Storage @ Community Ctr
 EV Charging @ 3 sites
 Air Conditioning & Controls
 Lighting @ Bob Kildee

Program Implementation Cost: \$4,478,940
 District Contribution: **\$0**
 Lease Transaction Costs: incl. above
 Capitalized Interest ("CAPI"): **\$216,060**

Remaining amount to fund: \$4,695,000

Estimated IRA Contribution: **(\$1,239,790)** * Dec. 2025, prepayment

Utility Escalation:
5.80%

Interest Rate:
4.83%

1	Program Savings, Contributions & On-going Services										12
	2	3	4	5	6	7	8	9	10	11	
Year	Utility Cost Avoidance				Field Lighting Savings	Capital Cost & Maintenance Savings	Incentives, Grants & Rebates (DSGS Program)	EV Charging Revenue	Solar Maintenance Services	Energy Management Services	Total Program Savings
	Solar-PV Generation (NEM 2.0)	Solar-PV Generation (NEM 3.0)	Energy Storage	Energy Efficiency							
0	-	-	-	\$12,702	scope not incl.	-	-	-	-	↓ optional ↓	\$12,702
1	\$37,385	\$20,540	\$24,664	\$22,397		\$481,667	\$15,500	\$8,775	(\$7,550)		\$603,379
2	\$39,554	\$21,731	\$26,095	\$23,696		\$481,667	\$16,120	\$9,284	(\$7,852)		\$610,295
3	\$41,848	\$22,992	\$27,608	\$25,071		\$189,167	\$16,765	\$9,822	(\$8,166)		\$325,106
4	\$44,275	\$24,325	\$29,209	\$26,525		\$40,000	\$17,435	\$10,392	(\$8,493)		\$183,669
5	\$46,843	\$25,736	\$30,904	\$28,063		\$40,000	\$18,133	\$10,995	(\$8,832)		\$191,841
6	\$49,560	\$27,229	\$32,696	\$29,691		\$40,000	\$18,858	\$11,633	(\$9,186)		\$200,481
7	\$52,434	\$28,808	\$34,592	\$31,413		\$40,000	\$19,612	\$12,307	(\$9,553)		\$209,615
8	\$55,476	\$30,479	\$36,599	\$33,235		\$40,000	\$20,397	\$13,021	(\$9,935)		\$219,271
9	\$58,693	\$32,247	\$38,721	\$35,163		\$40,000	\$21,213	\$13,776	(\$10,333)		\$229,481
10		\$56,314	\$40,967	\$37,202		\$40,000	\$22,061	\$14,575	(\$10,746)		\$200,374
11		\$59,580	\$43,343	\$39,360		\$40,000	\$22,944	\$15,421	(\$11,176)		\$209,472
12		\$63,036	\$45,857	\$41,643		\$40,000	\$23,862	\$16,315	(\$11,623)		\$219,090
13		\$66,692	\$48,517	\$44,058		\$40,000	\$24,816	\$17,261	(\$12,088)		\$229,257
14		\$70,560	\$51,331	\$46,613		\$40,000	\$25,809	\$18,263	(\$12,571)		\$240,004
15		\$74,653	\$54,308	\$49,317		\$40,000	\$26,841	\$19,322	(\$13,074)		\$251,366
16		\$78,983	\$57,458	\$52,177		\$40,000	\$27,915	\$20,442	(\$22,000)		\$254,975
17		\$83,564	\$60,791	\$55,204		\$40,000	\$29,031	\$21,628	(\$14,141)		\$276,076
18		\$88,410	\$64,316	\$58,405		\$40,000	\$30,192	\$22,883	(\$14,707)		\$289,500
19		\$93,538	\$68,047	\$61,793		\$40,000	\$31,400	\$24,210	(\$15,295)		\$303,693
20		\$98,963	\$71,993				\$32,656	\$25,614	(\$15,907)		\$213,320
21		\$104,703							(\$16,543)		\$88,160
22		\$110,776							(\$17,205)		\$93,571
23		\$117,201							(\$17,893)		\$99,308
24		\$123,998							(\$18,609)		\$105,390
25		\$131,190							(\$19,353)		\$111,837
26		\$138,799							(\$20,127)		\$118,672
27		\$146,850							(\$20,932)		\$125,918
28		\$155,367							(\$21,769)		\$133,598
29		\$164,378							(\$22,640)		\$141,738
30		\$173,912							(\$23,546)		\$150,366
Totals	\$426,069	\$2,435,555	\$888,017	\$753,729	-	\$1,792,500	\$461,560	\$315,939	(\$431,844)	-	\$6,641,524

13	14	15
Lease Payment	Net Savings	Cumulative Savings
*Net of CAPI		
CAP I YEAR	\$12,702	\$12,702
(\$598,417)	\$4,961	\$17,663
(\$604,031)	\$6,264	\$23,927
(\$318,976)	\$6,130	\$30,057
(\$180,200)	\$3,469	\$33,527
(\$188,012)	\$3,829	\$37,356
(\$197,269)	\$3,212	\$40,568
(\$205,922)	\$3,693	\$44,260
(\$214,923)	\$4,348	\$48,608
(\$225,248)	\$4,233	\$52,841
(\$196,234)	\$4,140	\$56,981
(\$205,873)	\$3,599	\$60,580
(\$214,811)	\$4,279	\$64,859
(\$224,977)	\$4,280	\$69,138
(\$235,321)	\$4,683	\$73,822
(\$246,796)	\$4,570	\$78,392
(\$250,330)	\$4,645	\$83,037
(\$271,066)	\$5,010	\$88,047
(\$284,353)	\$5,147	\$93,194
(\$298,433)	\$5,260	\$98,453
	\$213,320	\$311,773
	\$88,160	\$399,933
	\$93,571	\$493,504
	\$99,308	\$592,812
	\$105,390	\$698,202
	\$111,837	\$810,040
	\$118,672	\$928,712
	\$125,918	\$1,054,630
	\$133,598	\$1,188,227
	\$141,738	\$1,329,966
	\$150,366	\$1,480,332
(\$5,161,192)	\$1,480,332	-

**PLEASANT VALLEY RECREATION AND PARK DISTRICT
STAFF REPORT / AGENDA REPORT**

TO: BOARD OF DIRECTORS

FROM: MARY OTTEN, GENERAL MANAGER
By: Matthew Parker, Park Services Manager

DATE: May 1, 2024

**SUBJECT: CONSIDERATION AND APPROVAL OF THE DESIGN
AND CONSTRUCTION PLANS FROM KIDSTREAM
FOR THE SHARED PARKING LOT EXPANSION AT
BOB KILDEE PARK ON THE ESTON STREET SIDE**

SUMMARY

The Pleasant Valley Recreation & Park District (District) and kidSTREAM have formed various partnerships over the course of the last decade. kidSTREAM entered into an initial agreement with the City of Camarillo (City) in June of 2018 for the sale of the former library located at 3100 Ponderosa Drive, which is located adjacent to Bob Kildee Community Park. Following the approved donation on March 24, 2021, the City performed a parking calculation and confirmed that there are not enough parking spaces for kidSTREAM in their current designated parking lot. To assist in moving the project forward, the District has worked with kidSTREAM to expand the current parking lot to accommodate the required parking needs. The design and construction plans required for the City of Camarillo Conditional Use Permit for the expanded, shared parking lot on the Eston Street side is now ready for District approval.

BACKGROUND

kidSTREAM was founded in 2016 as a 501(c)3 nonprofit organization. kidSTREAM's mission is to provide an engaging environment where kids explore, play, and discover with a vision to inspire and empower kids to become critical thinkers, innovators, and lifelong learners. They first operated without a building and delivered programming on sites of partner organizations, focused on STREAM: science, technology, reading, engineering, art, and math. The District has been partnering with kidSTREAM since 2018 on various projects, including securing the grand marshals for the 2019 Christmas Parade (astronauts) and Halloween and Eggstravaganza in subsequent years.

In June 2018, the City of Camarillo unanimously approved a term sheet and rental agreement for kidSTREAM to take over the former library site to build an educational and regional children's museum. In December 2019, the City extended its agreement with kidSTREAM through April 2022. On March 24, 2021, the City approved the donation of the site rather than a sale. The grant deed states that the property will be a children's museum unless otherwise agreed in writing by the

City, which is recorded with the Ventura County Recorder's Office. The City acknowledges that the proposed use of the Property as a museum is consistent with the current General Plan and zoning ordinances subject to the approval of a Conditional Use Permit by the City Planning Commission.

In preparation for the Conditional Use Permit process, the District Board approved and authorized the General Manager on February 3, 2022, to submit a letter to the City of Camarillo authorizing kidSTREAM to submit a Conditional Use Permit application. As required, kidSTREAM applied for the Conditional Use Permit (CUP - 412) in line with the CEQA process. Upon review of CUP-412, the City determined that the current designated parking spaces did not provide sufficient space for kidSTREAM.

To address this, a shared Parking, Access, and Maintenance Agreement was approved by the District Board in November of 2022. Additional conditions include: a) the wall located along the westerly side of the parking lot expansion be submitted for review and approval by the City of Camarillo Community Development Director and District General Manager, and 2) the parties will enter into a separate agreement for the expansion and construction for expanding the parking lot.

AGREEMENT

The Parking, Access, and Maintenance Agreement provides shared use of the parking spaces on the District property located on the northeastern portion of Bob Kildee Community Park, as shown on Attachment "1" and is known as Accessor Parcel Number 166-0-020-32.

ANALYSIS

kidSTREAM has submitted design plans for the parking lot expansion (Attachment 3), which Staff has reviewed as a requirement for District approval and sign-off. A list of minor changes has been provided to kidSTREAM's architectural team for incorporation into the final plan. In accordance with the City's conditions for permit issuance, District approval is necessary.

Staff's required amendments to the plan are as follows:

- Change the retaining wall finish from a stucco to a slump block.
- Galvanized fencing to specify that it is fabricated then hot-dipped galvanized rather than welding pre-galvanized tubing.
- Revise the landscape tree selection in the parking lot tree wells from the California Sycamore to Geijera parviflora/Australian Willow.
- Revise the planting plan to eliminate the Magnolia "Little Gems" with a suitable replacement.

Staff is seeking the Board's consideration and approval of the plans for the parking expansion, granting the General Manager the authority to accept the plans of the kidSTREAM parking lot expansion with staff's recommended amendments.

FISCAL IMPACT

There is no fiscal impact associated with this action.

STRATEGIC PLAN COMPLIANCE

Meets 2021-2026 Strategic Plan Goal

- 4.4: Enhance community connections by fostering collaborative partnerships that leverage strengths and resources to enrich the recreation experience.

RECOMMENDATION

It is recommended that the Board approve the proposed design and construction plans for the kidSTREAM expanded parking lot on the Eston Street side at Bob Kildee Community Park.

ATTACHMENTS

- 1) Parking Agreement (14 pages)
- 2) Department of Community Development Conditions of Approval (6 pages)
- 3) kidSTREAM Landscape Design (19 pages)

MEMORANDUM OF UNDERSTANDING BETWEEN THE PLEASANT VALLEY RECREATION AND PARK DISTRICT AND KIDSTREAM REGARDING THE SHARED USE OF THE DRIVEWAY AND PARKING LOCATED AT BOB KILDEE PARK

This Memorandum of Understanding (“Agreement”) regarding the shared parking and use of a driveway is entered into on this 17 day of, Nov. 2022, by and between, the Pleasant Valley Recreation & Park District (“District”) located at 1605 Burnley Street, Camarillo, CA 93010 and kidSTREAM Children’s Museum, a California non-profit corporation (“kidSTREAM”), located at 3100 Ponderosa Drive, Camarillo, CA 93010. The District and kidSTREAM are collectively referred to here as the “Parties”.

RECITALS

A. District owns and operates a portion of the parking lot and adjacent park (Bob Kildee Park) located at 1030 Temple Avenue in the City of Camarillo, County of Ventura, State of California, which is also known as Assessor Parcel Numbers 166-0-020-315, 166-0-020-325, 166-0-020-200 (“District Parcel”) which is depicted on Exhibit “A”, attached hereto and incorporated herein since 1969.

B. On February 3, 2022, the District Board approved and authorized the General Manager to submit a letter to the City of Camarillo authorizing kidSTREAM to submit a Conditional Use Permit application.

C. kidSTREAM desires to share the use of the parking lot located on the District Parcel shown in Exhibit “B” to provide additional parking for the kidSTREAM Property (“kidSTREAM Property”). The kidSTREAM Property is located at 3100 Ponderosa Drive in the City of Camarillo, County of Ventura, State of California, which is also known as Assessor’s Parcel Number 166-0-020-315 and is depicted on the map attached as Exhibit “A”.

D. The District desires to accommodate kidSTREAM’s desire to share the use of the parking spaces on the District Parcel located on the northeastern portion of property as well as to provide ingress and egress through the parking lot entrance within the District Parcel shown on Exhibit “D” (“Shared Parking Area”) on the terms described herein.

NOW, THEREFORE, the District declares, covenants and agrees, by and for itself, its heirs, executors and assigns, and all persons claiming under or through it that the Shared Parking Area may be used and occupied by kidSTREAM’s officers, visitors, staff, and invitees (“kidSTREAM Parties”) subject to the restrictions hereinafter set forth, which restrictions are established for the benefit of for the use of visitors to the kidSTREAM Property.

TERMS AND CONDITIONS

1. Grant for Shared Parking and Driveway Access. Subject to the limitations set forth in Section 9 below, District hereby grants kidSTREAM and KidSTREAM's Parties a non-exclusive right to access and use of the Shared Parking Area to park vehicles in connection with the use of the kidSTREAM Property, including the right of ingress and egress within the District Parcel, during the hours listed below, to provide parking for the kidSTREAM Property. kidSTREAM Parties may access the Shared Parking Area:

- Tuesday through Saturday 10:00 am until 5:00 pm
- Sundays 12:00 pm – 5:00 pm
- Holidays and special event hours will be communicated and approved by the District.

2. Term.

A. Initial Term. This Agreement shall commence on the date executed by both parties for a term of years (5) years from the date that the last party signs the Agreement ("Term"). However, kidSTREAM may not commence its use of the Shared Parking Area until the District has received and approved of kidSTREAM's proof of all required insurance.

B. Extension of Term. Provided that kidSTREAM is not in default of any of the terms and conditions of this Agreement, the Parties may agree (but are not obligated) to extend the term of this Agreement for successive five (5) year increments, or any shorter period of time, on mutually satisfactory terms, if kidSTREAM gives the District written notice of its request to renew at least one-hundred eighty (180) days before expiration of the then-current term.

C. Termination. At any time either the District or KidSTREAM with or without cause may terminate this Agreement and such termination shall be effective following 30 days' notice by either party.

3. Non-Exclusive Use.

The right to use the Shared Parking Area is non-exclusive, and the District hereby reserves and retains the right to make any permitted use of the Shared Parking Area, to the extent that the permitted use does not interfere with the rights granted to kidSTREAM under this agreement.

Notwithstanding the forgoing, the District will not enter into other agreements for the right to use any portion of the Shared Parking Area with any other organizations, entities, individuals, or parties so long as kidSTREAM abides by the Terms set forth in this Agreement and this Agreement remains in full force and effect.

4. Improvements to Benefit the Shared Parking Area. In anticipation of kidSTREAM's use of the parking spaces within the District Parcel and the impacts that

will result on the Shared Parking Area, kidSTREAM has agreed to fund capital repairs and make certain improvements on the District Parcel as described below.

A. Maintenance and Repair. The obligation for maintenance and repair of the Shared Parking Area shall be undertaken by the District; however, KidSTREAM will financially contribute 40% of the cost, approximately every 5 to 7 years for any Capital Repair/Replacement work performed on the Shared Parking Area by the District. In addition, on a daily basis as needed, kidSTREAM is responsible for the removal of trash and debris from the parking areas within the District Parcel that is left by kidSTREAM's Parties. KidSTREAM shall also be responsible for all costs to repair and replace any of the improvements on the District Parcel that are needed as a result of damages caused by buses and/or large vehicles serving kidSTREAM or any kidSTREAM Parties.

B. Expansion. kidSTREAM shall be solely responsible for the cost to expand the parking lot to meet the future needs of kidSTREAM's use of the site, which correlates with a phased construction of the building as described in Exhibit "C" which provides the anticipated timeline and scope of work for phased construction of kidSTREAM as well as expansion of ancillary parking (collectively "kidSTREAM Improvements") in Exhibit "D". The parties will enter into a separate agreement for the expansion and construction of the expanded parking lot. The following items will determine the timeline for the parking expansion. The kidSTREAM Improvements will be undertaken in compliance with all applicable laws.

o **Parking Lot Expansion Timeline**

- o The anticipated timeline for kidSTREAM Phase II construction which includes the parking lot expansion, is between 6-12 months from the Grand Opening of kidSTREAM, following the completion of Phase I construction.
- o During the plan check process for kidSTREAM Phase I construction, kidSTREAM will be required to submit a phasing plan supported by a parking study that demonstrates that at each phase, sufficient parking is provided, which will be submitted for review and approval by the Director of Community Development and the City Traffic Engineer prior to issuance of a Zone Clearance or grading permit.
- o If the project is determined to have insufficient parking during the plan check process for Phase I construction, kidSTREAM will include the construction of the parking lot expansion, in Phase I construction.
- o If kidSTREAM raises adequate funding to build the parking lot expansion during the plan check process for Phase I construction, kidSTREAM will include the parking lot expansion in Phase I construction.

5. Permitted Use. District and any successor, tenant, or assignee of District shall use or permit the use of the parking spaces within the Shared Parking Area by

kidSTREAM and kidSTREAM Parties for the purposes stated in Section 1 hereof. Such permitted use shall be subject to the restriction that kidSTREAM's use of the District Parcel will not conflict with District's principal operating hours and uses. District's principal operating hours for the District Parcel are sunrise to sunset Sunday – Saturday. The parking areas within the Shared Parking Area shall at all times be maintained and kept clear, unobstructed and overnight parking (with the exception of any organizationally owned kidSTREAM vehicles or prearranged kidSTREAM overnight programming parking) shall be prohibited. Other than a closure resulting from an emergency, the District shall provide kidSTREAM with no less than four (4) business days' notice of any temporary closure of the Shared Parking Area that could restrict access to parking spaces within the Shared Parking Area.

6. Insurance. Prior to kidSTREAM's commencement of the use of the Shared Parking Area and during the entire Term of this Agreement, kidSTREAM shall provide District with proof of the types and amounts of insurance required by Exhibit "E". The District may amend Exhibit "E" upon 30 days' notice to the person described in Section 11 in the event industry standards require changes in the types or amounts of insurance.

7. Indemnity. kidSTREAM shall indemnify, protect, defend, and hold harmless the District and its officers, agents, and employees from and against any and all claims, damages, and liabilities resulting from any actual or alleged accident, injury, loss or damage to any person or property arising in connection of the use of the Shared Parking Area by kidSTREAM's Parties. KidSTREAM shall not be liable or required to indemnify District from and against any claims, damages, or liabilities arising from or in connection with the use of the Shared Parking Area by District or its officers, employees, guests and invitees resulting from District's negligence, including the failure to properly maintain the Shared Parking Area or adjacent areas owned by District, or District's willful misconduct.

District shall indemnify, protect, defend, and hold harmless kidSTREAM and kidSTREAM Parties from and against any and all claims, damages and liabilities resulting from any actual or alleged accident, injury, loss or damage to any person or property arising in connection of the use of the Shared Parking Area by District's employees, guests and invitees. District shall not be liable or required to indemnify kidSTREAM or kidSTREAM Parties from and against any claims, damages, or liabilities arising from or in connection with the use of the Shared Parking Area by kidSTREAM or kidSTREAM Parties or resulting from kidSTREAM or kidSTREAM Parties' negligence or willful misconduct.

8. Transfer and Assignment. The parties hereto may not assign, transfer, convey or delegate any of their rights and duties with respect to the Shared Park Area or otherwise under this Agreement. Any attempted assignment of the Shared Parking Area or the rights and duties of the parties under this Agreement, without the amendment of this Agreement by the Parties, whether voluntary or involuntary or by operation of law, shall be void and of no effect. Nothing contained in this Agreement does or shall be construed to limit in any way the right and ability of the parties to transfer, sell or

encumber their respective properties.

9. Recitals Incorporated. The recitals set forth above are incorporated herein as if set forth in full.

10. Miscellaneous Provisions.

(a) kidSTREAM is owner of land depicted on Exhibit "A" and made a part hereof by reference. kidSTREAM grants the District utilization of its parking spaces for use of parking for automobiles of employees, or members of the general public using the park.

(b) No change, amendment, alteration, or revision of this Agreement shall be valid unless evidenced by a written agreement approved and executed by both District and kidSTREAM.

(c) District represents that as of the effective date hereof, it is the sole owner of the District Parcel and that it has the authority to enter into this Agreement and that, once authorized and in effect, this Agreement is a valid and binding obligation of District.

(d) In the event the kidSTREAM Property ceases to be used as a Children's Museum, this Agreement shall automatically terminate.

11. Notices. All notices and other communications given pursuant to this Agreement shall be in writing and shall be deemed properly served if delivered in person to the party to whom it is addressed or three (3) days after mailing, if mailed by first class mail. For purposes of notice, the address of the parties shall be as follows:

District: Pleasant Valley Recreation & Park District
1605 E. Burnley Street
Camarillo, CA 93010
Attn: Mary Otten
Phone: 805-482-1996

kidSTREAM: kidSTREAM
3100 Ponderosa Drive
Camarillo, CA 93010

Attn: Michael Shanklin
Phone: 805-419-3545

IN WITNESS WHEREOF, the undersigned have executed this Agreement was executed as of the date first written above.

"kidSTREAM":
kidSTREAM Children's Museum

By: 
Name:
Title:

By: Kristen Akl
Name: Board Chair
Title:

"District":
PLEASANT VALLEY RECREATION &
PARK DISTRICT

By: 
Chair

ATTEST:

Clerk of the Board

EXHIBIT "A"

OVERVIEW AND APN OF PROPERTIES



EXHIBIT "B"

**AERIAL VIEW OF DISTRICT & KIDSTREAM
LOCATION**



ASSESSOR PARCEL NUMBER:

A. 166-0-020-325

B. 166-0-020-420

C. 166-0-020-200

Bob Kildee Park

1030 Temple Ave/Ponderosa Drive
Community Park

PLEASANT VALLEY PARK & RECREATION DISTRICT



EXHIBIT "C"

kidSTREAM's PROJECTED EXPANSION OF THE PARKING LOT TIMELINE



EXHIBIT "D"

PROJECTED EXPANSION OF THE PARKING & DETAILS



EXHIBIT “D”

PROJECTED EXPANSION OF THE PARKING & DETAILS

Project Parking Information

- kidSTREAM onsite parking – 31 stalls
- PVRPD onsite parking – 57 stalls (included in shared parking agreement)
- kidSTREAM Phase II Construction, parking lot expansion – 21 stalls
- Total onsite parking – 109 stalls (including kidSTREAM onsite parking, PVRPD onsite parking, shared parking agreement, kidSTREAM Phase II Construction)
- Advanced Transportation Engineers project parking demand – 101 stalls (Parking Section, pages 18 – 20, 04_kidSTREAM TRAFFIC_PARKING STUDY Rev. 3)

Construction Details

- kidSTREAM is proposing to expand the existing parking lot on PVRPD property to include 21 new parking stalls
- kidSTREAM will provide a galvanized steel fence along the westerly side of the parking lot expansion, which will be submitted for review and approval by the Community Development Director and PVRPD General Manager
- Proposed parking lot expansion is roughly estimated to have a three (3) month duration

EXHIBIT "E"

**PLEASANT VALLEY RECREATION & PARK DISTRICT
INSURANCE REQUIREMENTS**

KidSTREAM shall procure and maintain for the duration of the Agreement (and thereafter as specified herein) insurance against claims for injuries to persons or damage to property which may arise from or in connection with the performance of the work hereunder by kidSTREAM, its agents, representatives, employees or subcontractors.

MINIMUM SCOPE OF INSURANCE

Coverage shall be at least as broad as:

1. Insurance Services Office Commercial General Liability coverage (occurrence form CG 00 01).
2. Insurance Services Office form number CA 00 01 covering Automobile Liability, Code 1 (any auto).
3. Workers' Compensation insurance as required by the State of California and Employer's Liability Insurance.

MINIMUM LIMITS OF INSURANCE

KidSTREAM shall maintain limits no less than:

1. General Liability (Including operations, products and completed operations, as applicable): \$2,000,000 per occurrence for bodily injury, personal injury and property damage. If Commercial General Liability Insurance or other form with a general aggregate limit is used, either the general aggregate limit shall apply separately to this project/location or the general aggregate limit shall be twice the required occurrence limit.
2. Automobile Liability: \$1,000,000 per accident for bodily injury and property damage.
3. Employer's Liability: \$1,000,000 per accident for bodily injury or disease.

DEDUCTIBLES AND SELF-INSURED RETENTION

Any deductibles or self-insured retentions must be declared to and approved by the District. At the option of the District, either (1) the insurer shall reduce or eliminate such deductibles or self-insured retentions as respects the District and its directors, officers, employees, agents and volunteers (collectively "District Parties"), or (2) kidSTREAM shall provide a financial guarantee satisfactory to the District guaranteeing payment of losses and related investigations, claim administration and defense expenses.

OTHER INSURANCE PROVISIONS`

The commercial general liability and automobile liability policies are to contain, or be endorsed to contain, the following provisions:

1. The District and District Parties are to be covered as insured's as respects: liability arising out of work or operations performed by or on behalf of kidSTREAM; or automobiles owned, leased, hired or borrowed by kidSTREAM.
2. For any claims related to this Agreement, kidSTREAM insurance coverage shall be primary insurance as respects the District and District Parties. Any insurance or self-insurance maintained by the District and District Parties shall be excess of the kidSTREAM insurance and shall not contribute with it.
3. Each insurance policy required by this clause shall be endorsed to state that coverage shall not be canceled by either party, except after thirty (30) day's prior written notice has been provided to the District.

ACCEPTABILITY OF INSURERS

Insurance is to be placed with insurers with a current A.M. Best's rating of no less than A: VII, unless otherwise acceptable to the District. Exception may be made for the State Compensation Insurance Fund when not specifically rated.

VERIFICATION OF COVERAGE

KidSTREAM shall furnish the District with original certificates and amendatory endorsements effecting coverage required by this clause. The endorsements should be on forms provided by the District, or on other than the District's forms provided those endorsements conform to District requirements and are acceptable to the District. All certificates and endorsements are to be received and approved by the District before work

commences. However, failure to do so shall not operate as a waiver of these insurance requirements. The District reserves the right to require complete, certified copies of all required insurance policies, including endorsements affecting the coverage required by these specifications at any time.

DEPARTMENT OF COMMUNITY DEVELOPMENT

CONDITIONS OF APPROVAL

CUP 412, KidSTREAM

FIRE PROTECTION

1. Building Plan Review - Building plans of all A, E, I, H, R-1, R-2 or R-4 occupancies shall be submitted, with payment for plan check, to the Fire District for review and approval prior to obtaining a building permit.

POLICE

2. A six-foot (6') high chain link fence with solid colored mesh must be erected around the site during the construction of the exterior areas.
3. Construction equipment, tools, etc. will be properly secured during non-working hours.
4. If an alarm system is used, it should be wired to all exterior doors and windows and to any roof vents or other roof openings where access may be made.

AIR QUALITY

5. The development must meet all regulations of the Ventura County Air Pollution Control District and must be in compliance with the Air Quality Management Plan (AQMP).

LANDSCAPING

6. That a detailed landscaping, irrigation plan, and specifications prepared by a registered Architect or by a registered Landscape Architect must be submitted for all green areas, or public or semi-public areas, including required street trees. Said landscaping must include an automatic irrigation system with moisture sensors and automatic rain shut-off devices and consist of a combination of trees, shrubs, and groundcover utilizing drought-resistant materials with careful consideration given to eventual size, spread, susceptibility to disease and pests, and durability and adaptability to existing soil and climatic conditions. Plans must also include a program for maintenance. The landscaping of the development must be completed and maintained in accordance with the landscape plans submitted and approved by the City Landscape Architect consultant and the Director of Community Development.
7. Landscaping and irrigation must be in compliance with the City's Landscape and Irrigation Guidelines and Chapter 14.14 – Water Efficient Landscapes of the Camarillo Municipal Code.
8. The developer must submit a landscape irrigation audit report to the Department of Community Development in compliance with the State Model Water Efficient Landscape Ordinance prior to occupancy.

9. The landscaping of the development must be completed and maintained in accordance with the landscape plans submitted and approved by the City Landscape Architect consultant and the Director of Community Development.
10. All planting area must be filled to within two inches (2") of the top of curbs. Planting areas must be cleared of debris, rocks, concrete, and other foreign material preparatory to planting. The Department of Community Development must approve curb design adjacent to planters and no asphalt or concrete must extend into planters.
11. Landscape plans must be at a minimum scale of 1" = 20'; except that slope planting plans may be at 1" = 30' minimum scale.
12. That any tree within five feet (5') of any public sidewalk, or other public improvement, must be provided with a root barrier as approved by the Assistant Director Public Works/City Engineer and Director of Community Development.
13. That *prior* to final inspection, the Developer must submit *written certification* from the Landscape Architect that the landscaping has been completed in accordance with the approved plans and specifications.
14. All landscape plan check and inspection fees must be paid at the time of submittal of landscape plan.
15. Driveways and parking areas must be separated from landscape areas by means of concrete curbing a minimum of six inches (6") above the parking area.
16. All trees are to be double staked per City Standard S-2 or appropriately supported, as approved by the Director of Community Development.
17. Planting fingers must be five feet (5') minimum in width and must be provided where required by Ordinance.
18. That where a parking space's vehicle overhang extends a maximum of two feet (2') into an adjacent planter area, the planter area must remain level within that area.

RECYCLING/REFUSE

19. That the user submit a recycling plan illustrating the programs that will be employed by the individual use.
20. In addition to the usual trash receptacles, that space be provided in the trash enclosure for the storage of containers for recycling and organic waste; or a separate enclosure must be provided depending on the amount of recyclable and organic waste material.
21. During construction, the developer must divert 65 percent of all non-hazardous construction materials from landfill (CalGreen Building Code Part II of Title 24 California Code of Regulations. Recycling bins must be made available during construction and labeled "Recycling Only," or bins containing mixed material must be sent to a State-approved recycling center or transfer station where the material is to be sorted for proper recycling.

Prior to issuance of a building permit, the developer must submit a Construction and Demolition Materials Management Plan Estimate to the Building and Safety Division for recycling of waste materials consistent with the aforementioned requirement. The

Construction and Demolition Materials Management Plan Estimate must include estimated quantities for each type of material to be diverted or landfilled.

Prior to final inspection, the developer must submit a Final Report Construction and Demolition Waste Letter of Documentation to the Building and Safety Division, demonstrating compliance with the Construction and Demolition Materials Management Plan Estimate and indicate the total amount of construction and demolition waste diverted.

22. Development must include post-consumer recycled materials in the construction of the project with a minimum of five percent (5%) of the total estimated project cost--excluding land costs and grading costs and government fees to be used as the guide. *Prior* to zone clearance, the Developer must submit a list of material to be used and an indication of the total percentage of the construction cost. Prior to final inspection, the Developer must submit written certification describing compliance with this condition.
23. Trash enclosures of a matching masonry material, as used in the building, must be provided with solid-screen gates with overhead trellis and solid roof. Said trash enclosures must be of sufficient size to accommodate the needs of the users and must be constructed in accordance with the Standard Plate S-1, or approved alternate design, to screen the storage of refuse. In addition to the area for trash receptacles, space must be provided for storage/collection of recyclables and organic waste, or a separate enclosure must be provided, to accommodate the amount of recyclable or organic waste material.
24. Trash enclosures must include a lattice structure to cover the enclosure with a solid roof design below to direct stormwater away from entering the enclosure itself. All litter/waste material must be kept in leak-proof containers. The area must be paved with impermeable material. No other area must drain onto these areas. The trash enclosure area must not be designed nor constructed with a drain that is connected directly to the storm drain system or the sanitary sewer.

NOISE

25. Site preparation and construction activities must be limited to between the hours of 7 a.m. and 7 p.m., and *not* on Sundays or holidays, in accordance with the City's Noise Ordinance.

WATER AND ENERGY CONSERVATION

26. Developer must comply with any water conservation requirements established by Ordinance or otherwise that are in effect at the time of application for building permit.
27. Water conservation devices must be installed in the project, including without limitation ultra-low consumption toilets and flow restrictors, in accordance with Camarillo Municipal Code, Chapter 14.12.

SPECIAL

28. **A parking, access, and maintenance agreement must be executed and remain in effect between kidSTREAM and Pleasant Valley Recreation and Park District (PVRPD) for the**

expansion of the parking lot on PVRPD property for use by kidSTREAM and must be subject to the approval of the Director of Community Development and the City Attorney.

29. A phasing plan supported by a parking study that demonstrates that at each phase, sufficient parking is provided must be submitted for review and approval by the Director of Community Development and City Traffic Engineer prior to issuance of a Zone Clearance or grading permit, whichever occurs first.
30. That an outdoor art feature be provided no later than the completion of phase 2, subject to review and approval by the Planning Commission prior to fabrication and installation of the artwork.
31. That the wall located along the westerly side of the parking lot expansion be submitted for review and approval by the Community Development Director and PVRPD General Manager prior to issuance of a grading permit.

AGREEMENT FOR TRANSFER AND DEVELOPMENT

32. The project is subject to the terms of the Agreement for the Transfer and Development of Real Property.
33. The Applicant must enter escrow and close escrow in accordance with the terms of the Agreement for the Transfer and Development of Real Property.

GENERAL

34. That the applicant must obtain appropriate permits and a zone clearance must be obtained from the City Departments of Community Development, Public Works/Land Development Division, and Building and Safety. Additional information and fees may be required from these departments, including such fees as: school, traffic, soils reports, geologic studies, grading plans, utilities, encroachment permit, and building code requirements. The building plans will also be coordinated with other governmental agencies (i.e., fire, water, environmental health, etc.). It is the applicant's responsibility to ensure that all City of Camarillo and interested parties' requirements have been met.
35. That the permit is granted for the land, as described in the application, and any attachment thereto, and shown on the plot plan and elevations submitted and labeled as Exhibit "A".
36. That the location of all buildings, fences, roadways, parking areas, landscape and other facilities or features must be substantially as shown on the plan labeled, Exhibit "A," and in conformance with the conditions labeled, Exhibit "B".
37. The applicant must sign and return an Applicant's Statement within 10 days of approval that he/she is aware and understands and agrees to abide and adhere to all conditions of approval attached to the project.
38. The development must be provided with bicycle racks in a location and of a suitable design, as approved by the Director of Community Development.
39. All parking spaces must meet City ordinance requirements with handicapped and compact car spaces being signed.

40. All exterior light fixtures and location be approved by the Director of Community Development. On-site lighting must be shielded and directed from adjoining properties, so as to produce no annoyance or nuisance or traffic hazard.
41. That a photometric lighting plan for the parking lot expansion be submitted for review and approval by the Director of Community Development prior to issuance of a grading permit.
42. That, if archaeological or historical artifacts are uncovered during land modification activities, the site must be preserved until a qualified Archaeologist is consulted for proper disposition of site and a concurrence received from the Department of Public Works/Engineering and the Department of Community Development.
43. That unless the use is inaugurated, or the construction of the structure is commenced and diligently pursued not later than twelve (12) months from the date this permit is granted, this permit will automatically expire on that date. However, if there have been no changes in the proposed plot plan or adjacent area, the Director of Community Development may grant additional time extensions for use inauguration.
44. That the final colors, textures, and materials be submitted for approval by the Director of Community Development prior to issuance of the zone clearance.
45. All exterior mechanical equipment, including roof mounted equipment must be shown on plans and screened by appropriately- designed treatment approved by the Director of Community Development.
46. No exterior access ladders of any kind to the roof are permitted.
47. The Director of Community Development may approve minor changes, but any substantial change must require the filing of a modification application to be considered by the Planning Commission.
48. Additions, changes, exterior modifications, rooftop equipment, storage, or equipment enclosures may be built only after receiving Department of Community Development approval and appropriate permits.
49. Parking areas must be developed and maintained in accordance with the requirements of the Camarillo Municipal Code. All parking spaces and loading areas must be striped and maintained so that it remains clearly visible during the life of the development.
50. Prior to any re-striping of the parking area, a zone clearance must be obtained. All disabled parking spaces and paths of travel must be re-striping and maintained in their original locations unless new locations are approved by the Director of Community Development.
51. All temporary and permanent signage must be submitted under a sign permit for review and approval by the Department of Community Development prior to issuance of a building permit. All signage must comply with the requirements of the Camarillo Municipal Code.
52. Applicant agrees, as a condition of issuing this permit, to pay all legal and expert fees and expenses of the City in defending any legal action brought against the City, other than one by the applicant, challenging the issuance of the permit, or any action or failure to act by the City relating to the environmental review process pursuant to the California Environmental Quality Act. In the event such a legal action is filed against the City, City must estimate its expenses for the litigation, and applicant must deposit said amount with the City, or enter into an agreement with the City, to pay such expenses, as they become due.

53. Developer, by acceptance of the approval of CUP-412, agrees to indemnify, defend, and hold the City harmless from and against any and all liabilities, claims, actions, causes of action, proceedings, suits, damages, judgments, liens, levies, costs, and expenses of whatever nature, including reasonable attorney fees and disbursements (collectively, "Claims"), which the City may suffer or incur, or to which the City may become subject by reason of, or arising out of, the City's approval of this project, or the activities undertaken by the Developer under this permit and any related project approvals. If any Claim is brought against the City by legal action or otherwise, Developer agrees to defend the City at the City's request and with counsel satisfactory to the City. For the purposes of this section, "City" includes the City of Camarillo's officials, officers, employees, and agents.
54. Developer/Applicant must reimburse the City for all attorneys' fees expended by the City, which are directly related to the processing of this development/project. No Certificate of Occupancy or other final occupancy approval must be given until the attorneys' fees billed to date have been paid.
55. There must be no outdoor storage, sales, or displays in accordance with the R-1 Zone.
56. The project must comply with the requirements of the R-1 Zone.
57. The owner of the property must regularly and promptly remove any and all graffiti from the project, must maintain exteriors in a clean and attractive condition, and must maintain all landscaping required for the project in a healthy, orderly, and aesthetically-pleasing condition. In instances where the Department of Community Development determines that a violation of this condition exists, the owner must act promptly to correct the condition, in accordance with the direction of the Director of Community Development.
58. All persons doing business in the City of Camarillo in connection with the project must have a current Business Tax Certificate prior to commencing construction.

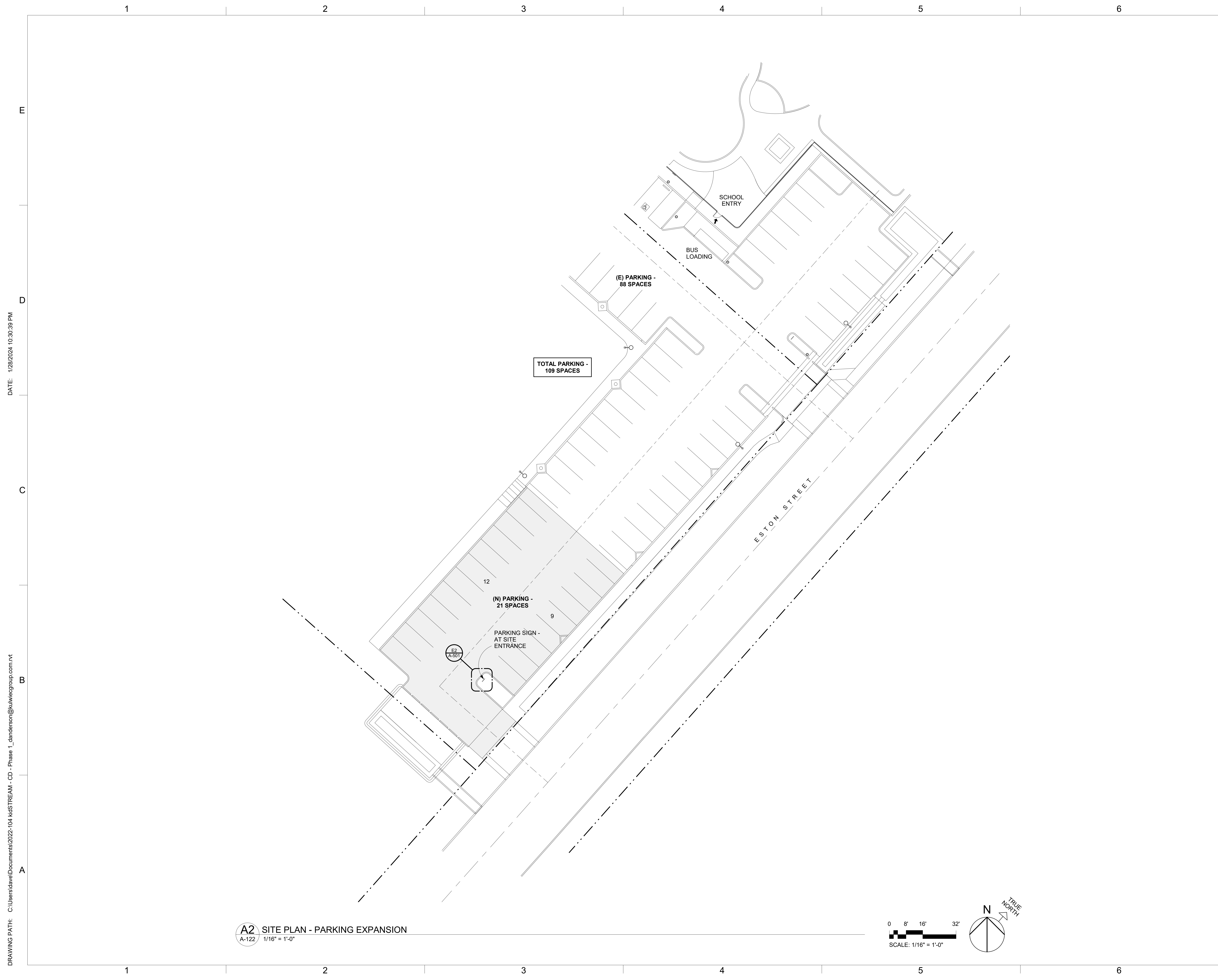

DATE: 1/28/2024 10:30:39 PM
DRAWING PATH: C:\Users\dave\Documents\2022-104 kidSTREAM - CD - Phase 1_anderson@kulwiecgroup.com.rvt

A2 SITE PLAN - PARKING EXPANSION
A-122 1/16" = 1'-0"

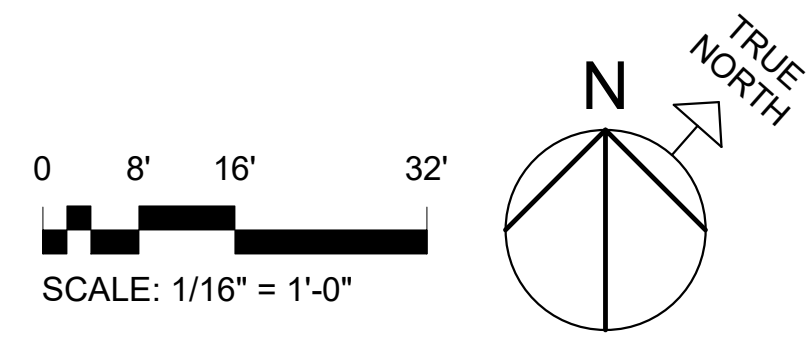

ANDERSON KULWIEC APPELBY ARCHITECTS

ARCHITECTURE
PLANNING
INTERIOR DESIGN

David Anderson A.I.A., Architect
Marilyn Appleby A.I.A., Architect
854 East Main Street, Suite 100
Santa Paula, California 93060
(805) 933-0225
(805) 933-6609 FAX



Consultants:

Architect's Project Number:
2022-104.1

Project:
kidSTREAM CHILDREN'S MUSEUM ADAPTIVE REUSE - PHASE ONE

3100 East Ponderosa Drive
Camarillo, California 93010

Owner:
kidSTREAM Children's Museum in Ventura County
3100 East Ponderosa Drive
Camarillo, California 93010

△	Date	Description
REVISIONS		

4	1-31-2024	Submit Plan Check
3	9-20-2023	90% CD
2	4-10-2023	Preliminary CD
1	2-17-2023	100% Design Development

Num	Date	Description
ISSUE RECORD		

COPYRIGHT 2024
THIS DOCUMENT AND THE IDEAS AND DESIGNS INCORPORATED HEREIN, AS INSTRUMENTS OF PROFESSIONAL SERVICE, ARE THE PROPERTY OF ANDERSON KULWIEC APPELBY ARCHITECTS AND ARE NOT TO BE USED, IN WHOLE OR IN PART, FOR ANY PROJECT WITHOUT THE WRITTEN AUTHORIZATION OF ANDERSON KULWIEC APPELBY ARCHITECTS.

Drawn by: _____ Author
Checked by: _____ Checker

CAD File Name: _____

Sheet Title:
SITE PLAN - PARKING EXPANSION

Date: **31 January 2024**
Sheet Number:

A-122

DRAWING PATH: C:\Users\dave\Documents\2022-104 kidSTREAM - DD_danderson@kulwiecgroup.com.rvt

DATE: 12/20/2022 12:14:37 PM

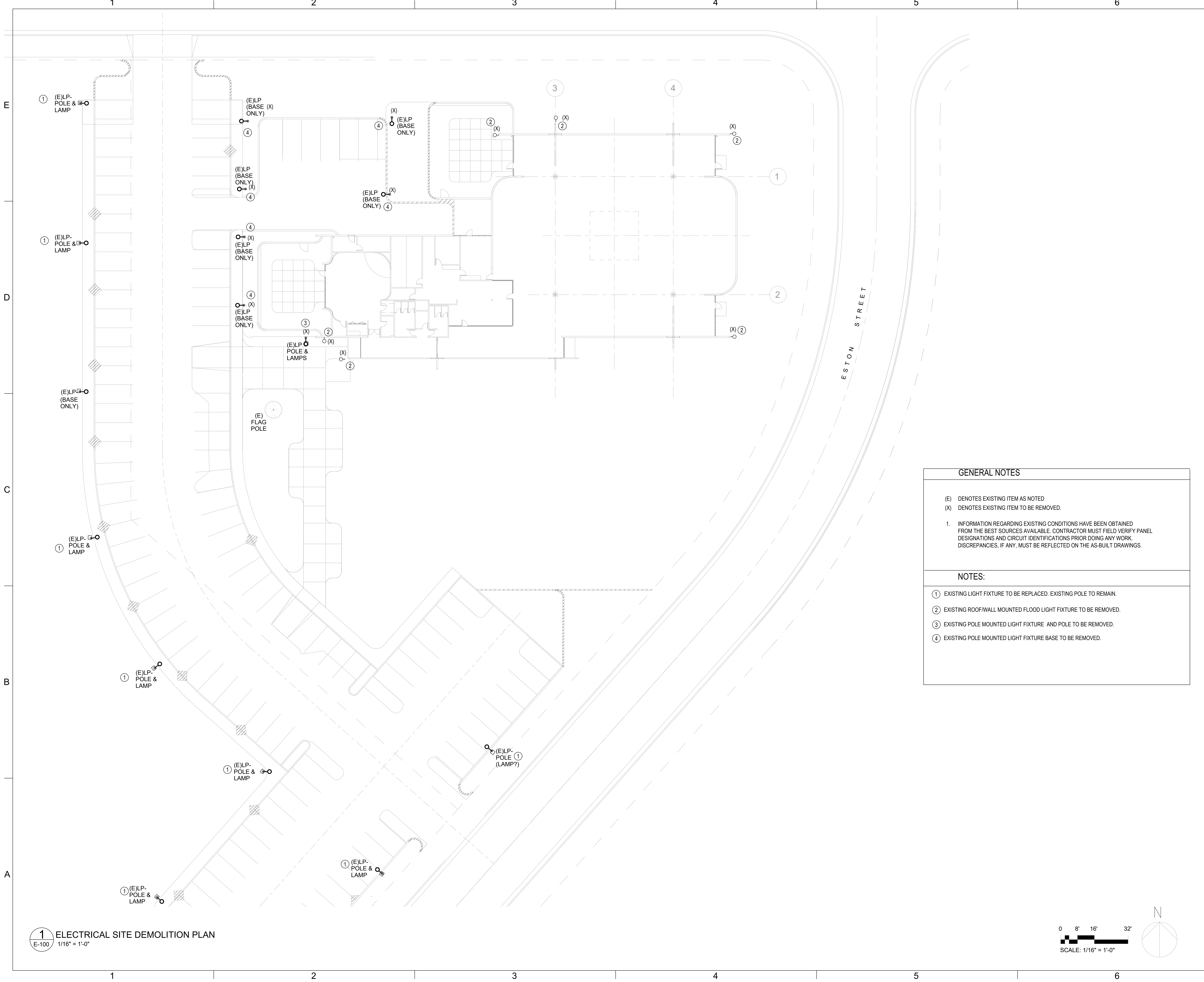

GENERAL NOTES

(E) DENOTES EXISTING ITEM AS NOTED
 (X) DENOTES EXISTING ITEM TO BE REMOVED.

1. INFORMATION REGARDING EXISTING CONDITIONS HAVE BEEN OBTAINED FROM THE BEST SOURCES AVAILABLE. CONTRACTOR MUST FIELD VERIFY PANEL DESIGNATIONS AND CIRCUIT IDENTIFICATIONS PRIOR DOING ANY WORK. DISCREPANCIES, IF ANY, MUST BE REFLECTED ON THE AS-BUILT DRAWINGS.

NOTES:

① EXISTING LIGHT FIXTURE TO BE REPLACED. EXISTING POLE TO REMAIN.
 ② EXISTING ROOF/WALL MOUNTED FLOOD LIGHT FIXTURE TO BE REMOVED.
 ③ EXISTING POLE MOUNTED LIGHT FIXTURE AND POLE TO BE REMOVED.
 ④ EXISTING POLE MOUNTED LIGHT FIXTURE BASE TO BE REMOVED.

1 ELECTRICAL SITE DEMOLITION PLAN
 E-100 1/16" = 1'-0"

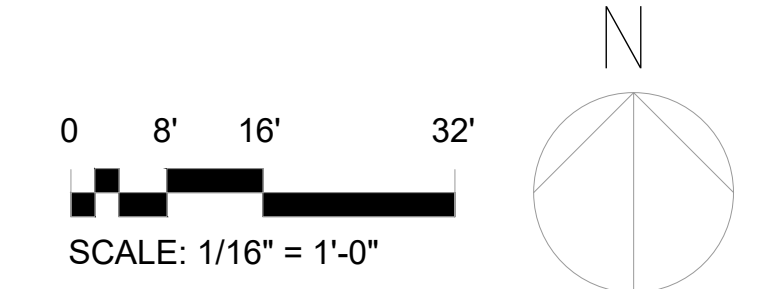

**ANDERSON
 KULWIEC
 APPELBY
 ARCHITECTS**

ARCHITECTURE
 PLANNING
 INTERIOR DESIGN

David Anderson A.I.A., Architect
 Marilyn Appleby A.I.A., Architect
 854 East Main Street, Suite 100
 Santa Paula, California 93060
 (805) 933-0225
 (805) 933-6609 FAX

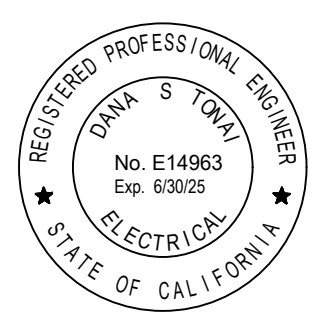

Consultants:

Parviz Ebrahimi, Inc.
 Consulting Electrical Engineers
 25101 THE OLD ROAD
 SANTA CLARITA, CALIFORNIA 91381
 tel.: (818) 991-7371
 email: peinc.info@earthlink.net

Architect's Project Number:
2022-104

Project:
**kidSTREAM
 CHILDREN'S MUSEUM
 ADAPTIVE REUSE -
 PHASE 1**

3100 East Ponderosa Drive
 Camarillo, California 93010

Owner:
kidSTREAM
 Children's Museum in
 Ventura County

3100 East Ponderosa Drive
 Camarillo, California 93010

Date	Description

Num	Date	Description
4	1-31-2024	Submit Plan Check
3	9-20-2023	90% CD
2	4-10-2023	Preliminary CD
1	2-17-2023	100% Design Development

ISSUE RECORD

COPYRIGHT 2022

THIS DOCUMENT AND THE IDEAS AND DESIGNS INCORPORATED HEREIN, AS INSTRUMENTS OF PROFESSIONAL SERVICE, ARE THE PROPERTY OF ANDERSON KULWIEC APPELBY ARCHITECTS AND ARE NOT TO BE USED, IN WHOLE OR IN PART, FOR ANY PROJECT WITHOUT THE WRITTEN AUTHORIZATION OF ANDERSON KULWIEC APPELBY ARCHITECTS.

Drawn by: _____ Author
 Checked by: _____ Checker

CAD File Name: _____

Sheet Title:
**ELECTRICAL
 SITE DEMO
 PLAN**

Date: **31 JANUARY 2024**

Sheet Number:
E-100

SUBMIT PLAN CHECK

DRAWING PATH:

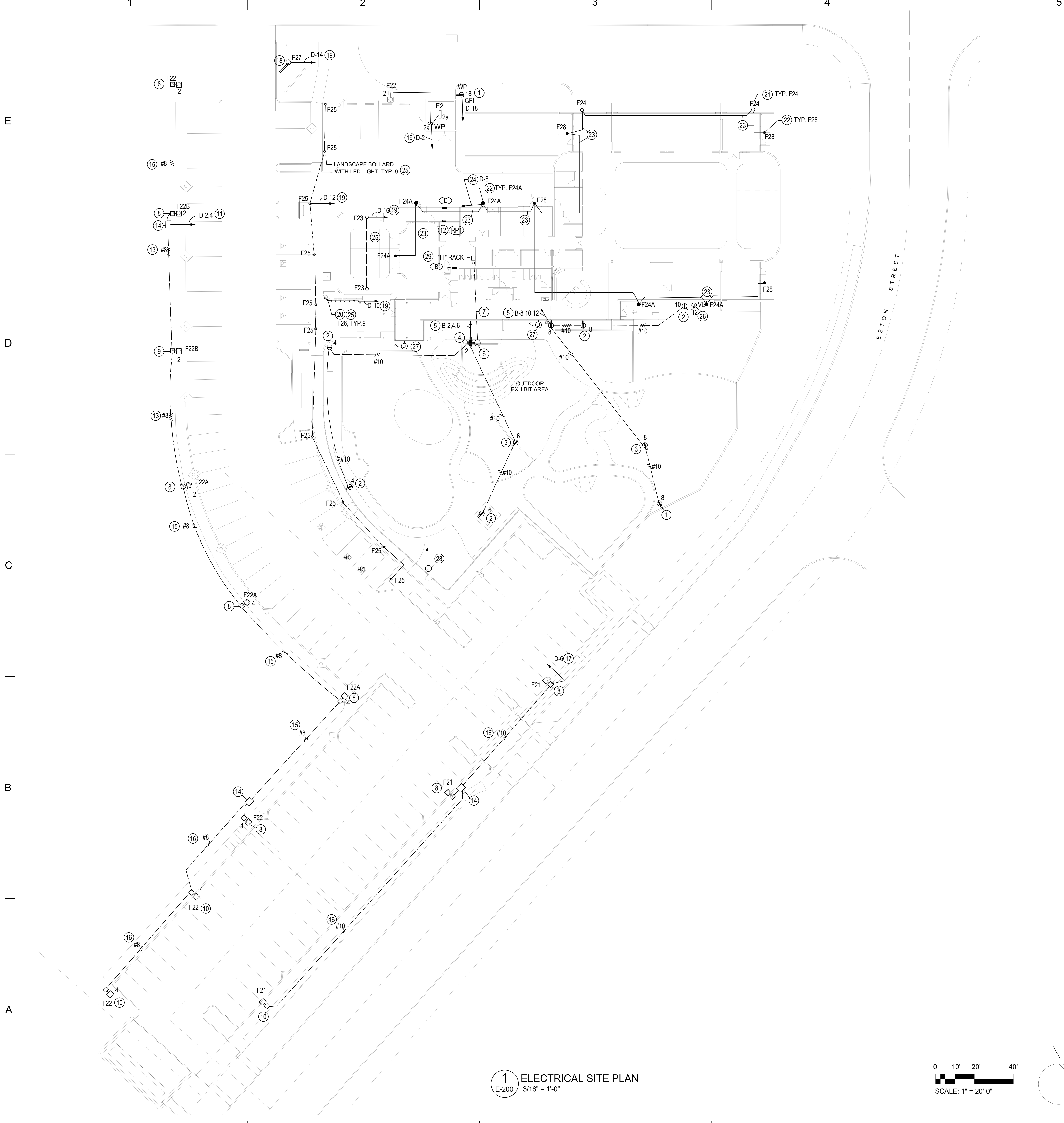

1 ELECTRICAL SITE PLAN
E-200
3/16" = 1'-0"

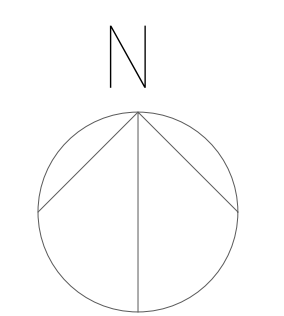
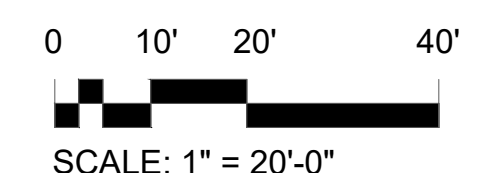

- GENERAL NOTES**
- (E) DENOTES EXISTING ITEM AS NOTED
 - CONDUITS MAY BE SHOWN OFFSET FOR DRAWING CLARITY.
 - ALL UNDERGROUND CONDUITS SHALL BE 24" BELOW GRADE MIN. (UON).
 - ALL EMPTY CONDUITS SHALL BE PROVIDED WITH PULLSTRING AND CAPPED WITH STANDARD CAP AND LABEL BOTH ENDS WITH THE LOCATION OF OTHER END.
 - USE 3/4"C AND #10/THWN-2 WIRES(MIN. SIZE) FOR SITE LIGHTING (UON).
 - PROVIDE CODE SIZED EQUIPMENT GROUND WIRE WITH ALL BRANCH CIRCUIT WIRING WHETHER OR NOT SHOWN ON THE DRAWINGS.
 - CONTRACTOR TO CONTACT DIG-ALERT ORGANIZATION PRIOR ANY UNDERGROUND INSTALLATION FOR LOCATING UNDERGROUND UTILITIES.
 - PROVIDE SEPARATE NEUTRAL FOR EACH BRANCH CIRCUIT. DO NOT SHARE NEUTRAL BETWEEN BRANCH CIRCUITS.
- NOTES:**
- 20A, 120V, GFCI WEATHER RESISTANT TAMPER RESISTANT DUPLEX RECEPTACLE WITH LOCKABLE WEATHERPROOF NON METALLIC EXTRA DUTY IN-USE COVER. MOUNT RECEPTACLES ON WALL AT +15" AFF.
 - SIMILAR TO NOTE #1 EXCEPT PROVIDE 19.5" LOW PROFILE ENCLOSURE ARLINGTON GARD-N-POST #GPD 19BR FOR RECEPTACLE MOUNTING IN PLANTER AREA.
 - SIMILAR TO NOTE #1 EXCEPT MOUNT RECEPTACLE IN FS BOX AND SUPPORT FROM PLAY STRUCTURE. VERIFY LOCATION PRIOR ROUGH-INS.
 - 20A, 120V, GFCI WEATHER RESISTANT, TAMPER RESISTANT DOUBLE DUPLEX RECEPTACLE WITH LOCKABLE NON METALLIC EXTRA DUTY WEATHERPROOF IN-USE COVER. MOUNT RECEPTACES IN 2 GANG FS BOX AND SUPPORT WITH UNISTRUT AT +15".
 - HOMERUN 1"C-6#10-1#10G TO PANEL.
 - 2 GANG FS BOX FOR LOW VOLTAGE DATA WIRING. PROVIDE DATA JACKS /FACEPLATES PER OWNER. PROVIDE EXTRA DUTY WEATHERPROOF NON-METALLIC IN-USE LOCKABLE COVER.
 - ROUTE 1"C.O. WITH PULLSTRING UNDERGROUND TO STORAGE ROOM 2 AND STUB-UP +24 NEAR "T" RACK (NOTE 29) LOCATION. LABEL BOTH ENDS WITH THE LOCATION OF OTHER END.
 - EXISTING POLE LIGHT FIXTURE ON 20' POLE. REPLACE EXISTING 400W METAL HALIDE FIXTURE WITH NEW LED POLE LIGHT FIXTURE AS SHOWN. POLE TO BE RE-USED. PROVIDE ALL RETRO-FIT MOUNTING HARDWARE AS REQUIRED. SEE FIXTURE SCHEDULE ON E-030 FOR FIXTURE INFO.
 - EXISTING POLE LIGHT BASE. PROVIDE NEW 20', 4" SQUARE POLE TO MATCH EXISTING AND NEW LED POLE LIGHT FIXTURE AS SHOWN. PROVIDE ALL RETROFIT MOUNTING HARDWARE FOR POLE AND FIXTURE AS REQUIRED. SEE FIXTURE SCHEDULE ON E020 FOR FIXTURE INFO.
 - NEW POLE MOUNTED LIGHT FIXTURE. PROVIDE NEW BASE AND LIGHT FIXTURE PER FIXTURE SCHEDULE. PROVIDE NEW 20' POLE TO MATCH EXISTING. SEE TYPICAL BASE DETAIL ON E300 FOR INFO.
 - HOMERUN 1"C-4#8 +1#8 G TO PANEL VIA LIGHTING CONTROL RELAY PANEL "RP" (NOTE #12).
 - LIGHTING CONTROL RELAY PANEL. SEE LIGHTING CONTROL SCHEMATIC DIAGRAM AND RELAY PANEL "RP1" SCHEDULE ON E-020.
 - PROVIDE 4#8-1#18G/THWN-2 CONDUCTORS IN EXISTING CONDUIT.
 - INTERCEPT EXISTING CONDUIT AND INSTALL NEW COMPOSITE YARD BOX ASSEMBLY PRODUCT OF HIGHLINE CAT #CH4132424 TO BE USED FOR SPLICE. MOUNT BOX UNDERGROUND FLUSH WITH GRADE AND SET ON 8" COMPACTED CRUSHED ROCK BASE WHICH SHALL EXTEND 6" ALL AROUND. INSTALL IN PLANTER AREA.
 - PROVIDE 2#8-1#8G/THWN-2 CONDUCTORS IN EXISTING CONDUIT.
 - PROVIDE 3/4"C- 2#8-1#18G/THWN-2 CONDUCTORS. ROUTE UNDERGROUND 24".
 - PROVIDE 3/4"C-2#10 -1#10 G TO PANEL VIA LIGHTING CONTROL RELAY PANEL "RP1". ROUTE UNDERGROUND 24".
 - PROVIDE WP JUNCTION BOX FOR CONNECTION TO SIGN LIGHTING. VL MOUNT LIGHT FIXTURE USING ALUMINUM JUNCTION BOX MOUNTING ACCESSORY (2 REQUIRED FOR EACH FIXTURE). JUNCTION BOX TO BE BOTTOM FED AND BOLTED TO 2" THICK CONCRETE FOOTING. CONTRACTOR TO ADJUST/AIM DURING THE HOURS OF DARKNESS TO THE SATISFACTION OF
 - UNDERGROUND 3/4"C-2#10-1#10G AND 2#14 (0-10V CONTROL WIRES) TO PANEL VIA LIGHTING CONTROL RELAY PANEL "RP1". SEE RELAY PANEL "RP1" SCHEDULE ON E-020 FOR INFO.
 - IN GRADE LIGHT FIXTURES TO ILLUMINATE THE LETTERING MONUMENT. LIGHT FIXTURES TO ALIGN WITH CENTER OF CORRESPONDING LETTER. CONTRACTOR TO ADJUST/AIM LIGHT FIXTURES TO THE SATISFACTION OF THE OWNER'S REPRESENTATIVE.
 - NEW WALL MOUNTED LIGHT FIXTURE WITH BACKBOX FOR SURFACE MOUNTING.VL.
 - SURFACE MOUNTED LIGHT FIXTURE WITH EMERGENCY BATTERY PACK. VL. PROVIDE UNSWITCHED HOT LEG FOR OPERATION OF EMERGENCY BATTERY PACK.
 - 1/2"C-3#12(UNSWITCHED LEG, SWITCHED HOT, NEUTRAL)+1#12G AND 2#14 (0-10V CONTROL WIRES).
 - 1/2"C-3#12(UNSWITCHED LEG, SWITCHED HOT, NEUTRAL)+1#12G AND 2#14 (0-10V CONTROL WIRES), TO PANEL VIA LIGHTING CONTROL RELAY PANEL "RP1"
 - ROUTE 3/4"C-2#12(SWITCHED HOT, NEUTRAL)-1#12G AND 2#14 (0-10V CONTROL WIRES) BETWEEN FIXTURES.
 - PROVIDE WEATHERPROOF JUNCTION BOX FOR IRRIGATION CONTROLLER. VL. PROVIDE ALL CONNECTIONS COMPLETE.
 - PROVIDE WEATHERPROOF JUNCTION BOX FOR CAT 6e CABLE TERMINATION. SURFACE MOUNT ON WALL AT +12". VL. EXTEND 3/4"C TO IT RACK (NOTE #29) IN EXISTING ROOM 2.
 - WEATHERPROOF JUNCTION BOX FOR DATA CONNECTION. PROVIDE 3/4"C.O FOR CAT 6e DATA CABLE TO "T" RACK IN EXISTING ROOM 2.
 - "T" RACK. VL.

ANDERSON KULWIEC APPELBY ARCHITECTS

ARCHITECTURE
PLANNING
INTERIOR DESIGN

David Anderson A.I.A., Architect
Marilyn Appleby A.I.A., Architect
854 East Main Street, Suite 100
Santa Paula, California 93060
(805) 933-0225
(805) 933-6609 FAX

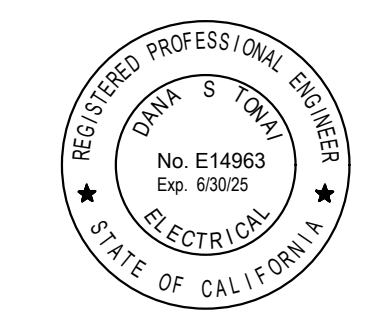

Consultants:

Parviz Ebrahimi, Inc.
Consulting Electrical Engineers
25101 THE OLD ROAD
SANTA CLARITA, CALIFORNIA 91381
tel.: (818) 991-7371
email: peinc.info@earthlink.net

Architect's Project Number:
2022-104

Project:
KidSTREAM CHILDREN'S MUSEUM ADAPTIVE REUSE - PHASE 1

3100 East Ponderosa Drive
Camarillo, California 93010

Owner:
kidSTREAM
Children's Museum in
Ventura County
3100 East Ponderosa Drive
Camarillo, California 93010

Date	Description

REVISIONS

Num	Date	Description
4	1-31-2024	Submit Plan Check
3	9-20-2023	90% CD
2	4-10-2023	Preliminary CD
1	2-17-2023	100% Design Development

ISSUE RECORD

COPYRIGHT 2022
THIS DOCUMENT AND THE IDEAS AND DESIGNS INCORPORATED HEREIN, AS INSTRUMENTS OF PROFESSIONAL SERVICE, ARE THE PROPERTY OF ANDERSON KULWIEC APPELBY ARCHITECTS AND ARE NOT TO BE USED, IN WHOLE OR IN PART, FOR ANY PROJECT WITHOUT THE WRITTEN AUTHORIZATION OF ANDERSON KULWIEC APPELBY ARCHITECTS.

Drawn by: DT
Checked by: DT
CAD File Name:
Sheet Title:

ELECTRICAL SITE PLAN

Date: 31 JANUARY 2024
Sheet Number:

E-200
SUBMIT PLAN CHECK

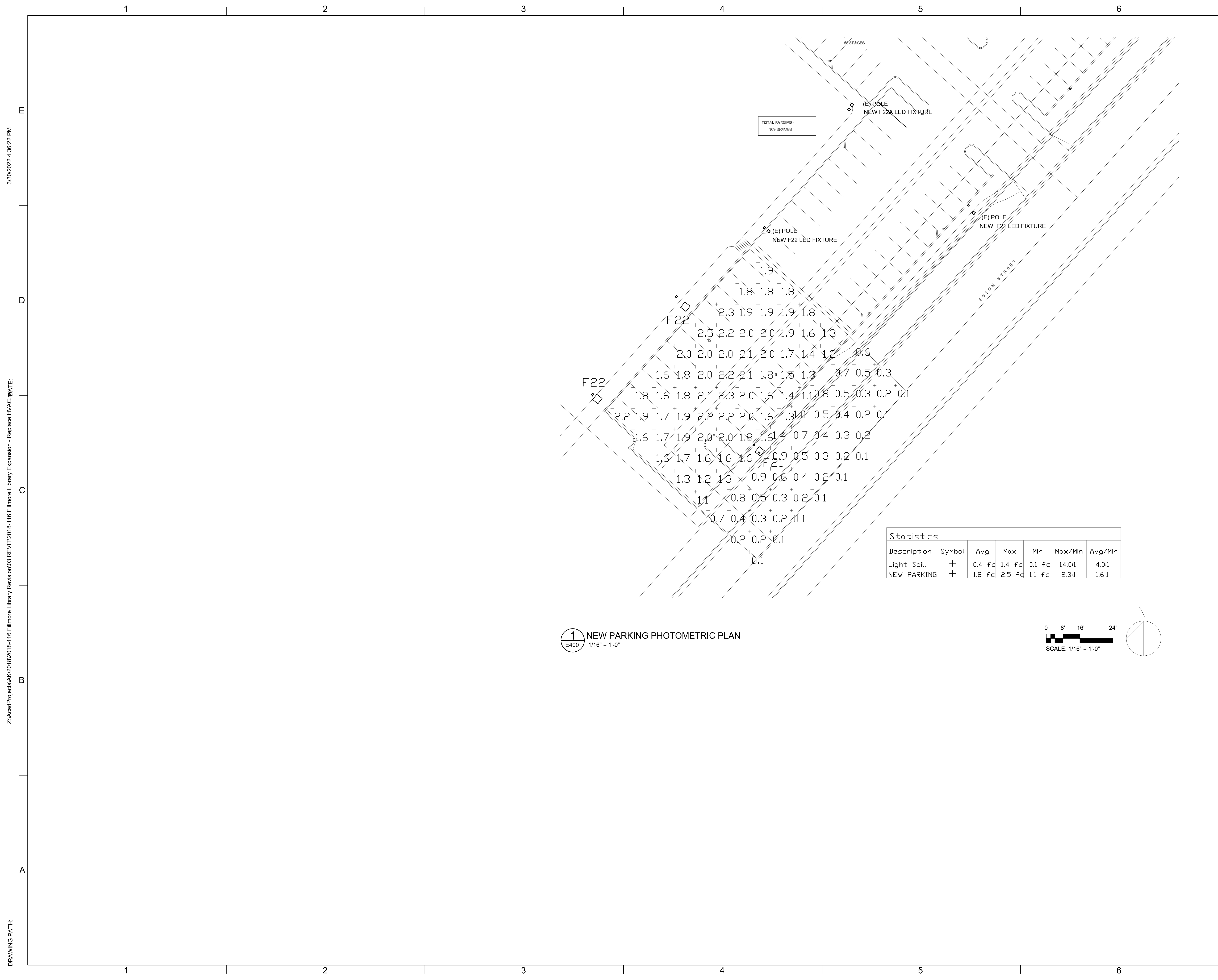

1 NEW PARKING PHOTOMETRIC PLAN
E400 1/16" = 1'-0"

Statistics						
Description	Symbol	Avg	Max	Min	Max/Min	Avg/Min
Light Spill	+	0.4 fc	1.4 fc	0.1 fc	14.0:1	4.0:1
NEW PARKING	+	1.8 fc	2.5 fc	1.1 fc	2.3:1	1.6:1

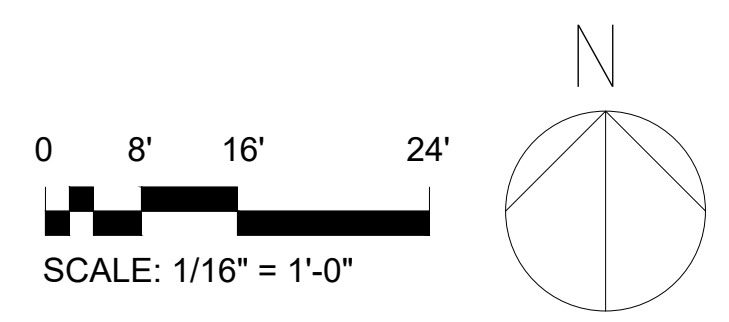

ANDERSON KULWIEC APPELBY ARCHITECTS

ARCHITECTURE
PLANNING
INTERIOR DESIGN
David Anderson A.I.A., Architect
Marilyn Appleby A.I.A., Architect
854 East Main Street, Suite 100
Santa Paula, California 93060
(805) 933-0225
(805) 933-6609 FAX

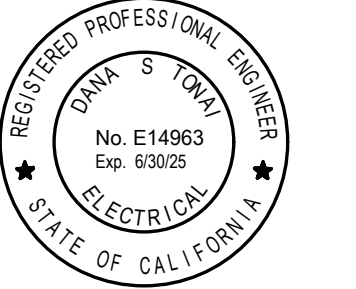

Consultants:

Parviz Ebrahimi, Inc.
Consulting Electrical Engineers
25101 THE OLD ROAD
SANTA CLARITA, CALIFORNIA 91381
tel.: (818) 991-7371
email: peinc.info@earthlink.net

Architect's Project Number:
2022-104

Project:
kidSTREAM CHILDREN'S MUSEUM ADAPTIVE REUSE - PHASE 1

3100 East Ponderosa Drive
Camarillo, California 93010

Owner:
kidSTREAM Children's Museum in Ventura County
3100 East Ponderosa Drive
Camarillo, California 93010

Date	Description

Num	Date	Description
4	1-31-2024	Submit Plan Check
3	9-20-2023	90% CD
2	4-10-2023	Preliminary CD
1	2-17-2023	100% Design Development

ISSUE RECORD

COPYRIGHT 2022
THIS DOCUMENT AND THE IDEAS AND DESIGNS INCORPORATED HEREIN, AS INSTRUMENTS OF PROFESSIONAL SERVICE, ARE THE PROPERTY OF ANDERSON KULWIEC APPELBY ARCHITECTS AND ARE NOT TO BE USED, IN WHOLE OR IN PART, FOR ANY PROJECT WITHOUT THE WRITTEN AUTHORIZATION OF ANDERSON KULWIEC APPELBY ARCHITECTS.

Drawn by: DT
Checked by: DT
CAD File Name:
Sheet Title:

NEW PARKING LOT PHOTOMETRICS

Date: 31 JANUARY 2024
Sheet Number:

E-400
SUBMIT PLAN CHECK

DRAWING PATH: Z:\AcadProjects\AK\2018\2018-116 Fillmore Library Revision\03 REV\112018-116 Fillmore Library Expansion - Replace HVAC.rvt DATE: 3/30/2022 4:36:22 PM

BY OTHERS SCHEDULE

ID#	ITEM	DESCRIPTION
O-1	BUS STOP	EXISTING TO REMAIN
O-2	OUTDOOR EXHIBIT SPACE	REFER TO PLANS PREPARED BY LANDREC/SITIO LANDSCAPE
O-3	PARKING LOT	SEE CIVIL PLANS
O-4	TRASH ENCLOSURE	REFER TO ARCHITECTS PLANS

CONSTRUCTION NOTES

- ALL PAVING AREAS SHALL BE GRADED NOT TO EXCEED 2% CROSS SLOPE IN ANY DIRECTION. WALKWAY RUNNING SLOPES SHALL NOT EXCEED 5% SLOPE UNLESS AN ADA RAMP IS PROVIDED. SEE CIVIL ENGINEERING GRADING PLANS FOR PRECISE GRADING OF ALL PAVING.
- BROOM FINISHES SHALL RUN PERPENDICULAR TO WALKS.
- CONSTRUCT 1/2" EXPANSION JOINTS W/FIBER JOINTS AND SEAL W/W.R. MEADOWS GREY DECK-O-SEAL.
- CONTRACTOR SHALL COORDINATE INSTALLATION OF ELECTRICAL CONDUIT, IRRIGATION PIPE, AND UTILITY BOXES TO AVOID CONFLICTS WITH FOOTING, DRAINAGE AREAS, OR INSTALLATION OF AMENITIES SUCH AS BOLLARDS, BOULDERS, BENCHES, AND ROOF DRAINS.
- FINISH GRADE IN PLANTER AREAS IS 3" BELOW ADJACENT FINISH SURFACE. TYPICAL.
- LAYOUT OF FORMS SHALL BE INSPECTED AND APPROVED BY THE LANDSCAPE ARCHITECT OF RECORD 24 HOURS PRIOR TO POURING. INSPECTION PRIOR TO FORM CONSTRUCTION IS PREFERRED.
- PRESERVE AND PROTECT ALL TREES THAT ARE TO REMAIN. DAMAGED TREES ARE TO BE REPLACED IN KIND AND SIZE BY CONTRACTOR. SEE TREE REMOVAL AND TREE PRESERVATION PLANS FOR MORE DETAIL.
- ALL MANUFACTURER SPECIFIED ITEMS TO BE PROVIDED AS SPECIFIED OR AN APPROVED EQUAL.

WALL AND FENCE SCHEDULE

ID#	ITEM	DESCRIPTION	DETAIL
W-1	ENTRY WALL	CMU BLOCK WALL WITH SMOOTH STUCCO FINISH AND 3 COURSES BREEZE BLOCK. COLOR TO MATCH ARCHITECTURE.	B/LC-2.02
W-2	WROUGHT IRON GATE	5'-0" HT. BLACK WROUGHT IRON GATE	C/LC-2.02
W-3	RETAINING WALL W/ GALV. FENCE	RETAINING WALL WITH GALVANIZED STEEL FENCE ATOP. HEIGHT OF WALL/FENCE VARIES DUE TO SLOPE.	A/LC-2.02

PAVING SCHEDULE

ID#	ITEM	DESCRIPTION	DETAIL
P-1	PEDESTRIAN PAVING	NATURAL GRAY CONCRETE WITH HEAVY BROOM FINISH PERPENDICULAR TO WALKWAY. SAWCUT CONTROL JOINTS. ADD FELT EXPANSION JOINTS AT 30' O.C. MAX. AT KEY INTERSECTIONS, AND WHERE CONCRETE MEETS STRUCTURAL FOOTINGS.	A&B/LC-2.01
P-2	OUTDOOR EXHIBIT PAVING- VEHICULAR	INTEGRALLY COLORED CONCRETE WITH HEAVY BROOM FINISH PERPENDICULAR TO WALKWAY. SAWCUT CONTROL JOINTS. SECTION PER CIVIL ENGINEER AND GEOTECHNICAL REPORT. DAVIS COLOR GRAPHITE '8084'	C/LC-2.01
P-3	PRIMARY ENTRANCE PAVING	24"x48" & 24"x24" PRIMA MATERIA' 10 mm PORCELAIN STONEWARE PAVING TILES. COLOR: CEMENTO & SANDALO. FINISH: GRIP. PATTERN: PER PLAN	D/DD-2.4
P-4	DETECTABLE WARNING SURFACE- PAVERS	ACKERSTONE 'PALAZZO 12x12 TRUNCATED DOMES' WARNING PAVER. COLOR: ONYX FM PTD-610. PATTERN: LINEAR IN STRAIGHT APPLICATIONS, RADIAL IN CURVED APPLICATIONS. AVAILABLE FROM ACKERSTONE (951)-674-0047 www.ackerstone.com	G/LC-2.01
P-5	FIRST RESPONDERS STRIPING	INSTALL 6" CENTER YELLOW DOUBLE NO PASSING ZONE DETAIL 21 PER CALTRANS STD PLAN A20A (THERMOPLASTIC). INSTALL 6" WHITE EDGE LINE DETAIL 27B PER CALTRANS STD PLAN A20B.	N/A
P-6	EXISTING SIDEWALK	TO REMAIN. REFER TO CIVIL PLANS	N/A
P-7	ALUMINUM HEADER	ALUMINUM HEADER, PERMALOC OR EQ.	I/LC-2.01

AMENITIES SCHEDULE

ID#	ITEM	DESCRIPTION	DETAIL
A-1	ADA ACCESSIBLE TREE GRATE	48"x48" SQUARE. IRONSMITH ELEMENT 100% RECYCLED GRAY IRON TREE GRATE (#48GELEMSQ) WITH 1/4" MAXIMUM SLOT OPENINGS MEET ADA COMPLIANCE WITH 18" TREE OPENING AND IRONSMITH FULL SQUARE TREE GRATE FRAME (#4800F). FINISH PER DETAIL	F/LC-2.01
A-2	BIKE RACK	DERO ROLLING RACK RR2H: 5 BIKE RACK. IN-GROUND MOUNT, POWDERCOAT FINISH. COLOR: TBD	PER MANUF.
A-3	ENTRY MONUMENT	10"x8"x16" PRECISION CMU BLOCK WALL MONUMENT WITH SMOOTH STUCCO FINISH. 11.4" TESSELLE 'SHAMROCK WHITE' CEMENT BREEZE BLOCK INSERT AND CUSTOM BRANDED, PAINTED ALUMINUM. PIN-SET LETTERING BY IMAGEFACTOR SIGN MFR.	A/LC-2.03
A-4	SECONDARY SIGNAGE	'BUS PARKING' DIRECTIONAL WAYFINDING METAL SIGNAGE ON GALV. POST	H/LC-2.01
A-5	BISTRO TABLES & CHAIRS	TO BE PROVIDED BY OWNER	N/A
A-6	BOLLARD LIGHTING	FORMS + SURFACES LIGHT COLUMN BOLLARD. 360 DEGREE SHIELD IN 'SCALE' PATTERN. 600 SERIES. FINISH: STAINLESS STEEL W/ SATIN FINISH. SURFACE MOUNT WITH J-BOLTS PER MFR. RECOMMENDATIONS. REFER TO ELECTRICAL ENGINEER'S PLANS FOR LAMP AND DRIVER SPECIFICATIONS.	PER MANUF.
A-7	BENCH	6'-0" BENCH WITH RECYCLED TEAK HARDWOOD SLATS AND POWDERCOATED FRAME & LEGS. FORMS + SURFACES CIRCUIT BENCH, SBCLR72T. COLOR: TBD	PER MANUF.
A-8	25' FLAG POLE	LIBERTY FLAG POLE COMPANY 25' TAPERED ALUMINUM FLAGPOLE WITH EXTERNAL HALYARD. MODEL ECA25. FINISH: ANODIZED CLEAR. AVAILABLE FROM LIBERTY FLAG POLE COMPANY, 800-314-2392 www.libertyflagpoles.com	E/LC-2.01
A-9	CUSTOM LETTERING SIGNAGE	CUSTOM FREESTANDING MOLDED ALUMINUM. PAINTED LOGO LETTERING ON CONCRETE PLINTH. LETTERING BY IMAGEFACTOR SIGN MFR.	B/LC-2.03
A-10	SAFETY BOLLARD	FORMS + SURFACES LIGHT COLUMN NON-ILLUMINATED BOLLARD. NO SHIELD. 600 SERIES WITH EMBEDDED SECURITY CORE. FINISH: STAINLESS STEEL W/ SATIN FINISH.	PER MANUF.
A-11	SAFETY & LIGHTING BOLLARD	FORMS + SURFACES LIGHT COLUMN BOLLARD. 360 DEGREE SHIELD IN 'SCALE' PATTERN. 600 SERIES. FINISH: STAINLESS STEEL W/ SATIN FINISH. EMBEDDED SECURITY CORE PER MFR. RECOMMENDATIONS. REFER TO ELECTRICAL ENGINEER'S PLANS FOR LAMP AND DRIVER SPECIFICATIONS.	PER MANUF.
A-12	DECORATIVE BARRIER	CUSTOM 1-1/2" GALVANIZED STEEL. POWDERCOATED BARRIER. IMBED MOUNT. COLOR: TBD.	D/LC-2.02

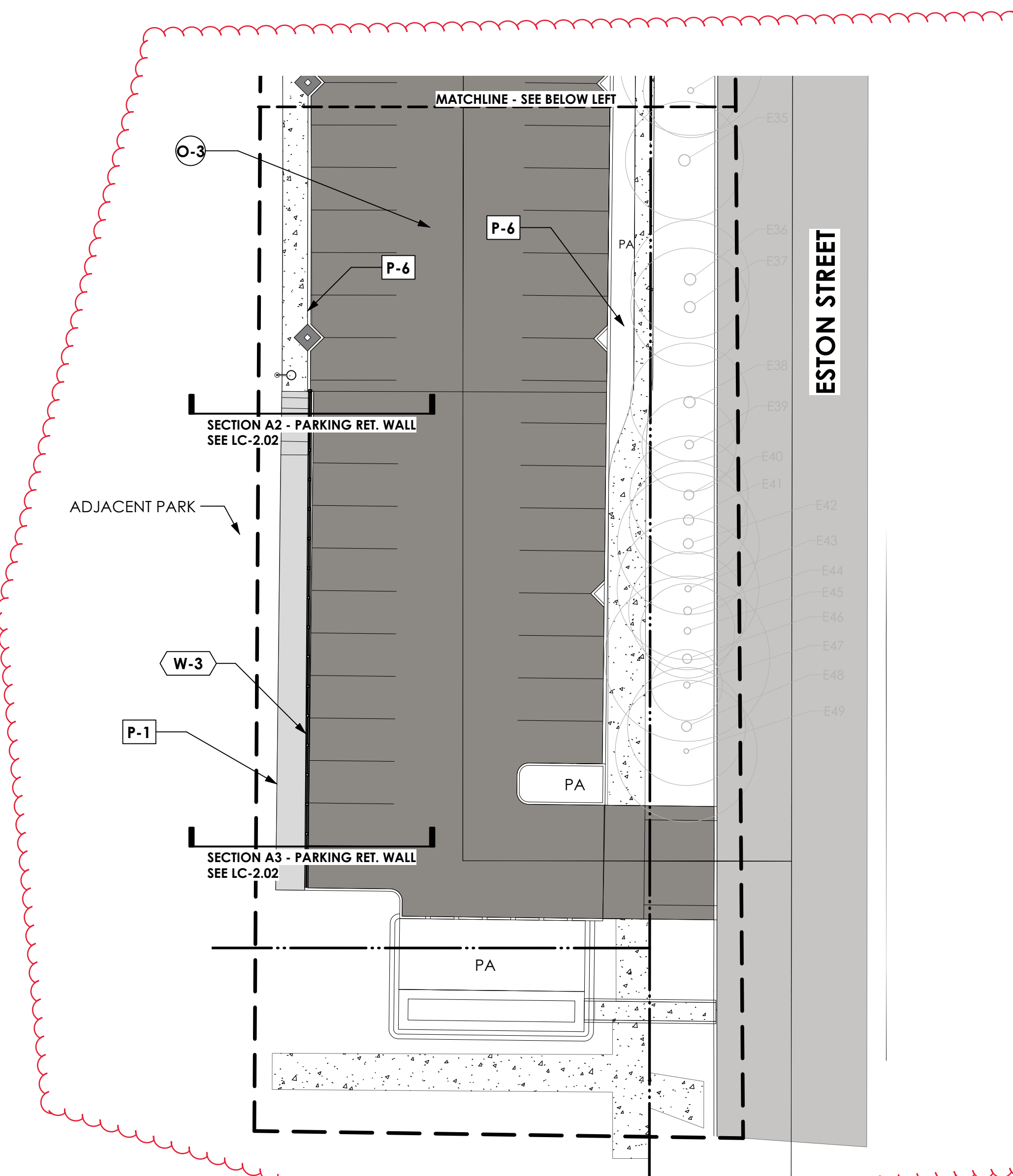
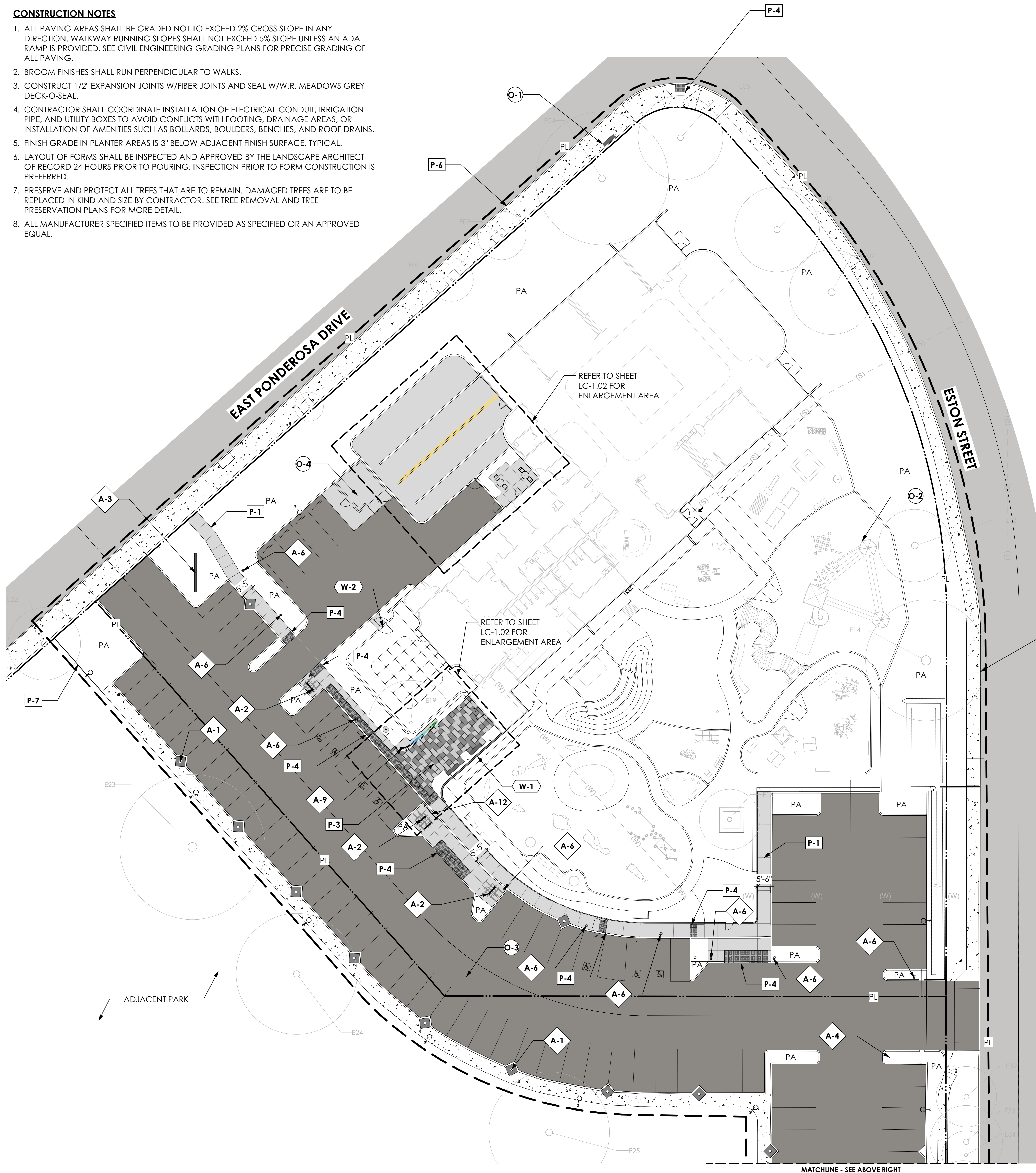

ANDERSON KULWIEC APPELBY ARCHITECTS

ARCHITECTURE
PLANNING
INTERIOR DESIGN

David Anderson A.I.A., Architect
Marilyn Appley A.I.A., Architect
854 East Main Street, Suite 100
Santa Paula, California 93060
(805) 933-0225
(805) 933-6609 FAX

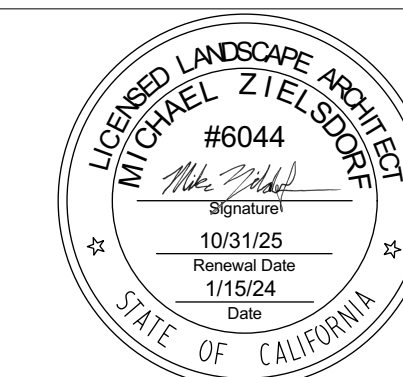

Consultants:



461 Main Street
Ventura, California 93001
(805) 644-9697

Architect's Project Number:
2022-104

Project:

kidSTREAM CHILDREN'S MUSEUM ADAPTIVE REUSE

3100 East Ponderosa Drive
Camarillo, California 93010

Owner:

kidSTREAM
Children's Museum in
Ventura County

3100 East Ponderosa Drive
Camarillo, California 93010

Date	Description
REVISIONS	

Num	Date	Description
ISSUE RECORD		

COPYRIGHT 2022
THIS DOCUMENT AND THE IDEAS AND DESIGNS INCORPORATED HEREIN, AS INSTRUMENTS OF PROFESSIONAL SERVICE, ARE THE PROPERTY OF ANDERSON KULWIEC APPELBY ARCHITECTS AND ARE NOT TO BE USED, IN WHOLE OR IN PART, FOR ANY PROJECT WITHOUT THE WRITTEN AUTHORIZATION OF ANDERSON KULWIEC APPELBY ARCHITECTS.

Drawn by:
Checked by:
CAD File Name: 21-011_L-Project.lwx

Sheet Title:
CONSTRUCTION & AMENITIES PLAN

Date: 3/18/2024
Sheet Number:

LC-1.01
CONSTRUCTION DOCUMENT

1

2

3

4

5

6

PLANTING NOTES

- ALL PLANTED AREAS SHALL BE THOROUGHLY RIPPED TO A DEPTH OF 8", USING RIPPER WITH TEETH NO WIDER THAN 12" O.C. WHERE POSSIBLE. THE RIPPING SHOULD BE DONE IN TWO DIRECTIONS TO REDUCE THE COMPACTION WHICH OCCURS AS A RESULT OF CONSTRUCTION.
- THE CONTRACTOR SHALL COLLECT A MINIMUM OF TWO SOIL SAMPLES FROM NEW PLANTING AREAS FOR AGRONOMIC TESTING & AMENDMENT RECOMMENDATIONS FROM FRUIT GROWERS LAB @ (805) 392-2000. RESULTS SHALL BE TRANSMITTED TO CLIENT AND LANDSCAPE ARCHITECT OF RECORD. SOIL MANAGEMENT REPORT RECOMMENDATIONS SHALL ADDRESS THE FOLLOWING AT A MINIMUM: SOIL TEXTURE, SOIL INFILTRATION RATE, SOIL PH, AND SUGGESTED AMENDMENTS BASED UPON PROPOSED PLANTING PALETTE. SEE SPECIFICATIONS.
- FOR SOILS LESS THAN 6% ORGANIC MATTER IN THE TOP 6 INCHES OF SOIL, COMPOST AT A RATE OF A MINIMUM OF FOUR CUBIC YARDS PER 1,000 SQUARE FEET OR PERMEABLE AREA SHALL BE INCORPORATED TO A DEPTH OF SIX INCHES INTO THE SOIL.
- ALL AMENDMENTS TO BE APPLIED PER SOIL MANAGEMENT REPORT, OR IF NO TECHNIQUE IS SPECIFIED, THEN MIXED TOGETHER AND ROTOTILLED INTO PLANTING AREAS TO A DEPTH OF 6". (UNTIL RESULTS OF SOIL MANAGEMENT REPORT ARE OBTAINED, THE FOLLOWING AMENDMENTS MAY BE USED FOR BID PURPOSES ONLY. RESULTS OF SOILS ANALYSIS SUPERSEDE THESE QUANTITIES):
 - 5 LBS/1000 SF POTASSIUM SULFATE
 - 5 LBS/1000 SF AMMONIUM SULFATE
 - 5 LBS/1000 SF SINGLE SUPERPHOSPHATE OR EQ.
 - 80 LBS/1000 SF AGRICULTURAL GYPSUM
 - 6 CY GENERAL PURPOSE SOIL AMENDMENT
- BACKFILL PER CY FOR CONTAINER PLANTS (BACKFILL MIX PROVIDED FOR BID PURPOSES ONLY. RESULTS OF SOILS ANALYSIS SUPERSEDE THESE QUANTITIES):
 - 1/4 LB POTASSIUM SULPHATE
 - 1/4 LB AMMONIUM SULPHATE
 - 1/5 LB SINGLE SUPERPHOSPHATE OR EQ.
 - 4 LBS AGRICULTURAL GYPSUM
 - 5 PARTS BY VOLUME NATIVE SOIL
 - 1 PART BY VOLUME AQUINAGA TURF PLUG
- GRO-POWER PLANTING TABLETS PLACED 2 INCHES DEEP AND 2" OUTSIDE ROOT BALL: (3) PER 1 GAL; (9) PER 5 GAL; (15) PER 15 GAL; (24) PER 24" BOX AND (24) PER 36" BOX.
- ALL TREES WITHIN 5 FT. OF PAVEMENT TO HAVE CENTURY PRODUCTS LINEAR CP36-2 'POLYETHYLENE' ROOT BARRIERS INSTALLED PER MANUFACTURER'S RECOMMENDATIONS 1 1/2" OFF BACK OF CURB OR EDGE OF PAVEMENT. ROOT BARRIER TO BE INSTALLED AT BACK OF HARDSCAPE, IN 10 FOOT PANELS CENTERED ON THE TREE TRUNK. (NOT IN CIRCLE AROUND ROOT BALL).
- PLANT MATERIAL QUANTITIES LISTED FOR CONVENIENCE OF CONTRACTOR. ACTUAL NUMBER OF SYMBOLS SHALL HAVE PRIORITY OVER QUANTITY DESIGNATED.
- A MINIMUM 3-INCH LAYER OF MULCH SHALL BE APPLIED ON ALL EXPOSED SOIL SURFACES OF PLANTING AREAS EXCEPT TURF AREAS, CREEPING OR ROOTING GROUNDCOVERS, OR DIRECT SEEDING APPLICATIONS WHERE MULCH IS CONTRADICTIONARY.
- MULCH SHALL BE ES-2 MULCH FROM AGROMIN PREMIUM SOIL PRODUCTS (805) 482.8749. PROVIDE SAMPLE TO LANDSCAPE ARCHITECT OF RECORD FOR APPROVAL.
- SEE SHEET, LP-2.01 FOR ALL PLANTING DETAILS

PLANT SCHEDULE

SYMBOL	QTY	LATIN NAME	COMMON NAME	WUCOLS	SIZE
TREES					
	4	<i>Arbutus x 'Marina'</i>	Marina Strawberry Tree	L	24" Box
	4	<i>Cassia leptophylla</i>	Gold Medallion Tree	M	24" Box
	17	<i>Cercis occidentalis</i>	Western Redbud	L	24" Box
	4	<i>Lagerstroemia indica 'Natchez'</i>	Natchez Crape Myrtle	M	24" Box
	3	<i>Magnolia grandiflora 'Little Gem'</i>	Dwarf Southern Magnolia	M	24" Box
	1	<i>Pinus canariensis</i>	Canary Island Pine	L	24" Box
	5	<i>Pistacia chinensis</i>	Chinese Pistache	M	24" Box
	19	<i>Platanus racemosa</i>	California Sycamore	M	24" Box

PLANT SCHEDULE

SYMBOL	QTY	LATIN NAME	COMMON NAME	WUCOLS	SIZE
SHRUBS					
	39	<i>Agave 'Blue Flame'</i>	Blue Flame Agave	L	5 gal
	7	<i>Agave vilmoriniana</i>	Octopus Agave	L	5 gal
	35	<i>Aloe striata</i>	Coral Aloe	L	1 gal
	7	<i>Arctostaphylos 'Dr. Hurd'</i>	Dr. Hurd Manzanita	L	15 gal
	8	<i>Asparagus densiflorus 'Myers'</i>	Foxtail Fern	M	1 gal
	66	<i>Bouteloua gracilis 'Blonde Ambition'</i>	Blonde Ambition Ornamental Grass	L	1 gal
	41	<i>Ceanothus griseus horizontalis 'Yankee Point'</i>	Yankee Point California Lilac	L	1 gal
	22	<i>Crassula capitella 'Campfire'</i>	Campfire Crassula	L	1 gal
	16	<i>Crassula ovata 'Gollum'</i>	Gollum Jade	L	1 gal
	10	<i>Crassula perforata</i>	String of Buttons	L	1 gal
	43	<i>Dianella revoluta 'DR5000' P.P.# 17719</i>	Little Rev™ Flax Lily	L	1 gal
	27	<i>Dudleya brittonii</i>	Giant Chalk Dudleya	L	1 gal
	9	<i>Euonymus japonicus 'Green Spire'</i>	Green Spire Euonymus	M	15 gal
	1	<i>Garya elliptica</i>	Coast Silk Tassel	L	15 gal
	36	<i>Gaura lindheimeri</i>	White Gaura, Lindheimer's beeblossom	L	1 gal
	5	<i>Helictotrichon sempervirens</i>	Blue Oat Grass	M	1 gal
	8	<i>Kalanchoe luciae</i>	Paddle Plant	L	1 gal
	17	<i>Lavandula x intermedia 'Provence'</i>	Provence French Lavender	L	1 gal
	52	<i>Mimulus aurantiacus</i>	Monkeyflower	L	1 gal
	192	<i>Muhlenbergia capillaris</i>	Pink Muhly	L	5 gal
	34	<i>Muhlenbergia dubia</i>	Pine Muhly	L	5 gal
	224	<i>Muhlenbergia lindheimeri 'Autumn Glow'</i>	Autumn Glow™ Muhly	L	5 gal
	162	<i>Muhlenbergia rigens</i>	Deer Grass	L	5 gal
	44	<i>Myoporum parvifolium 'Putah Creek'</i>	Prostrate Myoporum	L	1 gal
	10	<i>Pelargonium tomentosum</i>	Peppermint-Scented Geranium	L	1 gal
	61	<i>Pittosporum crassifolium 'Compactum'</i>	Dwarf Karo	M	5 gal
	8	<i>Polystichum munitum</i>	Western Swordfern	M	1 gal
	85	<i>Rhaphiolepis umbellata 'Minor'</i>	Dwarf Yedda Hawthorn	L	5 gal
	8	<i>Romneya coulteri</i>	Matilija Poppy	L	15 gal
	10	<i>Rosmarinus officinalis 'Tuscan Blue'</i>	Tuscan Blue Rosemary	L	1 gal
	21	<i>Salvia greggii 'Alba'</i>	White Texas Sage	L	1 gal
	7	<i>Salvia leucantha</i>	Mexican Sage	L	1 gal
	11	<i>Sansevieria trifasciata 'Moonshine'</i>	Silver Snakeplant	L	1 gal
	21	<i>Senecio cylindricus</i>	Narrow Leaf Chalksticks	L	1 gal
	28	<i>Stachys byzantina</i>	Lamb's-ears	M	1 gal
	74	<i>Teucrium cossonii</i>	Majorcan Teucrium	L	1 gal
	22	<i>Verbena ilacina 'De La Mina'</i>	De La Mina Verbena	L	1 gal
	17	<i>Westringia fruticosa 'Morning Light'</i>	Morning Light Westringia	L	5 gal

PLANT SCHEDULE

SYMBOL	QTY	LATIN NAME	COMMON NAME	WUCOLS	SIZE	SPACING
VINES						
	6	<i>Distictis buccinataria</i>	Scarlet Trumpet Vine	M	15 gal	PER PLAN
	5	<i>Parthenocissus 'Hacienda Creeper'</i>	Rancho Viejo Creeper	M	15 gal	PER PLAN
GROUNDCOVERS AND TURF						
	289 SF	<i>Carex praegracilis</i>	California Field Sedge	L	1 Gal.	18" O.C.
	33 SF	<i>Echeveria 'Ruffles'</i>	NCN	L	1 Gal.	12" O.C.
	181 SF	<i>Erigeron karvinskianus</i>	Santa Barbara Daisy	L	1 Gal.	18" O.C.
	855 SF	<i>Senecio serpens</i>	Blue Chalk Sticks	L	from Flats	24" O.C.
	137 SF	<i>Thymus praecox arcticus</i>	Creeping Thyme	L	from Flats	12" O.C.
	619 SF	Biofiltration Mix	Available from S&S Seeds	M	Sod	N/A
		<i>Festuca rubra</i>	Molate Fescue	M		
		<i>Hordeum californicum</i>	California Barley	M		
		<i>Hordeum branchyantherum</i>	Meadow Barley	M		
		<i>Nasella pulchra</i>	Purple Needlegrass	M		

NOTE: CONTRACTOR SHALL PROVIDE 2 FLATS OF 4' POTS SUCCULENTS TO BE SELECTED AND PLACED BY LANDSCAPE ARCHITECT.

ANDERSON KULWIEC APPELBY ARCHITECTS

ARCHITECTURE PLANNING INTERIOR DESIGN
David Anderson A.I.A., Architect
Marilyn Appelby A.I.A., Architect
854 East Main Street, Suite 100
Santa Paula, California 93060
(805) 933-0225
(805) 933-6609 FAX

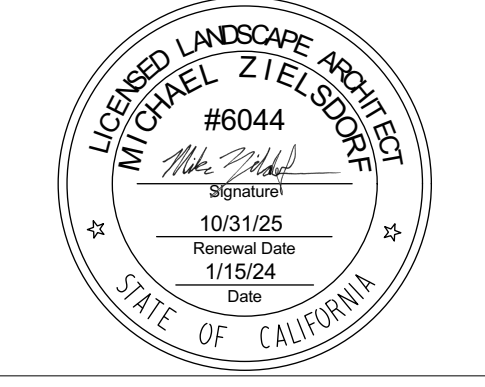

Consultants: Pacific Coast Land Design Inc.
Landscape Architecture • Urban Design • Environmental Planning
461 Main Street
Ventura, California 93001
(805) 644-9697

Architect's Project Number: 2022-104

kidSTREAM CHILDREN'S MUSEUM ADAPTIVE REUSE

3100 East Ponderosa Drive
Camarillo, California 93010

Owner: kidSTREAM Children's Museum in Ventura County
3100 East Ponderosa Drive
Camarillo, California 93010

Table with 2 columns: Date, Description. Header: REVISIONS

Table with 3 columns: Num, Date, Description. Header: ISSUE RECORD

COPYRIGHT 2022
THIS DOCUMENT AND THE IDEAS AND DESIGNS INCORPORATED HEREIN, AS INSTRUMENTS OF PROFESSIONAL SERVICE, ARE THE PROPERTY OF ANDERSON KULWIEC APPELBY ARCHITECTS AND ARE NOT TO BE USED, IN WHOLE OR IN PART, FOR ANY PROJECT WITHOUT THE WRITTEN AUTHORIZATION OF ANDERSON KULWIEC APPELBY ARCHITECTS.

Drawn by:
Checked by:

CAD File Name: 21-011_L-Project.lww

Sheet Title: PLANT SCHEDULE

Date: 1/15/2024

Sheet Number:

LP-0.01

CONSTRUCTION DOCUMENT

Date: Monday, January 15, 2024
Time: 9:54:01 AM
File name: P:\Pacific Coast Land Design, Inc\PROJECTS - Documents\21-011 KIDSTREAM MUSEUM\CAD\21-011_L-Project.lww

ANDERSON KULWIEC APPELBY ARCHITECTS

ARCHITECTURE
PLANNING
INTERIOR DESIGN
David Anderson A.I.A., Architect
Marilyn Appleby A.I.A., Architect
854 East Main Street, Suite 100
Santa Paula, California 93060
(805) 933-0225
(805) 933-6609 FAX

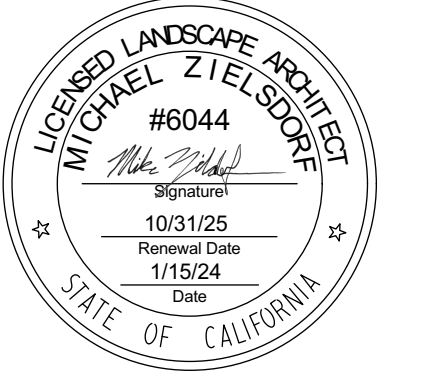

Consultants:
Pacific Coast Land Design Inc.
Landscape Architecture • Urban Design • Environmental Planning
461 Main Street
Ventura, California 93001
(805) 644-9697

Architect's Project Number:
2022-104
Project:
kidSTREAM CHILDREN'S MUSEUM ADAPTIVE REUSE

3100 East Ponderosa Drive
Camarillo, California 93010
Owner:
kidSTREAM Children's Museum in Ventura County
3100 East Ponderosa Drive
Camarillo, California 93010

Date	Description
REVISIONS	

Num	Date	Description
ISSUE RECORD		

COPYRIGHT 2022
THIS DOCUMENT AND THE IDEAS AND DESIGNS INCORPORATED HEREIN, AS INSTRUMENTS OF PROFESSIONAL SERVICE, ARE THE PROPERTY OF ANDERSON KULWIEC APPELBY ARCHITECTS AND ARE NOT TO BE USED, IN WHOLE OR IN PART, FOR ANY PROJECT WITHOUT THE WRITTEN AUTHORIZATION OF ANDERSON KULWIEC APPELBY ARCHITECTS.

Drawn by:
Checked by:
CAD File Name: 21-011_L-Project.vwx

Sheet Title:
EXISTING TREE INVENTORY

Date: 1/15/2024
Sheet Number:

LP-0.02 CONSTRUCTION DOCUMENT

EXISTING TREE LEGEND

SYMBOL	ACTION
	Retain
	Remove

See Sheet CD-5.02 for Existing Tree Protection Notes

EXISTING TREE REPORT

ID	BOTANICAL NAME	COMMON NAME	ACTION	CONDITION
E01	<i>Metrosideros excelsa</i>	New Zealand Christmas Tree	Retain	Average
E02	<i>Metrosideros excelsa</i>	New Zealand Christmas Tree	Retain	Average
E03	<i>Melaleuca quinquenervia</i>	Cajuput Tree	Remove	Poor
E04	<i>Pinus canariensis</i>	Canary Island Pine	Retain	Good
E05	<i>Pinus canariensis</i>	Canary Island Pine	Retain	Good
E06	<i>Pinus canariensis</i>	Canary Island Pine	Retain	Good
E07	<i>Pinus canariensis</i>	Canary Island Pine	Retain	Good
E08	<i>Melaleuca quinquenervia</i>	Cajuput Tree	Remove	Poor
E09	<i>Melaleuca quinquenervia</i>	Cajuput Tree	Remove	Poor
E10	<i>Melaleuca quinquenervia</i>	Cajuput Tree	Remove	Average
E11	<i>Pinus canariensis</i>	Canary Island Pine	Remove	Good
E12	<i>Pinus canariensis</i>	Canary Island Pine	Retain	Good
E13	<i>Pinus canariensis</i>	Canary Island Pine	Remove	Good
E14	<i>Pinus ponderosa</i>	Ponderosa Pine	Retain	Good
E15	<i>Pinus canariensis</i>	Canary Island Pine	Remove	Average
E16	<i>Pyrus kawakamii</i>	Evergreen Pear	Retain	Good
E17	<i>Pyrus kawakamii</i>	Evergreen Pear	Remove	Good
E18	<i>Pyrus kawakamii</i>	Evergreen Pear	Remove	Good
E19	<i>Cupaniopsis anacardioides</i>	Carrot Wood	Retain	Good
E20	<i>Cupaniopsis anacardioides</i>	Carrot Wood	Remove	Poor
E21	<i>Canary Island Pines</i>	<i>Pinus canariensis</i>	Retain	Good
E22	<i>Canary Island Pines</i>	<i>Pinus canariensis</i>	Retain	Good
E23	<i>Pinus halepensis</i>	Aleppo Pine	Retain	Average
E24	<i>Pinus halepensis</i>	Aleppo Pine	Retain	Average
E25	<i>Pinus halepensis</i>	Aleppo Pine	Retain	Average
E26	<i>Phoenix canariensis</i>	Canary Island Date Palm	Remove	Good
E27	<i>Washingtonia robusta</i>	Mexican Fan Palm	Retain	Good
E28	<i>Eucalyptus sideroxylon</i>	Red Ironbark	Remove	Poor
E29	<i>Washingtonia robusta</i>	Mexican Fan Palm	Remove	Good
E30	<i>Cupaniopsis anacardioides</i>	Carrotwood	Remove	Good
E31	<i>Washingtonia robusta</i>	Mexican Fan Palm	Remove	Good
E32	<i>Eucalyptus globulus</i>	Blue Gum Eucalyptus	Retain	Average
E33	<i>Eucalyptus globulus</i>	Blue Gum Eucalyptus	Retain	Average
E34	<i>Eucalyptus globulus</i>	Blue Gum Eucalyptus	Retain	Poor
E35	<i>Eucalyptus globulus</i>	Blue Gum Eucalyptus	Retain	Average
E36	<i>Eucalyptus globulus</i>	Blue Gum Eucalyptus	Retain	Average
E37	<i>Eucalyptus globulus</i>	Blue Gum Eucalyptus	Retain	Average
E38	<i>Eucalyptus globulus</i>	Blue Gum Eucalyptus	Retain	Poor
E39	<i>Eucalyptus globulus</i>	Blue Gum Eucalyptus	Retain	Average
E40	<i>Eucalyptus globulus</i>	Blue Gum Eucalyptus	Retain	Average
E41	<i>Eucalyptus globulus</i>	Blue Gum Eucalyptus	Retain	Average
E42	<i>Eucalyptus globulus</i>	Blue Gum Eucalyptus	Retain	Average
E43	<i>Eucalyptus globulus</i>	Blue Gum Eucalyptus	Retain	Average
E44	<i>Eucalyptus globulus</i>	Blue Gum Eucalyptus	Retain	Average
E45	<i>Eucalyptus globulus</i>	Blue Gum Eucalyptus	Retain	Average
E46	<i>Eucalyptus globulus</i>	Blue Gum Eucalyptus	Retain	Average
E47	<i>Eucalyptus globulus</i>	Blue Gum Eucalyptus	Retain	Poor
E48	<i>Eucalyptus globulus</i>	Blue Gum Eucalyptus	Retain	Average
E49	<i>Eucalyptus globulus</i>	Blue Gum Eucalyptus	Retain	Average
E50	<i>Eucalyptus globulus</i>	Blue Gum Eucalyptus	Remove	Good
E51	<i>Eucalyptus globulus</i>	Blue Gum Eucalyptus	Remove	Poor
E52	<i>Eucalyptus globulus</i>	Blue Gum Eucalyptus	Remove	Good
E53	<i>Fraxinus uhdei</i>	Shamel Ash	Remove	Average
E54	<i>Ficus rubidginosa</i>	Rusty Leaf Fig	Remove	Not Set
E55	<i>Fraxinus uhdei</i>	Shamel Ash	Remove	Poor
E56	<i>Eriobotrya deflexa</i>	Bronze Loquat	Remove	Good
E57	<i>Ficus lurida</i>	Fiddleleaf Fig	Remove	Good

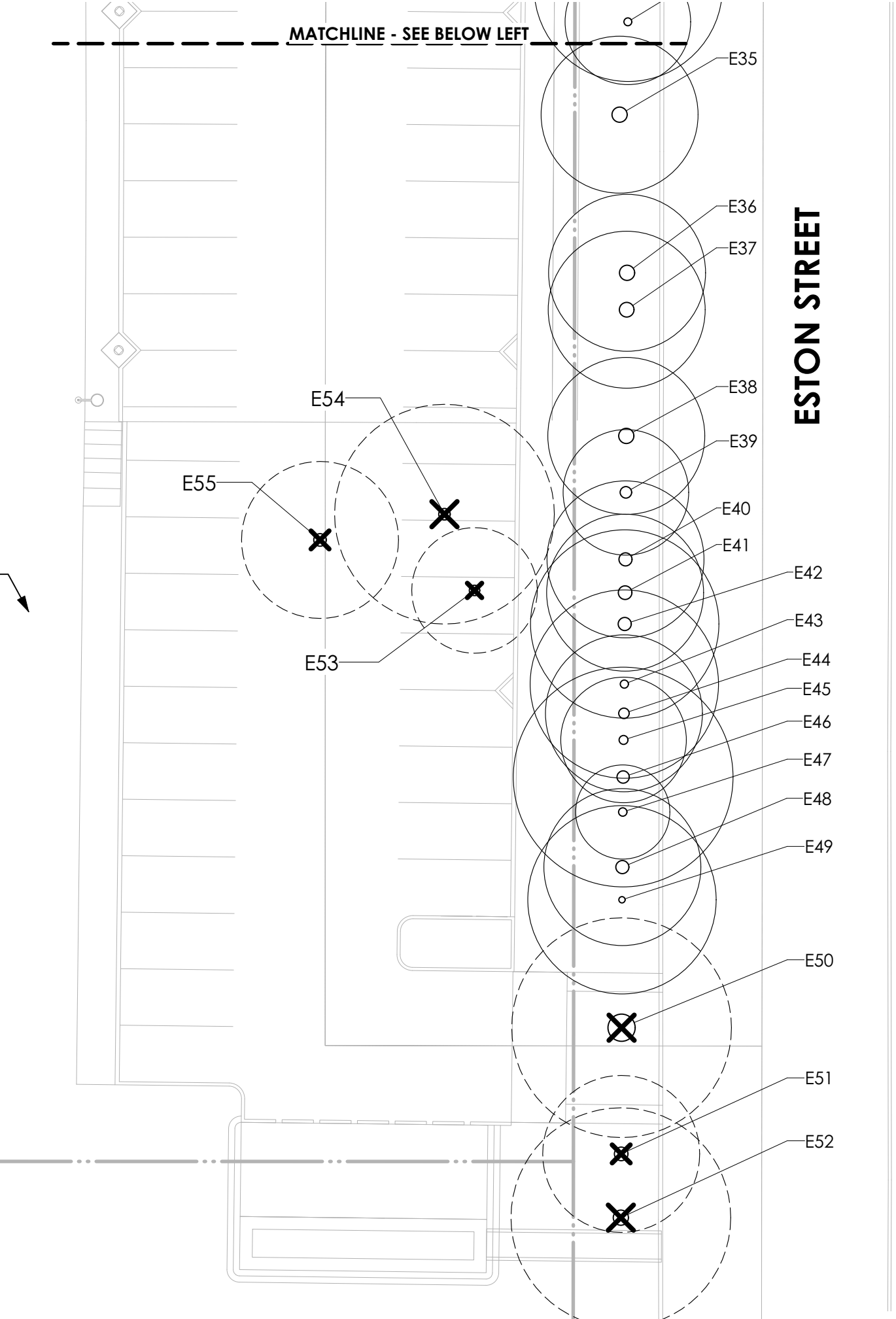
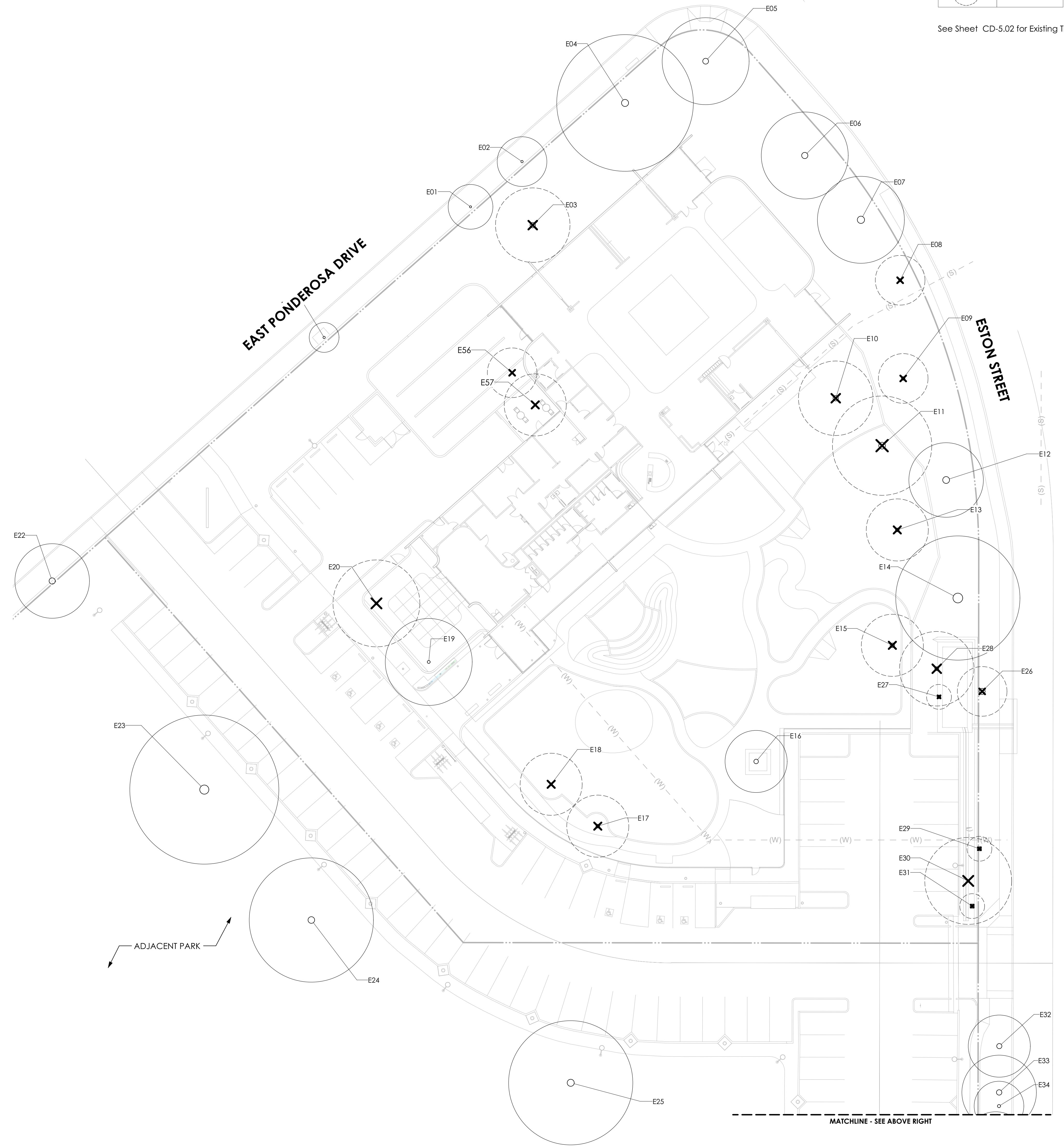

EXISTING TREE PLAN

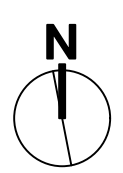
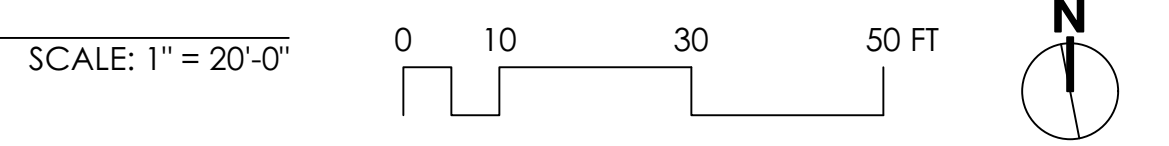

Date: Monday, January 15, 2024
Time: 9:54:02 AM
File name: P:\Pacific Coast Land Design, Inc\PROJECTS - Documents\21-011_KIDSTREAM MUSEUM\CAD\21-011_L-Project.vwx

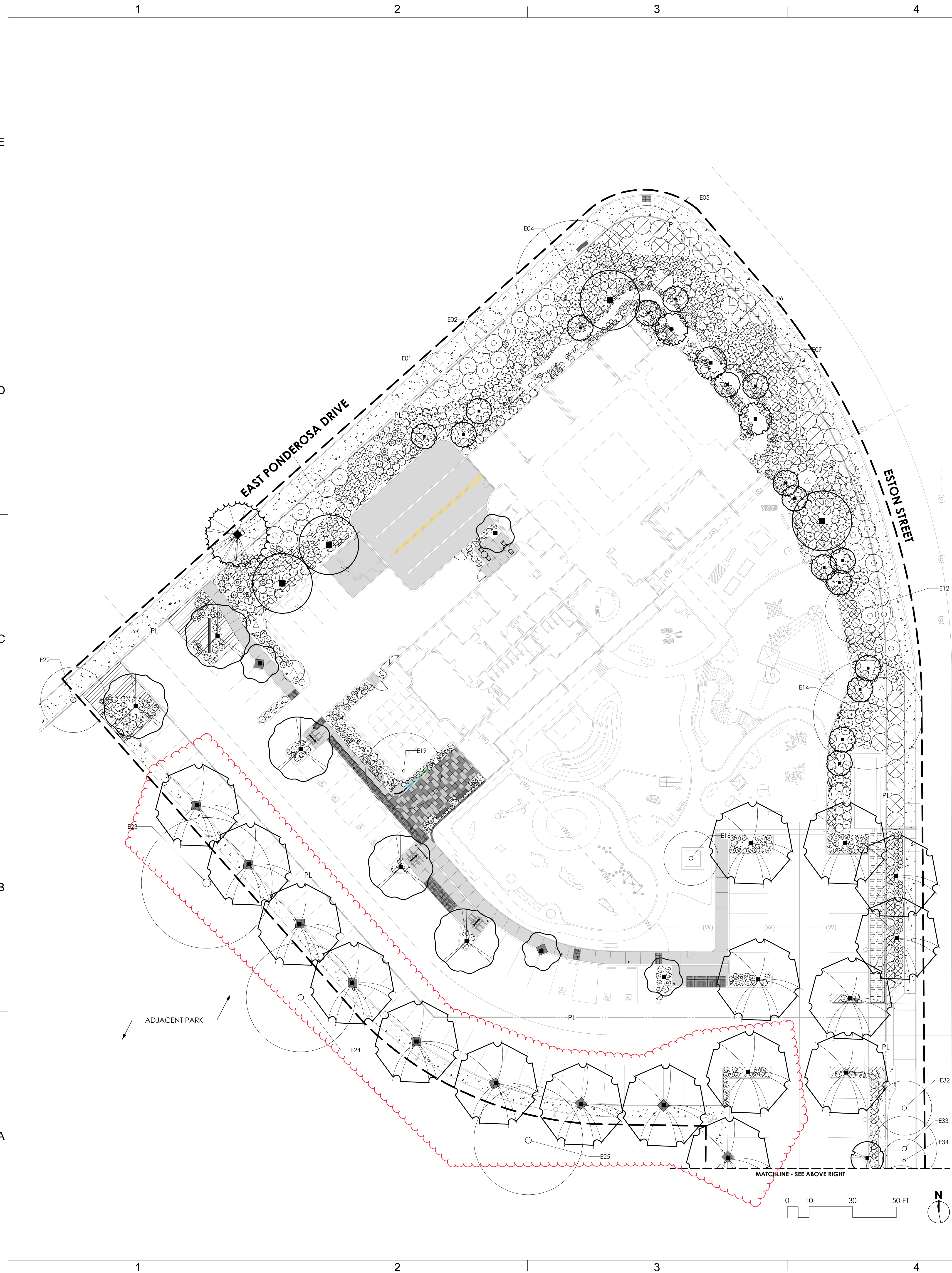

EXISTING TREE PROTECTION NOTES

- TREES THAT ARE REMOVED SHALL INCLUDE THE REMOVAL OF ROOTS.
- NO ROTOTILLING UNDER TREE CANOPY OF EXISTING TREE TRUNKS. AMENDMENTS SHALL BE TURNED INTO THE SOIL BY HAND IN THESE AREAS OR AS SPECIFIED BY THE CITY ARBORIST.
- NO COMPACTION OF SOIL UNDER EXISTING TREES IS ALLOWED. THIS INCLUDES THE STOCK PILING OF SOIL AND OTHER MATERIALS.
- EXISTING TREES SHALL HAVE THEIR DEAD WOOD REMOVED AND/OR PRUNED FOR HEALTH & SAFETY UNDER THE DIRECTION OF AN ISA CERTIFIED ARBORIST. NO MORE THAN 5% OF THE TOTAL FOLIAGE MAY BE REMOVED.
- DO NOT RAISE GRADE AROUND EXISTING TREES TO REMAIN.
- CONTRACTOR SHALL PRESERVE & PROTECT IN PLACE EXISTING TREES THAT ARE TO REMAIN. DAMAGE TO PROTECTED SITE FEATURES SHALL BE REPLACED IN KIND AT CONTRACTOR'S EXPENSE.
- ALL PRUNING SHALL BE AUTHORIZED AND PERFORMED UNDER THE DIRECTION OF THE ARBORIST AND SHALL CONFORM TO THE INTERNATIONAL SOCIETY OF ARBORICULTURE (ISA) STANDARDS. THERE WILL BE NO FLUSH CUTTING ALLOWED.
- PRIOR TO COMMENCEMENT OF CLEARING, GRUBBING, TRENCHING, GRADING OR ANY SITE DISTURBANCES, TREE PROTECTION FENCING MUST BE INSTALLED AROUND THE EXISTING TREES TO REMAIN. 6' HT. CONSTRUCTION FENCING WITH FIXED POSTS MUST BE INSTALLED AROUND THE TREE PROTECTION ZONE (TPZ). THE FENCING SHALL REMAIN IN PLACE THROUGHOUT THE ENTIRE CONSTRUCTION PERIOD.
- ONE ENGLISH LANGUAGE AND ONE SPANISH LANGUAGE, READILY-VISIBLE, DURABLE, WATERPROOF SIGN SHALL BE INSTALLED ON THE FENCE IN 4 LOCATIONS AROUND THE TREES. THE SIZE OF EACH SIGN MUST BE A MINIMUM OF 16 INCHES WIDE AND MUST CONTAIN THE FOLLOWING TEXT (THE LETTERING IN 'WARNING' MUST BE IN CAPITAL LETTERS AND 2 INCHES HIGH; 'TREE PROTECTION ZONE' MUST BE IN CAPITAL LETTERS AND 1 INCH HIGH; ALL OTHER LETTERING MUST BE AT LEAST 1/2 INCH SIZE):

WARNING
TREE PROTECTION ZONE
ENTRY PROHIBITED. THIS FENCE SHALL REMAIN IN PLACE THROUGHOUT THE ENTIRE CONSTRUCTION PERIOD. TO REPORT VIOLATIONS, CONTACT CONSTRUCTION SUPERINTENDENT.

ADVERTENCIA
ZONA DE PROTECCIÓN DE ÁRBOLES
ENTRADA PROHIBIDA. ESTA CERCA DEBE PERMANECER EN SU LUGAR DURANTE EL PERIODO DE CONSTRUCCIÓN. PARA REPORTAR VIOLACIONES, CONTACTE AL ENFORZAMIENTO.
- NO CONSTRUCTION EQUIPMENT, SOIL OR OTHER CONSTRUCTION MATERIALS SHALL BE PLACED WITHIN THE TPZ. NO OIL, GASOLINE, CHEMICALS, PAINTS, SOLVENTS OR OTHER HAZARDOUS MATERIALS MAY BE DEPOSITED WITHIN THE TPZ OR IN DRAINAGE CHANNELS, SWALES OR AREAS THAT MAY FLOW TO THE TPZ.
- ALL WORK DONE WITHIN THE TPZ, INCLUDING BRUSH CLEARANCE, DIGGING, AND TRENCHING SHALL BE DONE WITH HAND TOOLS OR SMALL HAND HELD POWER TOOLS THAT WILL NOT CAUSE ROOT DAMAGE.
- ANY WORK DONE WITHIN THE TPZ NOT USING HAND TOOLS MUST BE APPROVED AND MONITORED BY THE ARBORIST.
- NO PLANT MATERIAL SHALL BE INSTALLED WITHIN THE TREE PROTECTION ZONE (HALF WAY BETWEEN THE TRUNK AND CANOPY).

PLANTING NOTES

- SEE SHEET LP-0.01 FOR DETAILED PLANTING SCHEDULES AND NOTES.

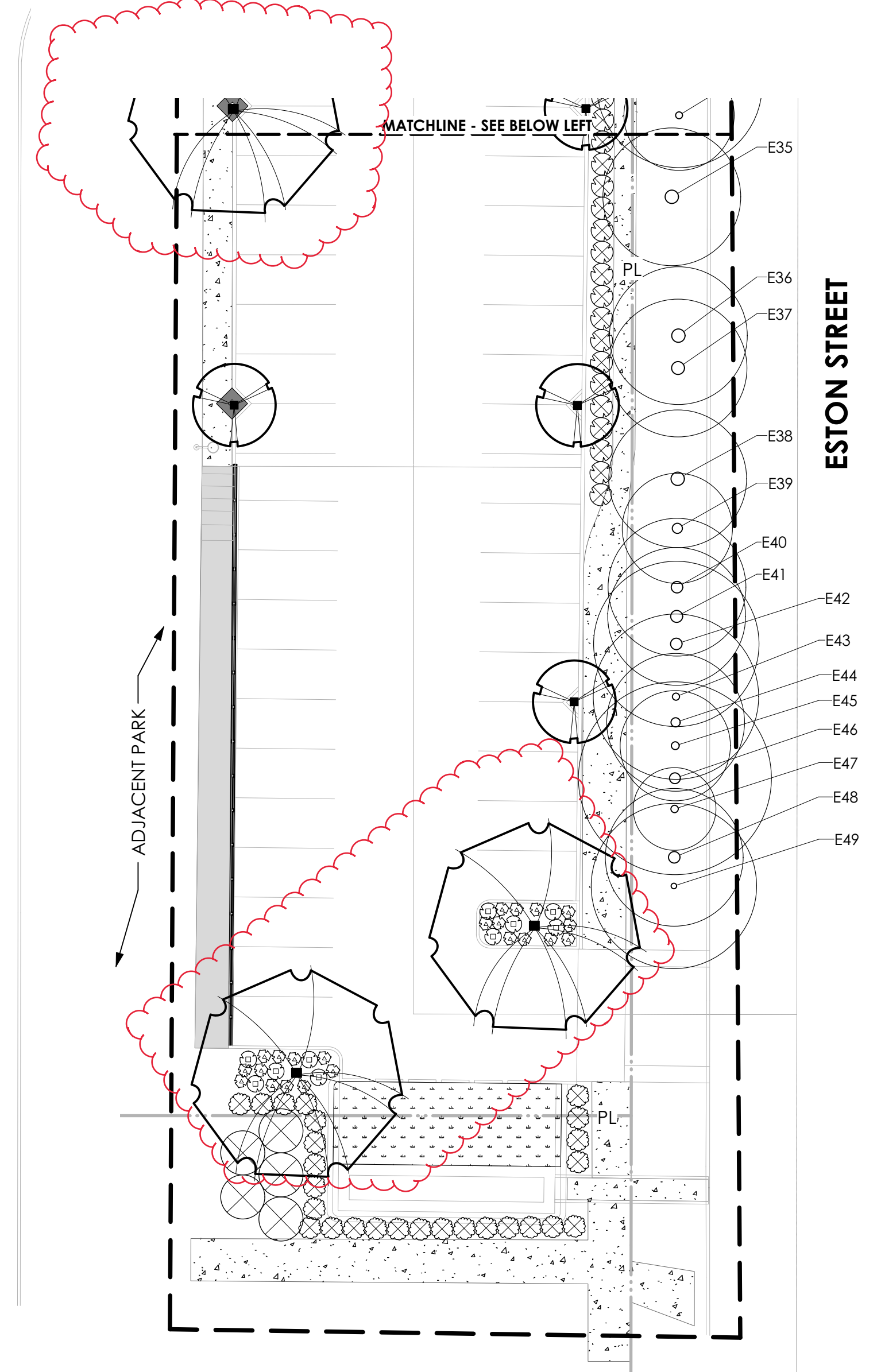

PLANT SCHEDULE (THIS SHEET)

SYMBOL	LATIN NAME	SIZE
TREES		
◻	<i>Arbutus x 'Marina'</i>	24" Box
◻	<i>Cassia leptophylla</i>	24" Box
◻	<i>Cercis occidentalis</i>	24" Box
◻	<i>Lagerstroemia indica 'Natchez'</i>	24" Box
◻	<i>Magnolia grandiflora 'Little Gem'</i>	24" Box
◻	<i>Pinus canariensis</i>	24" Box
◻	<i>Pistacia chinensis</i>	24" Box
◻	<i>Platanus racemosa</i>	24" Box
SHRUBS		
⊗	<i>Agave 'Blue Flame'</i>	5 gal
⊗	<i>Agave vilmoriniana</i>	5 gal
⊗	<i>Aloe striata</i>	1 gal
⊗	<i>Arctostaphylos 'Dr. Hurd'</i>	15 gal
⊗	<i>Asparagus densiflorus 'Myers'</i>	1 gal
⊗	<i>Bouteloua gracilis 'Blonde Ambition'</i>	1 gal
⊗	<i>Ceanothus griseus 'horizontalis 'Yankee Point'</i>	1 gal
⊗	<i>Crassula capitella 'Campfire'</i>	1 gal
⊗	<i>Crassula ovata 'Gollum'</i>	1 gal
⊗	<i>Crassula perforata</i>	1 gal
⊗	<i>Dianella revoluta 'DR5000' P.P.# 17719</i>	1 gal
⊗	<i>Dudleya brittonii</i>	1 gal
⊗	<i>Euonymus japonicus 'Green Spire'</i>	15 gal
⊗	<i>Garrya elliptica</i>	15 gal
⊗	<i>Gaura lindheimeri</i>	1 gal
⊗	<i>Helictotrichon sempervirens</i>	1 gal
⊗	<i>Kalanchoe luciae</i>	1 gal
⊗	<i>Lavandula x intermedia 'Provence'</i>	1 gal
⊗	<i>Mimulus aurantiacus</i>	1 gal
⊗	<i>Muhlenbergia capillaris</i>	5 gal
⊗	<i>Muhlenbergia dubia</i>	5 gal
⊗	<i>Muhlenbergia lindheimeri 'Autumn Glow'</i>	5 gal
⊗	<i>Muhlenbergia rigens</i>	5 gal
⊗	<i>Myoporum parvifolium 'Putah Creek'</i>	1 gal
⊗	<i>Pelargonium tomentosum</i>	1 gal
⊗	<i>Pittosporum crassifolium 'Compactum'</i>	5 gal
⊗	<i>Polystichum munitum</i>	1 gal
⊗	<i>Rhaphiolepis umbellata</i>	5 gal
⊗	<i>Romneya coulteri</i>	15 gal
⊗	<i>Rosmarinus officinalis 'Tuscan Blue'</i>	1 gal
⊗	<i>Salvia greggii 'Alba'</i>	1 gal
⊗	<i>Salvia leucantha</i>	1 gal
⊗	<i>Sansevieria trifasciata 'Moonshine'</i>	1 gal
⊗	<i>Senecio cylindricus</i>	1 gal
⊗	<i>Stachys byzantina</i>	1 gal
⊗	<i>Teucrium cossonii</i>	1 gal
⊗	<i>Verbena ilicifolia 'De La Mina'</i>	1 gal
⊗	<i>Westringia fruticosa 'Morning Light'</i>	5 gal
VINES		
⊗	<i>Distictis buccinatoria</i>	15 gal
⊗	<i>Parthenocissus 'Hacienda Creeper'</i>	15 gal
GROUNDCOVERS AND TURF		
⊗	<i>Carex proeagrallis</i>	1 gal
⊗	<i>Echeveria 'Ruffles'</i>	1 gal
⊗	<i>Eriogonum karvinskianus</i>	1 gal
⊗	<i>Senecio serpens</i>	from Flats
⊗	<i>Thymus praecox arcticus</i>	from Flats
⊗	Biofiltration Mix	Sod

ANDERSON KULWIEC APPELBY ARCHITECTS

ARCHITECTURE
PLANNING
INTERIOR DESIGN
David Anderson A.I.A., Architect
Marilyn Appelby A.I.A., Architect
854 East Main Street, Suite 100
Santa Paula, California 93060
(805) 933-0225
(805) 933-6609 FAX



Consultants:
Pacific Coast Land Design Inc.
Landscape Architecture - Urban Design - Environmental Planning
461 Main Street
Ventura, California 93001
(805) 644-9697

Architect's Project Number:
2022-104
Project:
kidSTREAM CHILDREN'S MUSEUM ADAPTIVE REUSE

3100 East Ponderosa Drive
Camarillo, California 93010
Owner:
kidSTREAM Children s Museum in Ventura County
3100 East Ponderosa Drive
Camarillo, California 93010

Date	Description
REVISIONS	

Num	Date	Description
ISSUE RECORD		

COPYRIGHT 2022
THIS DOCUMENT AND THE IDEAS AND DESIGNS INCORPORATED HEREIN, AS INSTRUMENTS OF PROFESSIONAL SERVICE, ARE THE PROPERTY OF ANDERSON KULWIEC APPELBY ARCHITECTS AND ARE NOT TO BE USED, IN WHOLE OR IN PART, FOR ANY PROJECT WITHOUT THE WRITTEN AUTHORIZATION OF ANDERSON KULWIEC APPELBY ARCHITECTS.

Drawn by:
Checked by:
CAD File Name: 21-011_L-Project.wvx

Sheet Title:
PLANTING PLAN

Date: 1/15/2024
Sheet Number:

LP-1.01
CONSTRUCTION DOCUMENT

WALL AND FENCE SCHEDULE

ID#	ITEM	DESCRIPTION	DETAIL
W-1	ENTRY WALL	CMU BLOCK WALL WITH SMOOTH STUCCO FINISH AND 3 COURSES BREEZE BLOCK. COLOR TO MATCH ARCHITECTURE.	B/LC-2.02
W-2	WROUGHT IRON GATE	5'-0" HT. BLACK WROUGHT IRON GATE	C/LC-2.02
W-3	RETAINING WALL W/ GALV. FENCE	RETAINING WALL WITH GALVANIZED STEEL FENCE ATOP. HEIGHT OF WALL/FENCE VARIES DUE TO SLOPE.	A/LC-2.02

PAVING SCHEDULE

ID#	ITEM	DESCRIPTION	DETAIL
P-1	PEDESTRIAN PAVING	NATURAL GRAY CONCRETE WITH HEAVY BROOM FINISH PERPENDICULAR TO WALKWAY. SAWCUT CONTROL JOINTS. ADD FELT EXPANSION JOINTS AT 30' O.C. MAX., AT KEY INTERSECTIONS, AND WHERE CONCRETE MEETS STRUCTURAL FOOTINGS.	A&B/LC-2.01
P-2	OUTDOOR EXHIBIT PAVING- VEHICULAR	INTEGRALLY COLORED CONCRETE WITH HEAVY BROOM FINISH PERPENDICULAR TO WALKWAY. SAWCUT CONTROL JOINTS. SECTION PER CIVIL ENGINEER AND GEOTECHNICAL REPORT. DAVIS COLOR GRAPHITE '8084'	C/LC-2.01
P-3	PRIMARY ENTRANCE PAVING	24"x48" & 24"x24" 'PRIMA MATERIA' 10 mm PORCELAIN STONEWARE PAVING TILES. COLOR: CEMENTO & SANDALO. FINISH: GRIP. PATTERN: PER PLAN	D/DD-2.4
P-4	DETECTABLE WARNING SURFACE- PAVERS	ACKERSTONE 'PALAZZO 12x12 TRUNCATED DOMES' WARNING PAVER. COLOR: ONYX FM PTD-610. PATTERN: LINEAR IN STRAIGHT APPLICATIONS, RADIAL IN CURVED APPLICATIONS. AVAILABLE FROM ACKERSTONE (951)-674-0047 www.ackerstone.com	G/LC-2.01
P-5	FIRST RESPONDERS STRIPING	INSTALL 6" CENTER YELLOW DOUBLE NO PASSING ZONE DETAIL 21 PER CALTRANS STD PLAN A20A (THERMOPLASTIC). INSTALL 6" WHITE EDGELINE DETAIL 27B PER CALTRANS STD PLAN A20B.	N/A
P-6	EXISTING SIDEWALK	TO REMAIN. REFER TO CIVIL PLANS	N/A
P-7	ALUMINUM HEADER	ALUMINUM HEADER, PERMALOC OR EQ.	I/LC-2.01

AMENITIES SCHEDULE

ID#	ITEM	DESCRIPTION	DETAIL
A-1	ADA ACCESSIBLE TREE GRATE	48"x48" SQUARE, IRONSMITH ELEMENT 100% RECYCLED GRAY IRON TREE GRATE (#48GELEMSQ) WITH 1/4" MAXIMUM SLOT OPENINGS MEET ADA COMPLIANCE WITH 18" TREE OPENING AND IRONSMITH FULL SQUARE TREE GRATE FRAME (#48ROOF). FINISH PER DETAIL	F/LC-2.01
A-2	BIKE RACK	DERO ROLLING RACK RR2H: 5 BIKE RACK, IN-GROUND MOUNT, POWDERCOAT FINISH. COLOR: TBD	PER MANUF.
A-3	ENTRY MONUMENT	10"x8"x16" PRECISION CMU BLOCK WALL MONUMENT WITH SMOOTH STUCCO FINISH. 11.4" TESSELLE 'SHAMROCK WHITE' CEMENT BREEZE BLOCK INSERT AND CUSTOM BRANDED, PAINTED ALUMINUM, PIN-SET LETTERING BY IMAGEFACTOR SIGN MFR.	A/LC-2.03
A-4	SECONDARY SIGNAGE	'BUS PARKING' DIRECTIONAL WAYFINDING METAL SIGNAGE ON GALV. POST	H/LC-2.01
A-5	BISTRO TABLES & CHAIRS	TO BE PROVIDED BY OWNER	N/A
A-6	BOLLARD LIGHTING	FORMS + SURFACES LIGHT COLUMN BOLLARD. 360 DEGREE SHIELD IN 'SCALE' PATTERN. 600 SERIES. FINISH: STAINLESS STEEL W/ SATIN FINISH. SURFACE MOUNT WITH J-BOLTS PER MFR. RECOMMENDATIONS. REFER TO ELECTRICAL ENGINEER'S PLANS FOR LAMP AND DRIVER SPECIFICATIONS.	PER MANUF.
A-7	BENCH	6'-0" BENCH WITH RECYCLED TEAK HARDWOOD SLATS AND POWDERCOATED FRAME & LEGS. FORMS + SURFACES CIRCUIT BENCH, SB CIR72T, COLOR: TBD	PER MANUF.
A-8	25' FLAG POLE	LIBERTY FLAG POLE COMPANY 25' TAPERED ALUMINUM FLAGPOLE WITH EXTERNAL HALYARD. MODEL ECA25. FINISH: ANODIZED CLEAR. AVAILABLE FROM LIBERTY FLAG POLE COMPANY. 800-314-2392 www.libertyflagpoles.com	E/LC-2.01
A-9	CUSTOM LETTERING SIGNAGE	CUSTOM FREESTANDING MOLDED ALUMINUM. PAINTED LOGO LETTERING ON CONCRETE PLINTH. LETTERING BY IMAGEFACTOR SIGN MFR.	B/LC-2.03
A-10	SAFETY BOLLARD	FORMS + SURFACES LIGHT COLUMN NON-ILLUMINATED BOLLARD. NO SHIELD. 600 SERIES WITH EMBEDDED SECURITY CORE. FINISH: STAINLESS STEEL W/ SATIN FINISH.	PER MANUF.
A-11	SAFETY & LIGHTING BOLLARD	FORMS + SURFACES LIGHT COLUMN BOLLARD. 360 DEGREE SHIELD IN 'SCALE' PATTERN. 600 SERIES. FINISH: STAINLESS STEEL W/ SATIN FINISH. EMBEDDED SECURITY CORE PER MFR. RECOMMENDATIONS. REFER TO ELECTRICAL ENGINEER'S PLANS FOR LAMP AND DRIVER SPECIFICATIONS.	PER MANUF.
A-12	DECORATIVE BARRIER	CUSTOM 1-1/2" GALVANIZED STEEL, POWDERCOATED BARRIER. IMBED MOUNT. COLOR: TBD.	D/LC-2.02

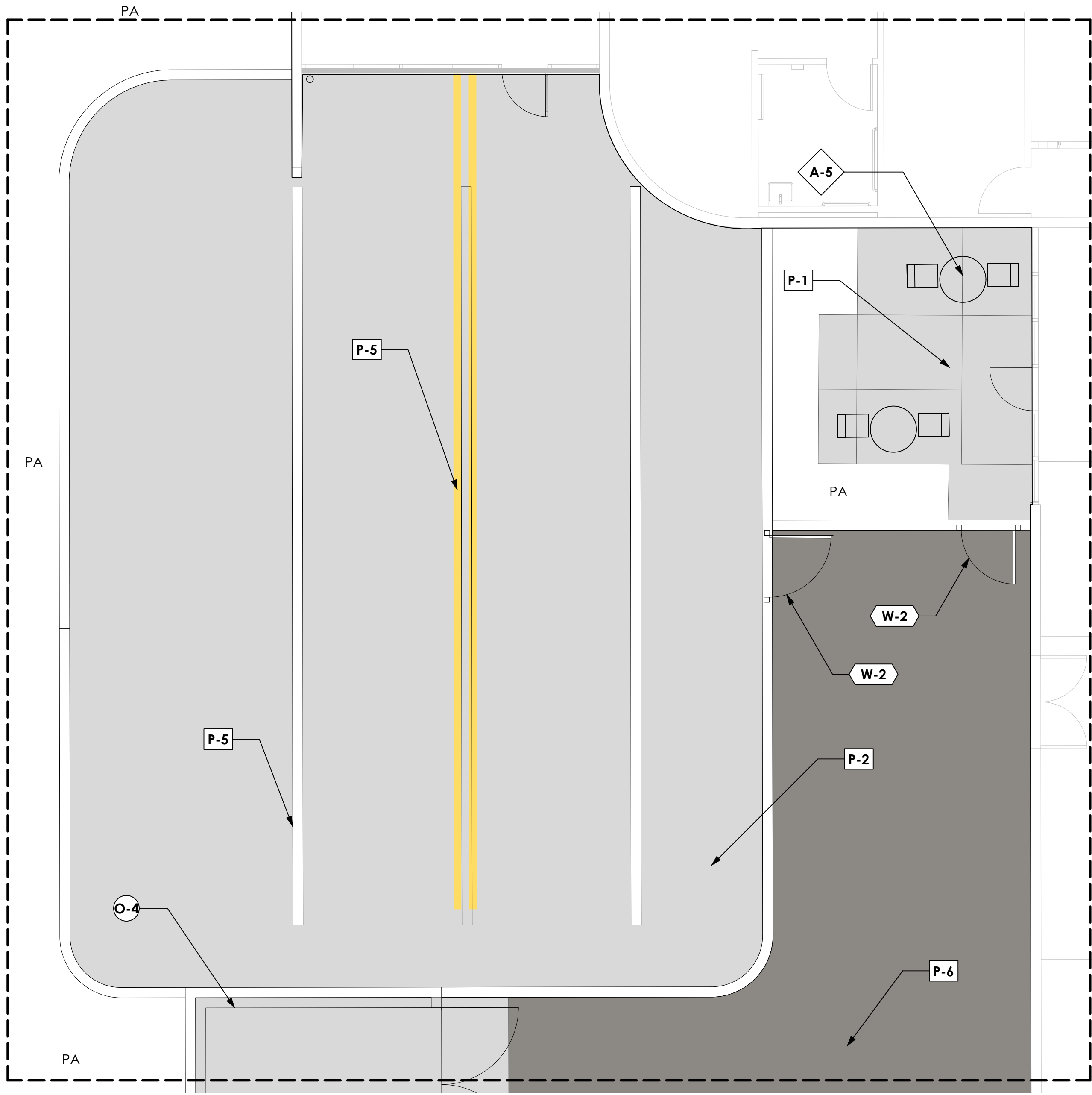

ENLARGEMENT- STAFF PATIO & FIRST RESPONDERS

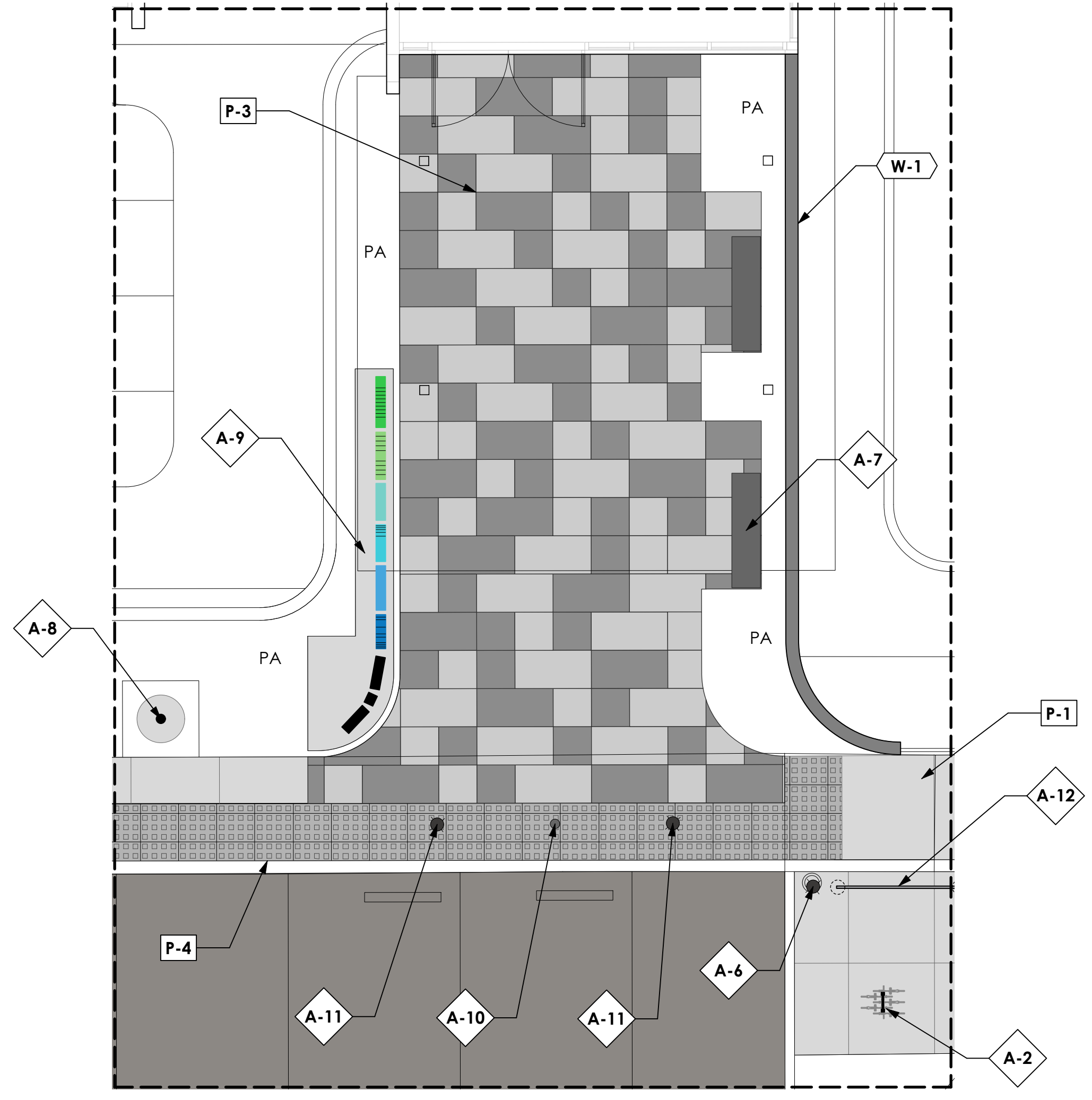
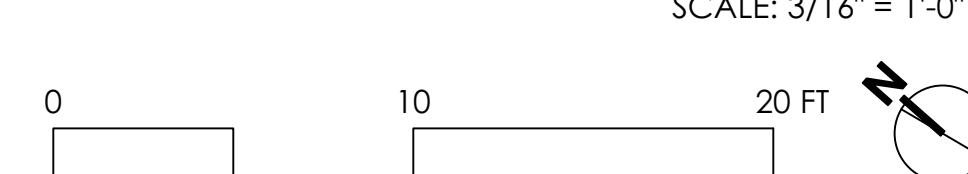

ENLARGEMENT- PRIMARY ENTRY

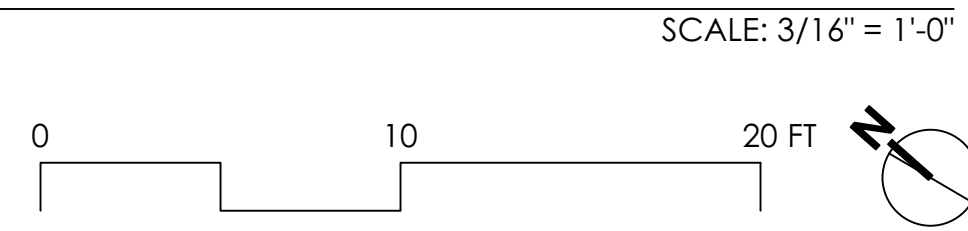

ANDERSON KULWIEC APPELBY ARCHITECTS

ARCHITECTURE
PLANNING
INTERIOR DESIGN
David Anderson A.I.A., Architect
Marilyn Appelby A.I.A., Architect
854 East Main Street, Suite 100
Santa Paula, California 93060
(805) 933-0225
(805) 933-6609 FAX

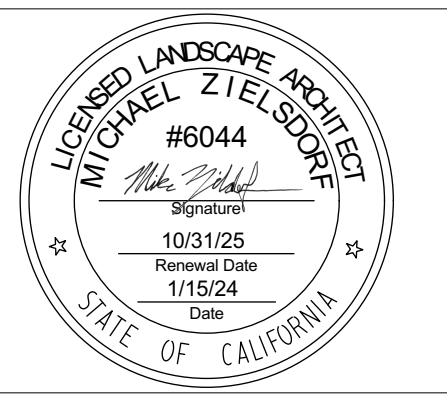

Consultants:
Pacific Coast Land Design Inc.
Landscape Architecture • Urban Design • Environmental Planning
461 Main Street
Ventura, California 93001
(805) 644-9697

Architect's Project Number:
2022-104

Project:
kidSTREAM CHILDREN'S MUSEUM ADAPTIVE REUSE

3100 East Ponderosa Drive
Camarillo, California 93010

Owner:
kidSTREAM Children's Museum in Ventura County
3100 East Ponderosa Drive
Camarillo, California 93010

Date	Description
REVISIONS	

Num	Date	Description
ISSUE RECORD		

COPYRIGHT 2022
THIS DOCUMENT AND THE IDEAS AND DESIGNS INCORPORATED HEREIN, AS INSTRUMENTS OF PROFESSIONAL SERVICE, ARE THE PROPERTY OF ANDERSON KULWIEC APPELBY ARCHITECTS AND ARE NOT TO BE USED, IN WHOLE OR IN PART, FOR ANY PROJECT WITHOUT THE WRITTEN AUTHORIZATION OF ANDERSON KULWIEC APPELBY ARCHITECTS.

Drawn by:
Checked by:
CAD File Name: 21-011_L-Project.vwx

Sheet Title:
ENLARGEMENT AREAS

Date: 3/18/2024
Sheet Number:

LC-1.02
CONSTRUCTION DOCUMENT

DEMOLITION NOTES

1. SAWCUT AND REMOVE EXISTING CONCRETE DRIVEWAY APRON, CURB & GUTTER, AND SIDEWALK.
2. SAWCUT AND REMOVE EXISTING CONCRETE CURB & GUTTER AND SIDEWALK.
3. SAWCUT AND REMOVE EXISTING CURB RAMP, CURB, AND SIDEWALK.
4. SAWCUT AND REMOVE EXISTING ASPHALT CONCRETE.
5. SAWCUT AND REMOVE EXISTING CONCRETE CURB, SIDEWALK, AND ASPHALT CONCRETE AT PROPOSED DIAMOND PLANTER LOCATIONS.
6. SAWCUT AND REMOVE EXISTING CONCRETE CURB.
7. SAWCUT AND REMOVE EXISTING CONCRETE CURB & GUTTER.
8. SAWCUT AND REMOVE EXISTING CONCRETE SIDEWALK.
9. REMOVE EXISTING CMU WALL.
10. REMOVE EXISTING CONCRETE RAMP.
11. REMOVE EXISTING TREE.
12. RELOCATE EXISTING IRRIGATION WATER LINE RISER PER LANDSCAPE PLANS.
13. PROTECT EXISTING NOTED FEATURE IN PLACE.
14. REMOVE AND REPLACE EXISTING CURB AND GUTTER IN KIND.

GENERAL DEMOLITION NOTES

- CONTRACTOR IS RESPONSIBLE FOR THE DEMOLITION, REMOVAL, AND PROPER DISPOSAL OF ALL REMOVED FEATURES. ALL FACILITIES TO BE REMOVED SHALL BE UNDERCUT TO SUITABLE MATERIAL AND BROUGHT TO GRADE WITH SUITABLE COMPACTED FILL MATERIAL PER THE SOILS ENGINEER'S RECOMMENDATIONS.
- CONTRACTOR IS RESPONSIBLE FOR REMOVING ALL DEBRIS FROM THE SITE AND DISPOSING THE DEBRIS IN A LAWFUL MANNER. CONTRACTOR IS RESPONSIBLE FOR OBTAINING ALL NECESSARY PERMITS FOR DEMOLITION AND DISPOSAL.
- CONTRACTOR SHALL COORDINATE WITH RESPECTIVE UTILITY COMPANIES PRIOR TO THE REMOVAL AND/OR RELOCATION OF UTILITIES. CONTRACTOR SHALL COORDINATE WITH THE UTILITY COMPANY CONCERNING PORTIONS OF WORK WHICH MAY BE PERFORMED BY THE UTILITY COMPANY AND ANY FEES WHICH ARE TO BE PAID TO THE UTILITY COMPANY FOR THEIR SERVICES SHALL BE PAID BY THE CONTRACTOR.
- CONTRACTOR SHALL BE RESPONSIBLE FOR THE DISCONNECTION OF UTILITY SERVICES TO THE EXISTING BUILDINGS AS NECESSARY.
- THE LOCATIONS OF ALL EXISTING UTILITIES SHOWN ON THIS PLAN HAVE BEEN DETERMINED FROM THE BEST INFORMATION AVAILABLE AND ARE GIVEN FOR THE CONVENIENCE OF THE CONTRACTOR. THE ENGINEER ASSUMES NO RESPONSIBILITY FOR THEIR ACCURACY. PRIOR TO THE START OF ANY DEMOLITION ACTIVITY, CONTRACTOR SHALL NOTIFY THE UTILITY COMPANIES FOR ONSITE LOCATIONS OF EXISTING UTILITIES.
- ALL EXISTING SEWERS, PIPING AND UTILITIES SHOWN ARE NOT TO BE INTERPRETED AS THE EXACT LOCATION, OR AS THE ONLY OBSTACLES THAT MAY OCCUR ON THE SITE. CONTRACTOR SHALL VERIFY EXISTING CONDITIONS, PROCEED WITH CAUTION AROUND ANY ANTICIPATED FEATURES, GIVE NOTICE TO ALL UTILITY COMPANIES REGARDING DESTRUCTION AND REMOVAL OF ALL SERVICE LINES, AND CAP ALL LINES BEFORE PROCEEDING WITH WORK.
- CONTRACTOR MUST PROTECT THE PUBLIC AT ALL TIMES WITH FENCING, BARRICADES, ENCLOSURES, SIGNAGE, TRAFFIC CONTROL, ETC. TO BEST PRACTICES.
- PRIOR TO DEMOLITION OCCURRING, ALL EROSION CONTROL DEVICES ARE TO BE INSTALLED.
- SHOULD CONSTRUCTION ACTIVITIES DAMAGE EXISTING FACILITIES, THEN CONTRACTOR SHALL REPAIR/REPLACE IN KIND. EXCEPT FOR MATERIALS DESIGNATED TO BE RELOCATED ON THIS PLAN, ALL OTHER CONSTRUCTION MATERIALS SHALL BE NEW.
- CONTRACTOR MAY LIMIT SAW-CUT & PAVEMENT REMOVAL TO ONLY THOSE AREAS WHERE IT IS REQUIRED AS SHOWN ON THESE CONSTRUCTION PLANS, HOWEVER, IF ADDITIONAL REMOVALS ARE REQUIRED FOR CONSTRUCTABILITY OR DAMAGE IS INCURRED ON ANY OF THE SURROUNDING PAVEMENT, ETC., CONTRACTOR SHALL BE RESPONSIBLE FOR ITS REMOVAL AND REPAIR.

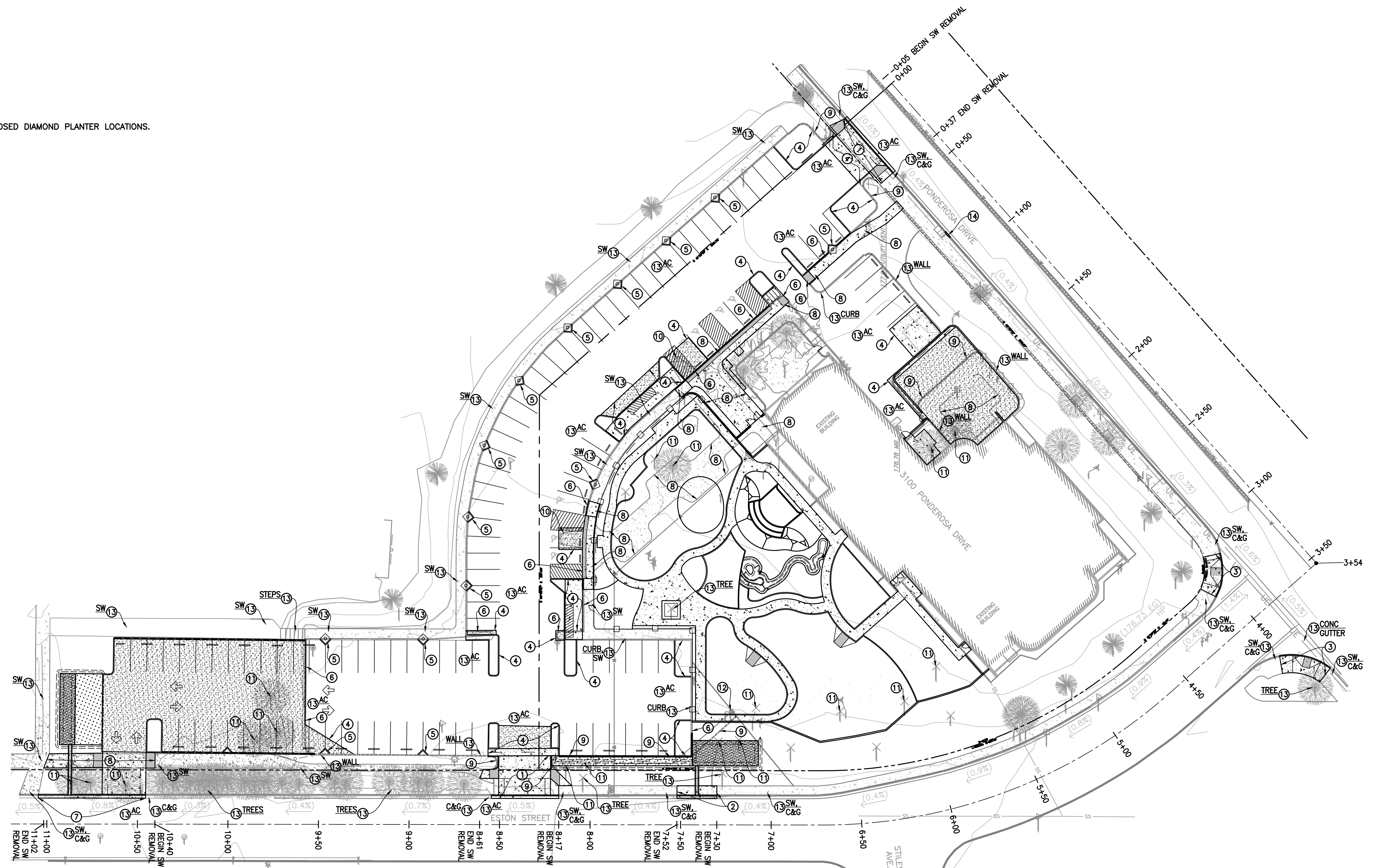

LEGEND

- PROPERTY LINE
- RIGHT-OF-WAY LINE
- CENTER LINE
- PROPOSED RETAINING WALL
- EXISTING BLOCK WALL
- PROPOSED SUBDRAIN LINE
- PROPOSED DRAIN LINE
- PROPOSED DRAIN INLET
- ⊙ PROPOSED SUMP PUMP WELL
- 2.5% DIRECTIONAL FLOW ARROW

ABBREVIATIONS

- CONC CONCRETE
- AC ASPHALT CONCRETE PAVEMENT
- BC BOTTOM OF CURB
- C&G CURB AND GUTTER
- CMU CONCRETE MASONRY UNIT WALL
- EG EXISTING GRADE
- EX EXISTING
- FF FINISHED FLOOR
- FL FLOW LINE
- FS FINISHED SURFACE
- FG FINISHED GRADE
- SG SUB-GRADE
- INV INVERT ELEVATION
- SW SIDE WALK
- TB TOP OF BERM
- TC TOP OF CURB
- TG TOP OF GRATE
- TW TOP OF WALL
- WM WATER METER

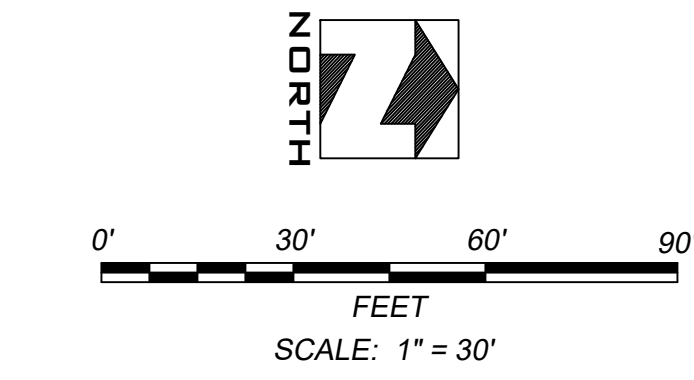

PLAN CHECK CONSULTANT
WILLDAN Engineering
 314 HOLY STREET, SUITE 101
 VENTURA, CALIFORNIA 93001
 (805) 653-6997

PREPARED BY: **M³ CIVIL**
 Consulting Civil Engineers
 4000 Calle Tecate, Suite 108
 Camarillo, CA 93012
 (805) 445-4404

JACOB G. LUKIEWSKI DATE
 RCE 71534 EXPIRES: 12/31/2023

REVIEWED:	
DIRECTOR of COMMUNITY DEVELOPMENT	DATE
REVIEWED:	
DEPUTY DIRECTOR, CAPITAL PROJECTS	DATE
REVIEWED:	
TRAFFIC ENGINEER	DATE
REVIEWED:	
MAINTENANCE SUPERINTENDENT	DATE
REVIEWED:	
DEPUTY DIRECTOR, ENVIRONMENTAL/STORMWATER	DATE
REVIEWED:	
WATER SUPERINTENDENT	DATE
REVIEWED:	
WATER RECLAMATION SUPERINTENDENT	DATE

REV.	DESCRIPTION	APP'D	DATE
DEPARTMENT OF PUBLIC WORKS CITY OF CAMARILLO			
DEMOLITION PLAN CUP-412 KIDSTREAM CHILDREN'S MUSEUM 3100 PONDEROSA DR., CAMARILLO, CA			
DRN BY:	DES BY:	CK'D BY:	
APPROVED:			
CITY ENGINEER		DATE	
DEPARTMENT OF PUBLIC WORKS			
RCE 76459 EXPIRES: 12/31/2024			
RECOMMENDED BY:			
SPEC. NUMBER	PROJ. NUMBER		
F.B.	PG.	SHEET 3 OF 13	C-18402

IMPORTANT NOTICE
 Section 4216/4217 of the Government Code requires a DigAlert identification Number be issued before a "Permit to Excavate" will be valid. For your DigAlert I.D. Number Call Underground Service Alert
TOLL FREE 811
 Two working days before you dig

UNDERGROUND SERVICE ALERT

 CALL BEFORE YOU DIG
 CALL: TOLL FREE 811
 TWO WORKING DAYS BEFORE DIGGING

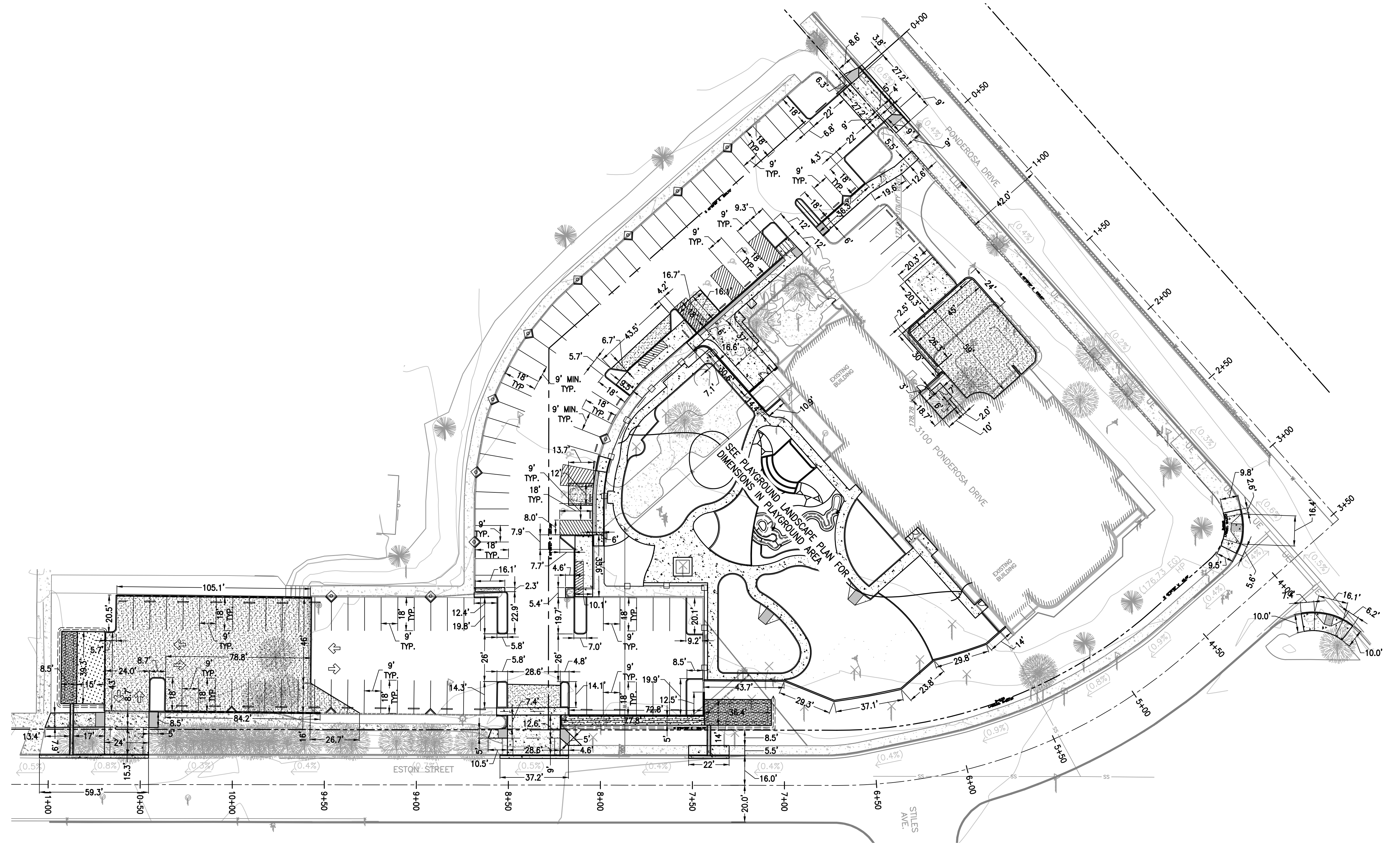

LEGEND

- PROPERTY LINE
- RIGHT-OF-WAY LINE
- CENTER LINE
- PROPOSED RETAINING WALL
- EXISTING BLOCK WALL
- PROPOSED SUBDRAIN LINE
- PROPOSED DRAIN LINE
- PROPOSED DRAIN INLET
- ⊞ PROPOSED SUMP PUMP WELL
- ▲ 2.5% DIRECTIONAL FLOW ARROW

ABBREVIATIONS

- CONC CONCRETE
- AC ASPHALT CONCRETE PAVEMENT
- BC BOTTOM OF CURB
- C&G CURB AND GUTTER
- CMU CONCRETE MASONRY UNIT WALL
- EG EXISTING GRADE
- EX EXISTING
- FF FINISHED FLOOR
- FL FLOW LINE
- FS FINISHED SURFACE
- FG FINISHED GRADE
- SG SUB-GRADE
- INV INVERT ELEVATION
- SW SIDE WALK
- TB TOP OF BERM
- TC TOP OF CURB
- TG TOP OF GRATE
- TW TOP OF WALL
- WM WATER METER

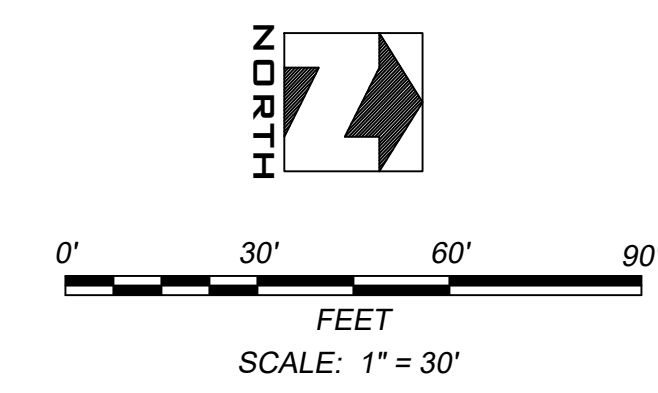

PLAN CHECK CONSULTANT
WILLDAN Engineering
 314 HOLY STREET, SUITE 101
 VENTURA, CALIFORNIA 93001
 (805) 653-6997

PREPARED BY: **M³ CIVIL** CONSULTING CIVIL ENGINEERS
 4000 Calle Teacote, Suite 108
 Camarillo, CA 93012
 (805) 445-4404

JACOB G. LUKIEWSKI DATE
 RCE 71534 EXPIRES: 12/31/2023

REVIEWED:			
DIRECTOR of COMMUNITY DEVELOPMENT	DATE		
REVIEWED:			
DEPUTY DIRECTOR, CAPITAL PROJECTS	DATE		
REVIEWED:			
TRAFFIC ENGINEER	DATE		
REVIEWED:			
MAINTENANCE SUPERINTENDENT	DATE		
REVIEWED:			
DEPUTY DIRECTOR, ENVIRONMENTAL/STORMWATER	DATE		
REVIEWED:			
WATER SUPERINTENDENT	DATE		
REVIEWED:			
WATER RECLAMATION SUPERINTENDENT	DATE		
REV.	DESCRIPTION	APP'D	DATE
DEPARTMENT OF PUBLIC WORKS CITY OF CAMARILLO			
HORIZONTAL CONTROL PLAN CUP-412 KIDSTREAM CHILDREN'S MUSEUM 3100 PONDEROSA DR., CAMARILLO, CA			
DRN BY:	DES BY:	CK'D BY:	
APPROVED:			
CITY ENGINEER		DATE	
DEPARTMENT OF PUBLIC WORKS			
RCE 76459 EXPIRES: 12/31/2024			
RECOMMENDED BY:			
SPEC. NUMBER		PROJ. NUMBER	
F.B.	PG.	SHEET 4 OF 13	C-18403

IMPORTANT NOTICE
 Section 4216/4217 of the Government Code requires a DigAlert Identification Number be issued before a "Permit to Excavate" will be valid. For your DigAlert I.D. Number Call Underground Service Alert
TOLL FREE 811
 Two working days before you dig

UNDERGROUND SERVICE ALERT

CALL BEFORE YOU DIG
 CALL: TOLL FREE 811

TWO WORKING DAYS BEFORE DIGGING

CONSTRUCTION NOTES

1. CONSTRUCT ASPHALT CONCRETE (AC) PAVEMENT, 3" AC OVER 6" AGGREGATE BASE (AB) OVER 12" COMPACTED SUBGRADE, PER SOILS ENGINEER'S RECOMMENDATIONS.
2. CONSTRUCT ADA COMPLIANT CONCRETE DRIVEWAY APRON PER SPPWC 110-2, TYPE A.
3. CONSTRUCT ADA COMPLIANT CONCRETE DRIVEWAY APRON PER SPPWC 110-2, TYPE B.
4. CONSTRUCT CONCRETE CURB AND GUTTER PER SPPWC 120-3, TYPE A2-6, W=18".
5. CONSTRUCT CONCRETE HARDSCAPE, 4" THICK CONCRETE REINFORCED WITH #4 REBAR 24" O.C. OVER 4" SAND OVER 12" COMPACTED SUBGRADE, PER SOILS ENGINEERS RECOMMENDATIONS; COLOR PER ARCH. PLANS.
6. CONSTRUCT 6" CURB PER MODIFIED SPPWC 120-3, TYPE A1-6, CF MAY BE REDUCED TO 4" MIN. TO MATCH EXISTING TOP-OF-CURB AND FINISHED SURFACE ELEVATIONS AS SHOWN ON PLAN; R&R 12" AC FROM CURB FACE.
7. CONSTRUCT 0" CURB AT ADA STALL LOCATIONS AS SHOWN, PROVIDE CURB STOPS FOR EACH STALL ADJACENT TO 0" CURB.
8. INSTALL 6" WIDE CURB CUT OPENINGS, 5' O.C. ALONG ENTIRE LENGTH OF GRASS FILTER STRIP.
9. CONSTRUCT DIAMOND SHAPED PLANTER WITH ADA COMPLIANT TREE GRATE PER ARCHITECT AND LANDSCAPE PLANS.
10. INSTALL LANDSCAPING PER LANDSCAPE PLANS.
11. CONSTRUCT FREE STANDING PRIVACY WALL PER ARCHITECT PLANS.
12. INSTALL 6" DIAMETER WEEP HOLE IN WALL AT LOCATION AND ELEVATION SHOWN.
13. CONSTRUCT PRIVACY FENCE PER ARCHITECT PLANS.
14. INSTALL PARKING STRIPING PER ARCHITECT PLANS.
15. CONSTRUCT ADA COMPLIANT RAMP, MAX. 8% SLOPE, MAX. 2% CROSS SLOPE; WITH CAST-IN-PLACE DETECTABLE WARNING SURFACE, COLOR: FEDERAL NO. 20109.
16. CONSTRUCT ADA COMPLIANT CURB RAMP PER SPPWC 111-5, TYPE 3; WITH CAST-IN-PLACE DETECTABLE WARNING SURFACE, COLOR: FEDERAL NO. 20109.
17. PROVIDE HANDRAIL PER ARCHITECT'S PLAN.
18. CONSTRUCT VEGETATED FILTER STRIP PER DETAIL 18, SHT. 11. OUTLET TO INFILTRATION TRENCH, INSTALL VEGETATION PER LANDSCAPE PLANS.
19. CONSTRUCT 5' WIDE, 1' DEEP, VEGETATED SWALE PER DETAIL 19, SHT. 11, OUTLET TO INFILTRATION TRENCH, INSTALL VEGETATION PER LANDSCAPE PLANS.
20. CONSTRUCT INFILTRATION TRENCH AT LOCATIONS SHOWN, SIZE PER PLAN, PER DETAIL 20, SHT. 11, OVERFLOW TO CONCRETE PARKWAY DRAIN.
21. CONSTRUCT PARKWAY DRAIN PER SPPWC 151-3, S=12".
22. CONSTRUCT 6" TALL EARTHEN BERM AROUND INFILTRATIONS TRENCH.
23. CONSTRUCT REINFORCED CMU RETAINING WALL PER SEPARATE PERMIT. INSTALL 42" WROUGHT IRON FENCING ON TOP OF WALL PER LANDSCAPE PLANS.
24. CONSTRUCT REINFORCED CMU RETAINING WALL WITH 36" HIGH, FREESTANDING CMU VEHICLE BARRIER PER SEPARATE PERMIT.
25. CONSTRUCT 4' WIDE CONCRETE GUTTER. OUTLET THROUGH CURB OPENING TO VEGETATED SWALE AS SHOWN.
26. CONSTRUCT CONCRETE HEADER AROUND FIXED PLAYGROUND SURFACES PER PLAYGROUND LANDSCAPE PLANS, SHT. LS-2.
27. CONSTRUCT CONCRETE PLAYGROUND CURB AROUND LOOSE PLAYGROUND SURFACES PER PLAYGROUND LANDSCAPE PLANS, SHT. LS-2, DETAIL D.
28. CONSTRUCT LOW PLANTER SEAT WALL PER PLAYGROUND LANDSCAPE PLANS, SHT. LS-4, DETAIL A.
29. CONSTRUCT LANDSCAPED BERM, MAX. 2:1 SLOPE PER SOILS ENGINEER'S RECOMMENDATIONS. LANDSCAPING PER PLAYGROUND LANDSCAPE PLANS.
30. INSTALL DECOMPOSED GRANITE (DG) SECTION PER PLAYGROUND LANDSCAPE PLANS, SHT. LS-2 DETAIL B.
31. INSTALL P.I.P SAFETY SURFACING SECTION PER PLAYGROUND LANDSCAPE PLANS, SHT. LS-2 DETAIL C.
32. INSTALL WASHED PLAYGROUND SAND SECTION PER PLAYGROUND LANDSCAPE PLANS, SHT. LS-2 DETAIL D.
33. INSTALL FIBER ENGINEERED WOOD CHIPS SECTION PER PLAYGROUND LANDSCAPE PLANS, SHT. LS-2 DETAIL D.
34. INSTALL ARTIFICIAL TURF SECTION PER PLAYGROUND LANDSCAPE PLANS, SHT. LS-2 DETAIL E.
35. INSTALL PEDESTRIAN CONCRETE PAVER SECTION PER PLAYGROUND LANDSCAPE PLANS, SHT. LS-2 DETAIL F.
36. CONSTRUCT INTEGRAL FLOWLINE IN PLANTER AREA, MINIMUM 0.5% LONGITUDINAL SLOPE.
37. CONSTRUCT TRASH ENCLOSURE PER ARCHITECT'S PLANS.
38. CONSTRUCT 2' WIDE, 6" DEEP CONCRETE CHANNEL WATER PLAY FEATURE PER PLAYGROUND LANDSCAPE PLANS, MIN. 2% LONGITUDINAL SLOPE, SEE PLAYGROUND LANDSCAPE PLANS FOR ROCK AND WEIR PLACEMENT.
39. CONSTRUCT CAST-IN-PLACE DETECTABLE WARNING SURFACE, COLOR: FEDERAL NO. 20109.
40. INSTALL WHEEL STOPS PER ARCHITECT'S PLAN.
41. INSTALL 2" DOMESTIC & IRRIGATION WATER METER PER CITY OF CAMARILLO STD. DETAIL W12.
42. INSTALL 2" BACKFLOW ASSEMBLY ON EXISTING 2" IRRIGATION WATER SERVICE, PER CITY OF CAMARILLO STD. W13.

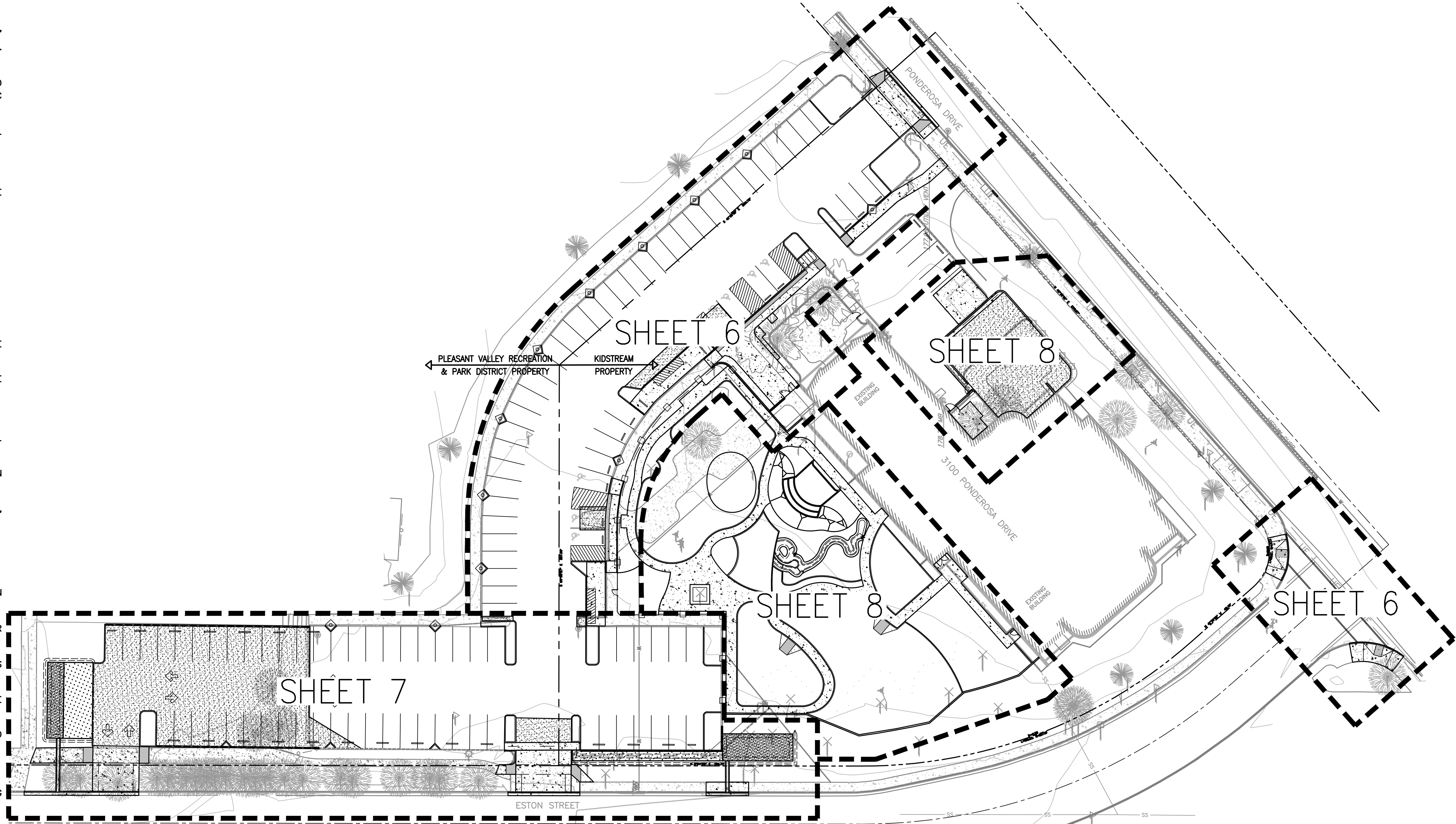

LEGEND

- PROPERTY LINE
- RIGHT-OF-WAY LINE
- CENTER LINE
- PROPOSED RETAINING WALL
- EXISTING BLOCK WALL
- PROPOSED SUBDRAIN LINE
- PROPOSED DRAIN LINE
- PROPOSED DRAIN INLET
- PROPOSED SUMP PUMP WELL
- DIRECTIONAL FLOW ARROW

ABBREVIATIONS

- CONC CONCRETE
- AC ASPHALT CONCRETE PAVEMENT
- BC BOTTOM OF CURB
- C&G CURB AND GUTTER
- CMU CONCRETE MASONRY UNIT WALL
- EG EXISTING GRADE
- EX EXISTING
- FF FINISHED FLOOR
- FL FLOW LINE
- FS FINISHED SURFACE
- FG FINISHED GRADE
- SG SUB-GRADE
- INV INVERT ELEVATION
- SW SIDE WALK
- TB TOP OF BERM
- TC TOP OF CURB
- TG TOP OF GRATE
- TW TOP OF WALL
- WM WATER METER

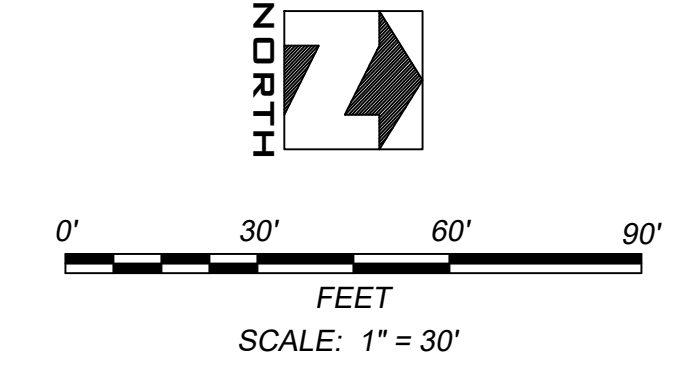

IMPORTANT NOTICE
 Section 4216/4217 of the Government Code requires a DigAlert Identification Number be issued before a "Permit to Excavate" will be valid. For your DigAlert I.D. Number Call Underground Service Alert
TOLL FREE 811
 Two working days before you dig

UNDERGROUND SERVICE ALERT



NOTE: ALL NEW AND EXISTING CATCH BASINS SHALL BE FITTED WITH A FULL TRASH CAPTURE DEVICE.
 NOTE: EXISTING WATER AND SEWER LINES PER "AS-BUILT" DRAINWG DATED SEPT. 6, 1974.

PLAN CHECK CONSULTANT
WILLDAN Engineering
 314 HOLY STREET, SUITE 101
 VENTURA, CALIFORNIA 93001
 (805) 653-6997

PREPARED BY: **M³ CIVIL** CONSULTING CIVIL ENGINEERS
 4000 Calle Tecate, Suite 108
 Camarillo, CA 93012
 (805) 445-4404

JACOB G. LUKIEWSKI
 RCE 71534 EXPIRES: 12/31/2023

REVIEWED:			
DIRECTOR of COMMUNITY DEVELOPMENT	DATE		
REVIEWED:			
DEPUTY DIRECTOR, CAPITAL PROJECTS	DATE		
REVIEWED:			
TRAFFIC ENGINEER	DATE		
REVIEWED:			
MAINTENANCE SUPERINTENDENT	DATE		
REVIEWED:			
DEPUTY DIRECTOR, ENVIRONMENTAL/STORMWATER	DATE		
REVIEWED:			
WATER SUPERINTENDENT	DATE		
REVIEWED:			
WATER RECLAMATION SUPERINTENDENT	DATE		

REV.	DESCRIPTION	APP'D	DATE
DEPARTMENT OF PUBLIC WORKS CITY OF CAMARILLO GRADING PLAN OVERVIEW & CONSTRUCTION NOTES CUP-412 KIDSTREAM CHILDREN'S MUSEUM 3100 PONDEROSA DR., CAMARILLO, CA			
DRN BY:	DES BY:	CK'D BY:	
APPROVED:			
CITY ENGINEER	DATE		
DEPARTMENT OF PUBLIC WORKS			
RCE 76459	EXPIRES: 12/31/2024		
RECOMMENDED BY:			
SPEC. NUMBER	PROJ. NUMBER		
F.B.	PG.	SHEET 5 OF 13	C-18404

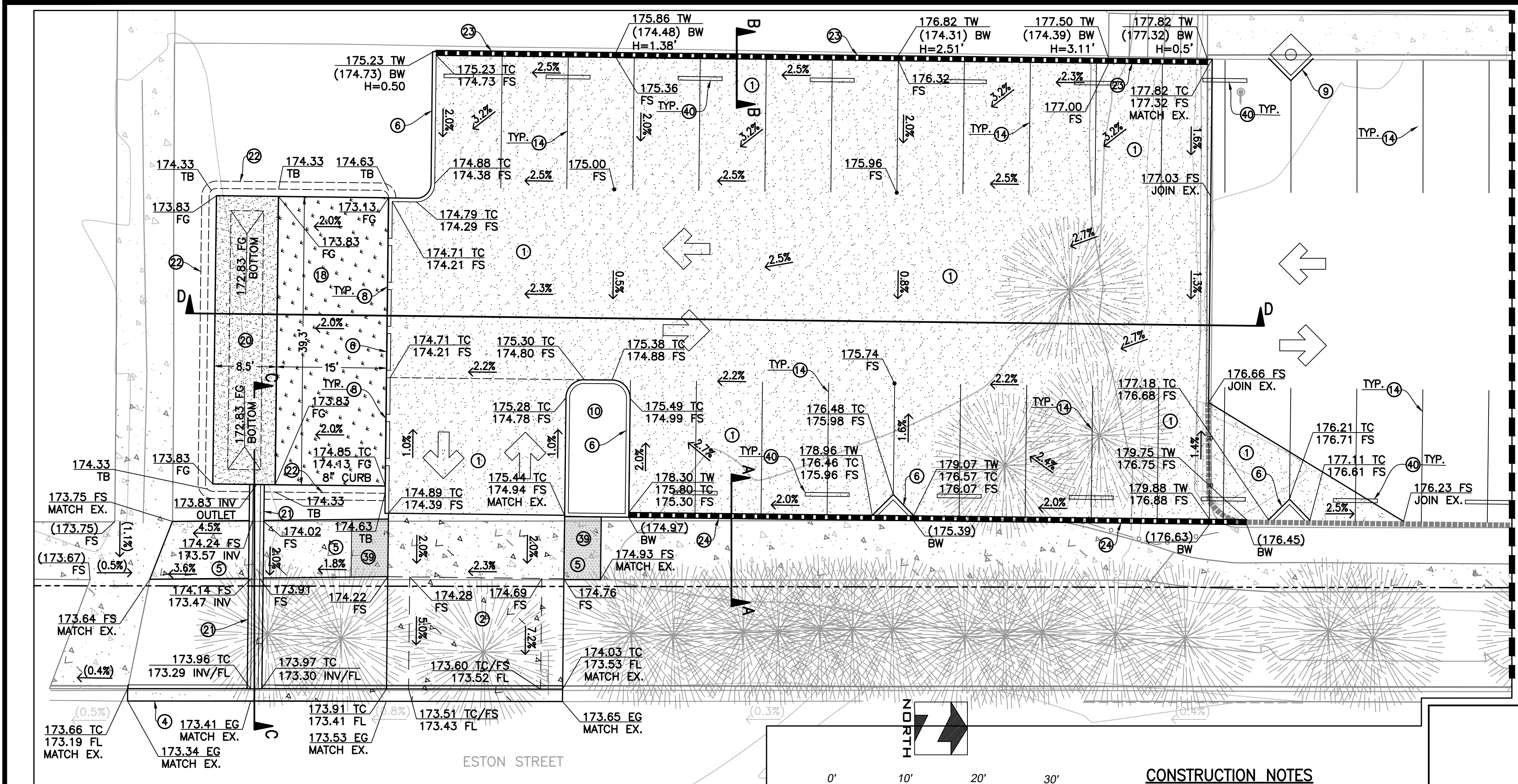

LEGEND		ABBREVIATIONS		UNDERGROUND SERVICE ALERT
	PROPERTY LINE	CONC	CONCRETE	 CALL BEFORE YOU DIG CALL: TOLL FREE 1-800-485-3111
	RIGHT-OF-WAY LINE	AC	ASPHALT CONCRETE PAVEMENT	
	CENTER LINE	BC	BOTTOM OF CURB	
	PROPOSED RETAINING WALL	C&G	CURB AND GUTTER	
	EXISTING BLOCK WALL	CMU	CONCRETE MASONRY UNIT WALL	
	PROPOSED SUBDRAIN LINE	EG	EXISTING GRADE	
	PROPOSED DRAIN LINE	EX	EXISTING FINISHED FLOOR	
	PROPOSED DRAIN INLET	FL	FINISHED FLOOR	
	PROPOSED SUMP PUMP WELL	FS	FINISHED SURFACE	
	DIRECTIONAL FLOW ARROW	FG	FINISHED GRADE	
		SG	SUB-GRADE	
		INV	INVERT ELEVATION	
		SW	SIDE WALK	
		TB	TOP OF BERM	
		TC	TOP OF CURB	
		TG	TOP OF GRATE	
		TW	TOP OF WALL	
		WM	WATER METER	

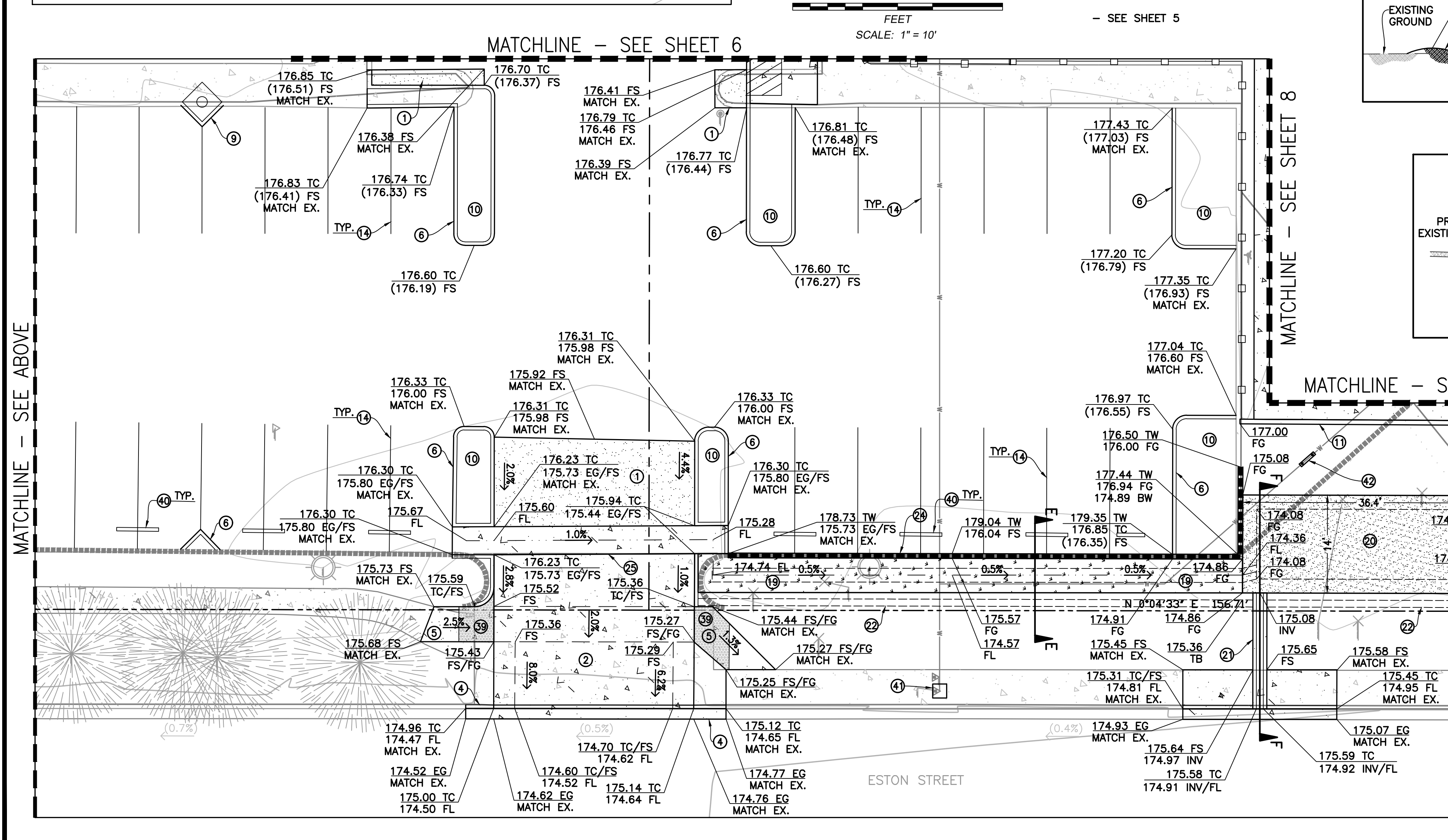
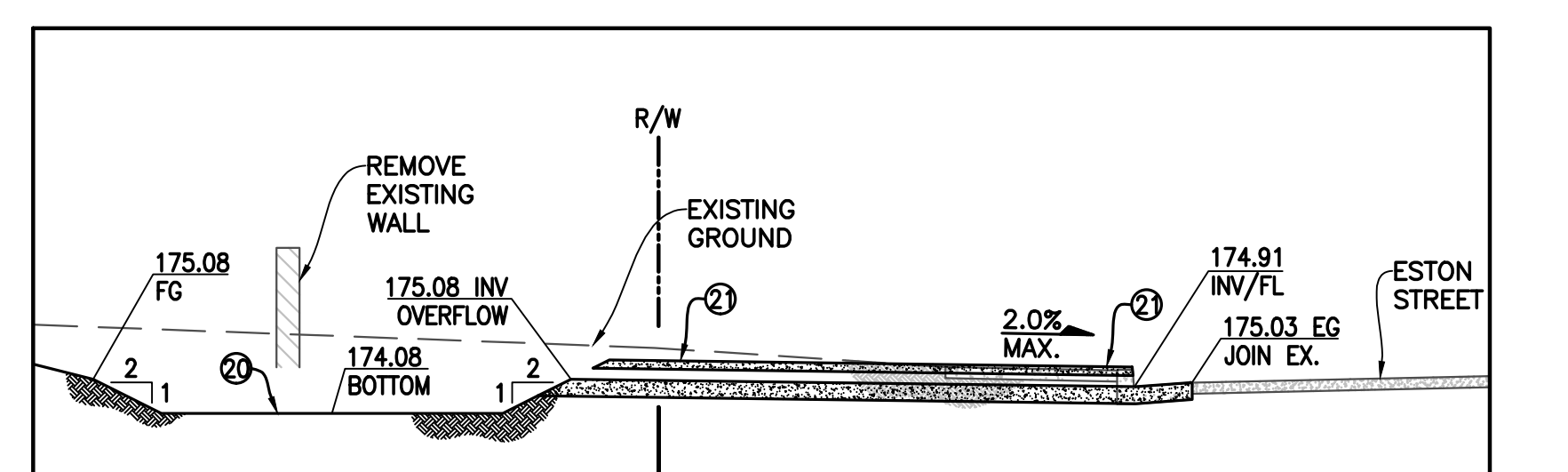
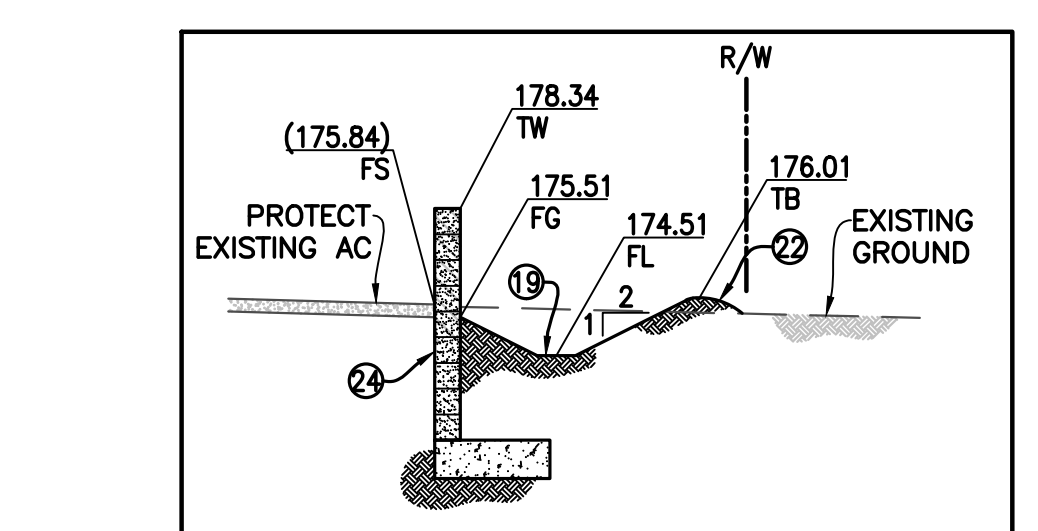
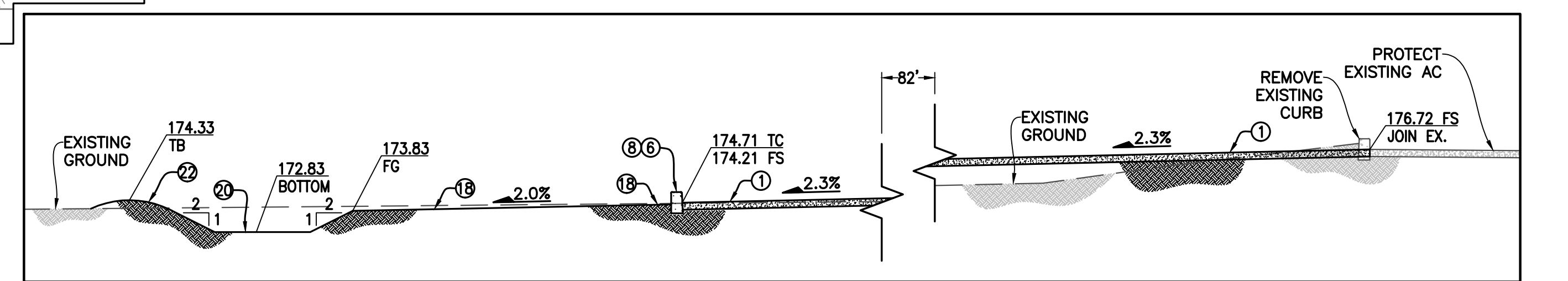
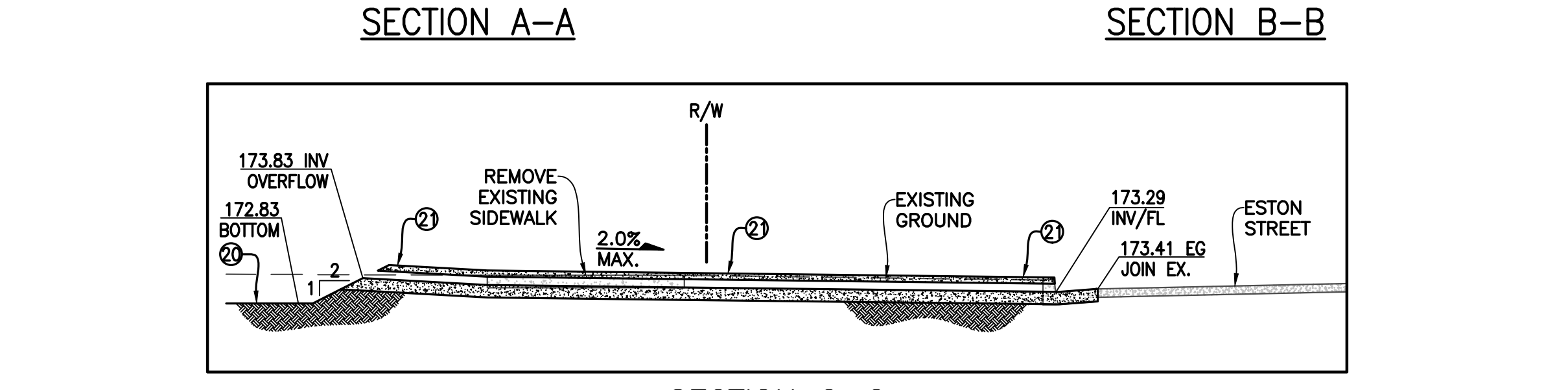
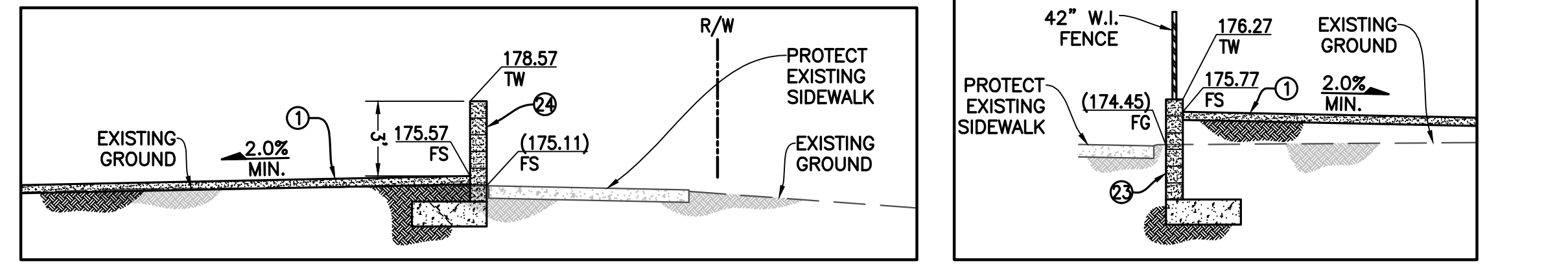

CONSTRUCTION NOTES
- SEE SHEET 5

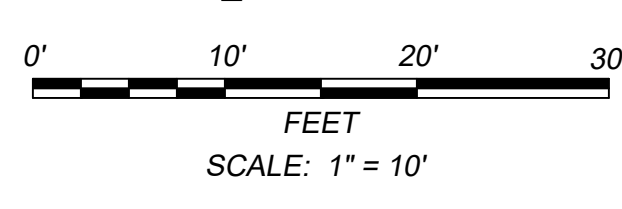

PLAN CHECK CONSULTANT
WILLDAN Engineering
314 HOLLY STREET, SUITE 101
VENTURA, CALIFORNIA 93001
(805) 653-6997

PREPARED BY:
M³ CIVIL
Consulting Civil Engineers
4000 Calle Teate, Suite 108
Camarillo, CA 93012
(805) 445-4404

JACOB G. LUKIEWSKI
RCE 71534
EXPIRES: 12/31/2023

JOB NO. 19.00
DATE

REVIEWED:	DATE		
DIRECTOR of COMMUNITY DEVELOPMENT	DATE		
REVIEWED:	DATE		
DEPUTY DIRECTOR, CAPITAL PROJECTS	DATE		
REVIEWED:	DATE		
TRAFFIC ENGINEER	DATE		
REVIEWED:	DATE		
MAINTENANCE SUPERINTENDENT	DATE		
REVIEWED:	DATE		
DEPUTY DIRECTOR, ENVIRONMENTAL/STORMWATER	DATE		
REVIEWED:	DATE		
WATER SUPERINTENDENT	DATE		
REVIEWED:	DATE		
WATER RECLAMATION SUPERINTENDENT	DATE		

REV.	DESCRIPTION	APP'D	DATE

DEPARTMENT OF PUBLIC WORKS
CITY OF CAMARILLO

FINE GRADING PLAN - 2
CUP-412
KIDSTREAM CHILDREN'S MUSEUM
3100 PONDEROSA DR., CAMARILLO, CA

DRN BY: DES BY: CK'D BY:

APPROVED:

CITY ENGINEER
DEPARTMENT OF PUBLIC WORKS
RCE 76459
EXPIRES: 12/31/2024

SPEC. NUMBER PROJ. NUMBER
F.B. PG. SHEET 7 OF 13 C-18406

CONSTRUCTION NOTES

1. REMOVE EXISTING DRIVEWAY APRON AND CONSTRUCT ADA COMPLIANT CONCRETE DRIVEWAY APRON PER SPPWC 110-2, TYPE A.
2. REMOVE EXISTING DRIVEWAY APRON AND CONSTRUCT ADA COMPLIANT CONCRETE DRIVEWAY APRON PER SPPWC 110-2, TYPE B.
3. REMOVE AND RECONSTRUCT CONCRETE CURB AND GUTTER PER SPPWC 120-3, TYPE A2-6, W=18".
4. REMOVE AND RECONSTRUCT CONCRETE SIDEWALK TO MATCH EXISTING.
5. SAWCUT, REMOVE, & REPLACE 2'-WIDE AC PAVEMENT & BASE MATERIAL TO MATCH EXISTING.
6. INSTALL LANDSCAPING PER LANDSCAPE PLANS.
7. CONSTRUCT ADA COMPLIANT CURB RAMP PER SPPWC 111-5, TYPE 3.
8. CONSTRUCT PARKWAY DRAIN PER SPPWC 151-3, S=12".

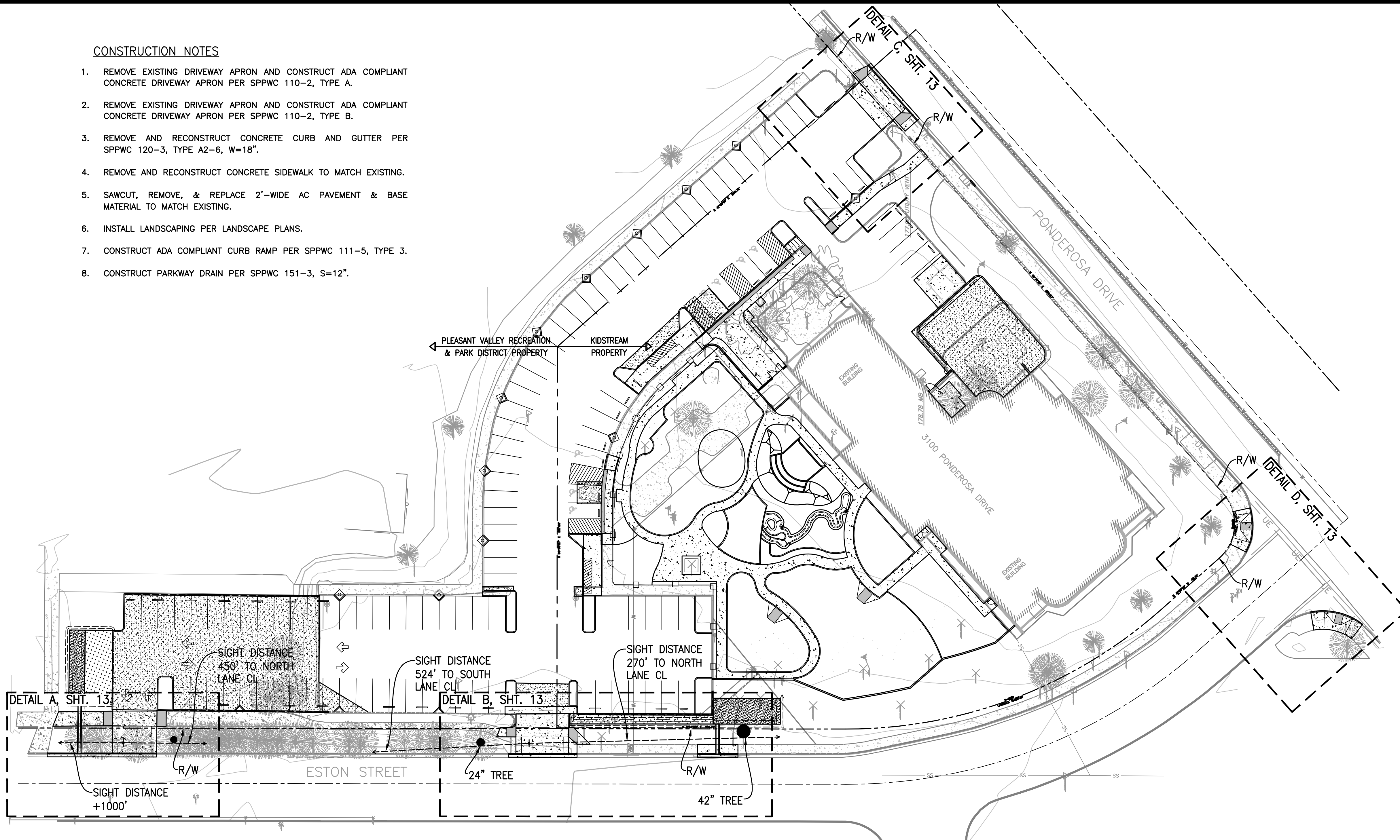

NOTE:

1. SIDEWALK AND RAMP SLOPES SHOWN ARE MAXIMUM ALLOWABLE. ALL SLOPES TO BE VERIFIED IN FIELD PRIOR TO PLACEMENT OF CONCRETE.
2. PER CITY APPROVAL LETTER DATED DECEMBER 6, 2022, STREETS CONDITION NUMBER 9B, ESTON STREET IS IN MORATORIUM. IF PAVEMENT IS DISTURBED/CUT IN ANY MANNER DURING CONSTRUCTION, THEN PAVEMENT MUST BE SLURRY SEALED (TYPE II) OR OVERLAYED AS DETERMINED BY THE CIP DIVISION AND MUST INCLUDE ALL PREPARATORY WORK. SLURRY SEAL OR OVERLAY LIMITS MAY INCLUDE UP TO FULL ROADWAY WIDTH ALONG THE ENTIRE PROPERTY FRONTAGE.

LEGEND

- PROPERTY LINE
- - - RIGHT-OF-WAY LINE
- - - CENTER LINE
- PROPOSED RETAINING WALL
- EXISTING BLOCK WALL
- PROPOSED SUBDRAIN LINE
- PROPOSED DRAIN LINE
- PROPOSED DRAIN INLET
- PROPOSED SUMP PUMP WELL
- DIRECTIONAL FLOW ARROW
- 2.5% SLOPE

ABBREVIATIONS

- CONC CONCRETE
- AC ASPHALT CONCRETE PAVEMENT
- BC BOTTOM OF CURB
- C&G CURB AND GUTTER
- CMU CONCRETE MASONRY UNIT WALL
- EG EXISTING GRADE
- EX EXISTING
- FF FINISHED FLOOR
- FL FLOW LINE
- FS FINISHED SURFACE
- FG FINISHED GRADE
- SG SUB-GRADE
- INV INVERT ELEVATION
- SW SIDE WALK
- TB TOP OF BERM
- TC TOP OF CURB
- TG TOP OF GRATE
- TW TOP OF WALL
- WM WATER METER

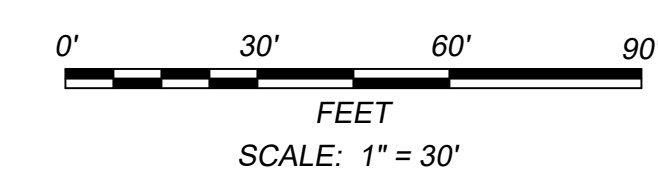

PLAN CHECK CONSULTANT
WILLDAN Engineering
 374 HOLY STREET, SUITE 101
 VENTURA, CALIFORNIA 93001
 (805) 653-6997

PREPARED BY: **M³ CIVIL**
 Consulting Civil Engineers
 4000 Calle Tecate, Suite 108
 Camarillo, CA 93012
 (805) 445-4404

JACOB G. LUKIEWSKI
 RCE 71534 EXPIRES: 12/31/2023

REVIEWED:			
DIRECTOR of COMMUNITY DEVELOPMENT	DATE		
REVIEWED:			
DEPUTY DIRECTOR, CAPITAL PROJECTS	DATE		
REVIEWED:			
TRAFFIC ENGINEER	DATE		
REVIEWED:			
MAINTENANCE SUPERINTENDENT	DATE		
REVIEWED:			
DEPUTY DIRECTOR, ENVIRONMENTAL/STORMWATER	DATE		
REVIEWED:			
WATER SUPERINTENDENT	DATE		
REVIEWED:			
WATER RECLAMATION SUPERINTENDENT	DATE		

REV.	DESCRIPTION	APP'D	DATE

DEPARTMENT OF PUBLIC WORKS
CITY OF CAMARILLO

STREET PLAN OVERVIEW
 CUP-412
 KIDSTREAM CHILDREN'S MUSEUM
 3100 PONDEROSA DR., CAMARILLO, CA

DRN BY:	DES BY:	CK'D BY:

APPROVED:

CITY ENGINEER	DATE
DEPARTMENT OF PUBLIC WORKS	
RCE 76459 EXPIRES: 12/31/2024	

RECOMMENDED BY:

SPEC. NUMBER	PROJ. NUMBER

F.B. PG. SHEET 12 OF 13 C-18411

IMPORTANT NOTICE
 Section 4216/4217 of the Government Code requires a DigAlert Identification Number be issued before a "Permit to Excavate" will be valid. For your DigAlert I.D. Number Call Underground Service Alert
TOLL FREE 811
 Two working days before you dig

UNDERGROUND SERVICE ALERT
 CALL BEFORE YOU DIG
 CALL: TOLL FREE 811
 TWO WORKING DAYS BEFORE DIGGING

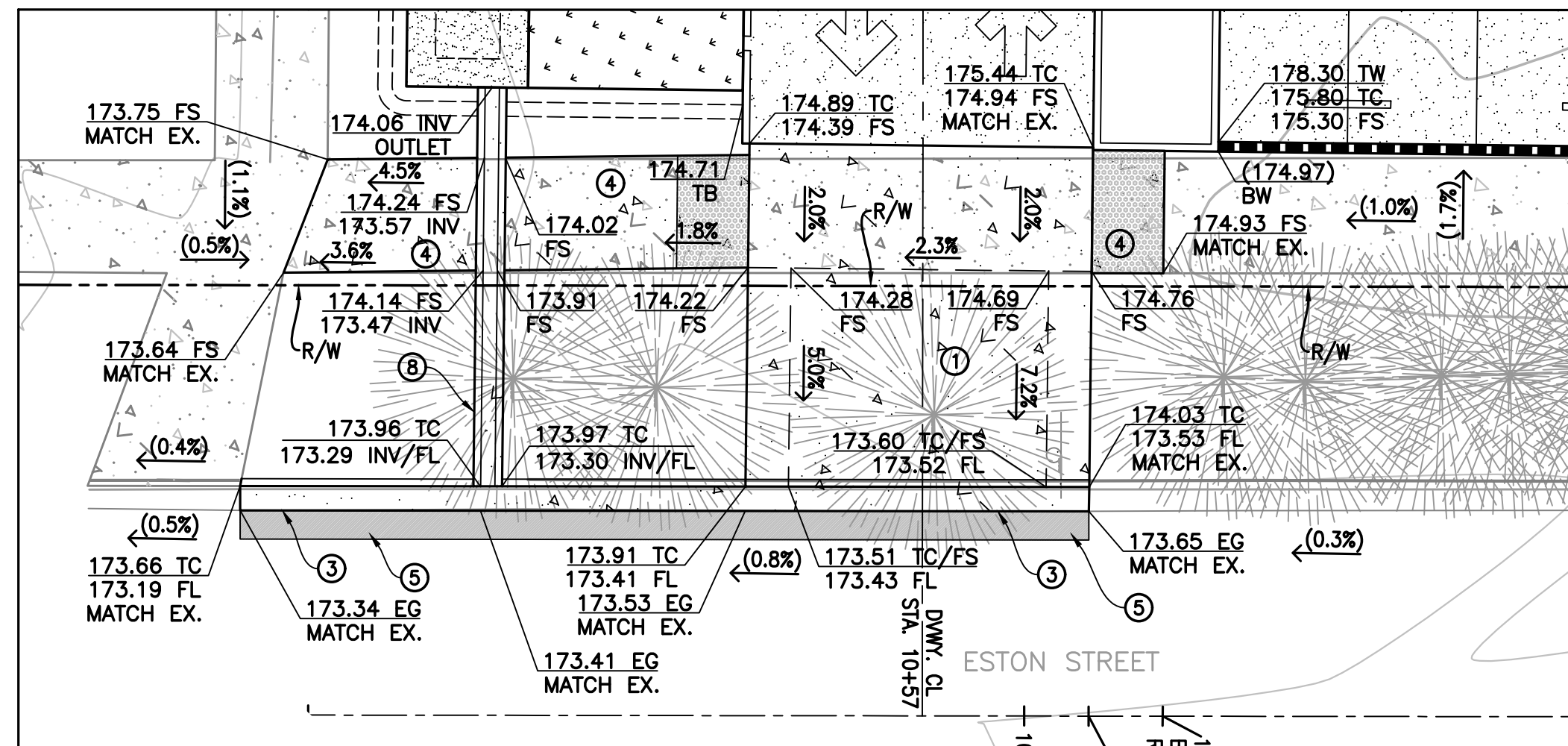

DETAIL "A"
SCALE: 1"=10'

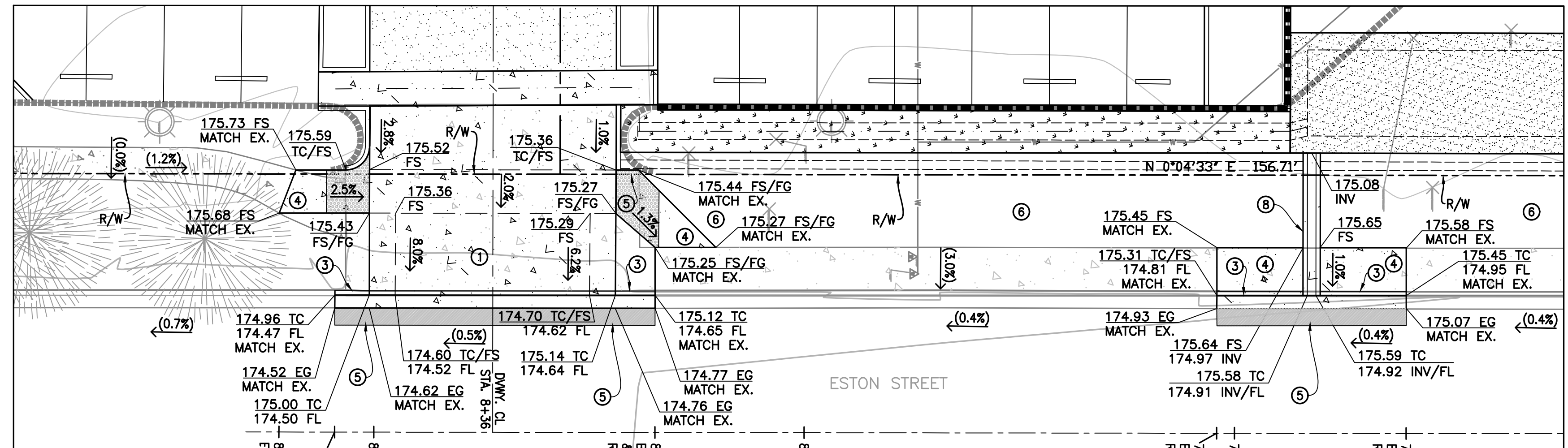
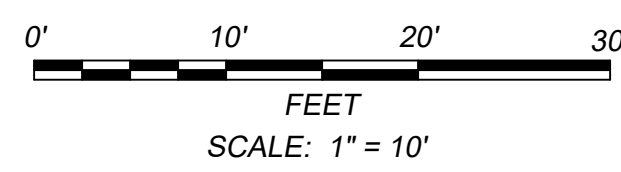
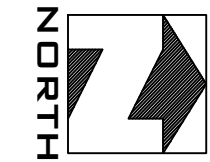

DETAIL "B"
SCALE: 1"=10'

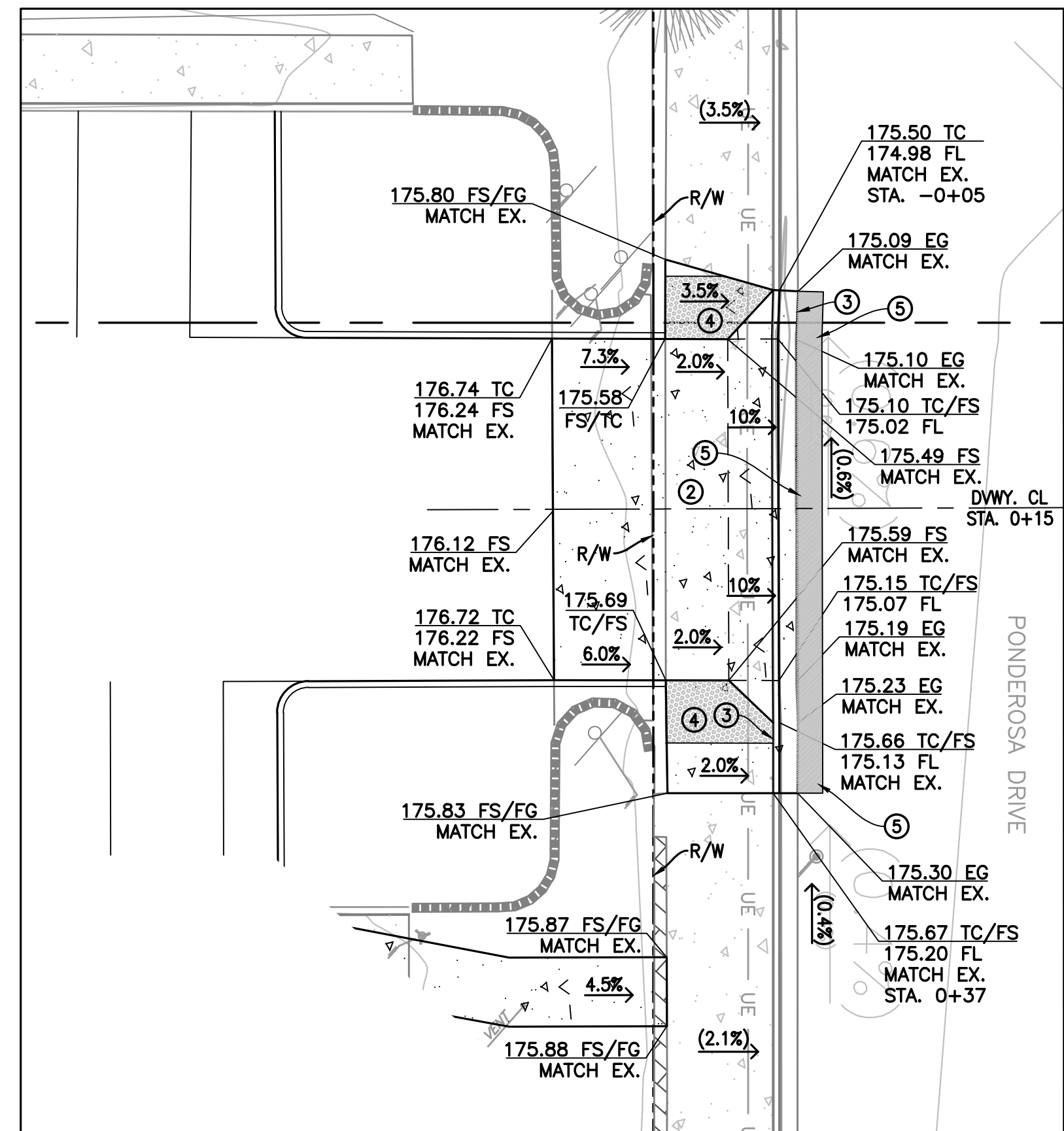
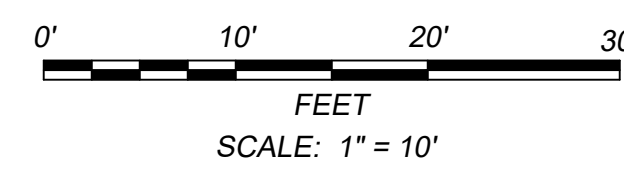
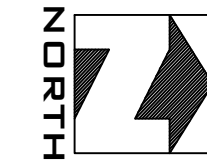

DETAIL "C"
SCALE: 1"=10'

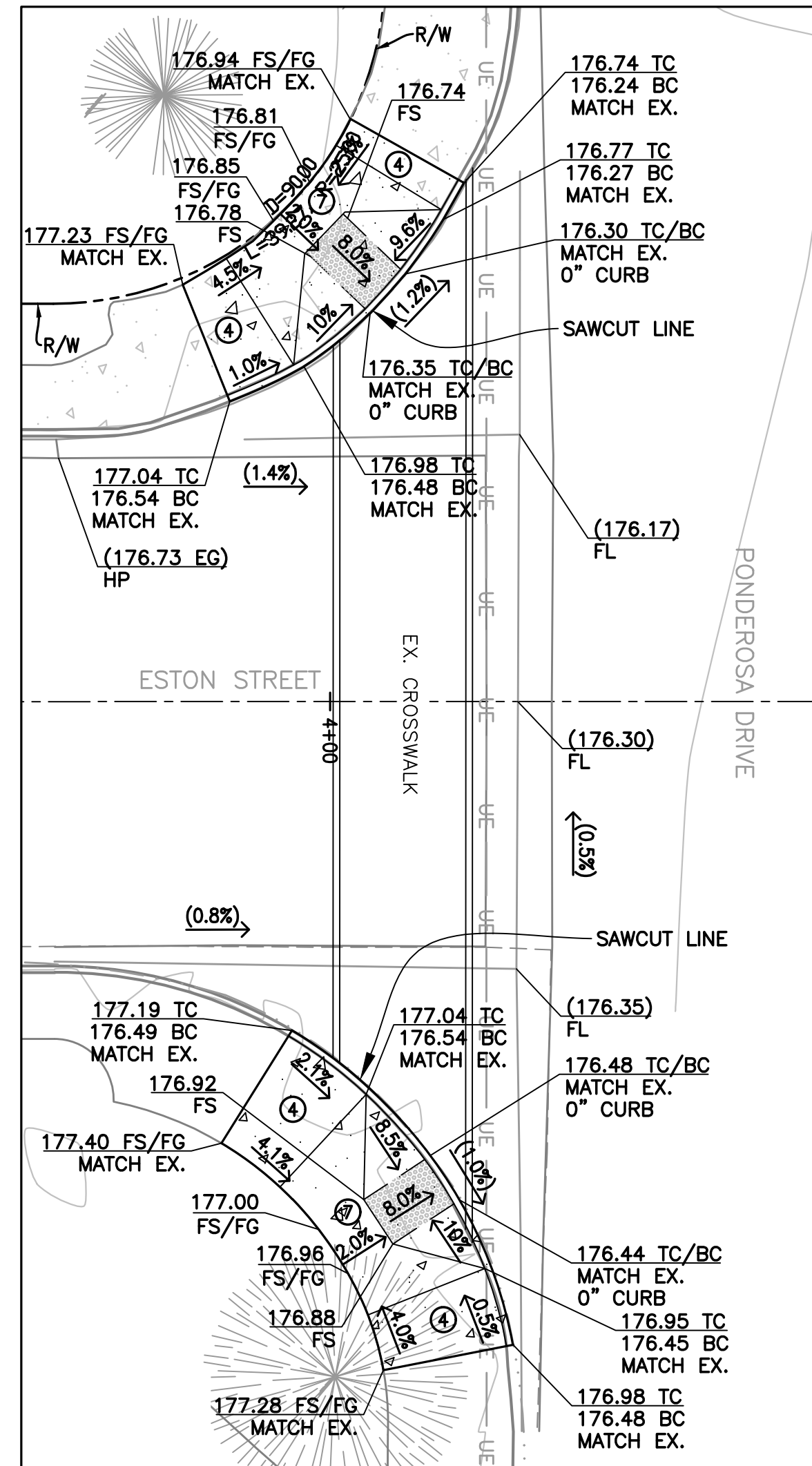
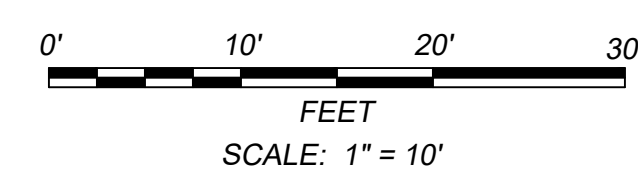

DETAIL "D"
SCALE: 1"=10'

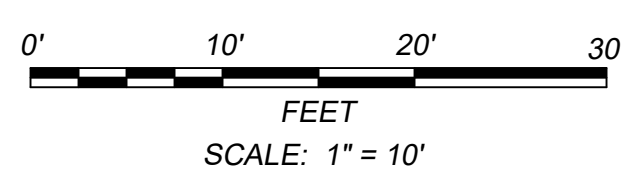

CONSTRUCTION NOTES

1. REMOVE EXISTING DRIVEWAY APRON AND CONSTRUCT ADA COMPLIANT CONCRETE DRIVEWAY APRON PER SPPWC 110-2, TYPE A.
2. REMOVE EXISTING DRIVEWAY APRON AND CONSTRUCT ADA COMPLIANT CONCRETE DRIVEWAY APRON PER SPPWC 110-2, TYPE B.
3. REMOVE AND RECONSTRUCT CONCRETE CURB AND GUTTER PER SPPWC 120-3, TYPE A2-6, W=18".
4. REMOVE AND RECONSTRUCT CONCRETE SIDEWALK TO MATCH EXISTING.
5. SAWCUT, REMOVE, & REPLACE 2'-WIDE AC PAVEMENT & BASE MATERIAL TO MATCH EXISTING.
6. INSTALL LANDSCAPING PER LANDSCAPE PLANS.
7. CONSTRUCT ADA COMPLIANT CURB RAMP PER SPPWC 111-5, TYPE J.
8. CONSTRUCT PARKWAY DRAIN PER SPPWC 151-3, S=12".

LEGEND

- PROPERTY LINE
- - - RIGHT-OF-WAY LINE
- - - CENTER LINE
- - - PROPOSED RETAINING WALL
- - - EXISTING BLOCK WALL
- - - PROPOSED SUBDRAIN LINE
- - - PROPOSED DRAIN LINE
- ⊕ PROPOSED DRAIN INLET
- ⊕ PROPOSED SUMP PUMP WELL
- 2.5% DIRECTIONAL FLOW ARROW

ABBREVIATIONS

- CONC CONCRETE
- AC ASPHALT CONCRETE PAVEMENT
- BC BOTTOM OF CURB
- C&G CURB AND GUTTER
- CMU CONCRETE MASONRY UNIT WALL
- EG EXISTING GRADE
- EX EXISTING FLOOR
- FF FINISHED FLOOR
- FL FLOW LINE
- FS FINISHED SURFACE
- FG FINISHED GRADE
- SG SUB-GRADE
- INV INVERT ELEVATION
- SW SIDE WALK
- TB TOP OF BERM
- TC TOP OF CURB
- TG TOP OF GRATE
- TW TOP OF WALL
- WM WATER METER

PLAN CHECK CONSULTANT

 314 HOLI STREET, SUITE 101
 VENTURA, CALIFORNIA 93001
 (805) 653-6597

PREPARED BY:

 Consulting Civil Engineers
 4000 Calle Teocate, Suite 108
 Camarillo, CA 93012
 (805) 445-4404

JACOB G. LUKIEWSKI
 RCE 71534 EXPIRES: 12/31/2023

REVIEWED:	DATE		
DIRECTOR of COMMUNITY DEVELOPMENT	DATE		
REVIEWED:	DATE		
DEPUTY DIRECTOR, CAPITAL PROJECTS	DATE		
REVIEWED:	DATE		
TRAFFIC ENGINEER	DATE		
REVIEWED:	DATE		
MAINTENANCE SUPERINTENDENT	DATE		
REVIEWED:	DATE		
DEPUTY DIRECTOR, ENVIRONMENTAL/STORMWATER	DATE		
WATER SUPERINTENDENT	DATE		
REVIEWED:	DATE		
WATER RECLAMATION SUPERINTENDENT	DATE		

REV.	DESCRIPTION	APP'D	DATE
DEPARTMENT OF PUBLIC WORKS CITY OF CAMARILLO STREET PLAN CUP-412 KIDSTREAM CHILDREN'S MUSEUM 3100 PONDEROSA DR., CAMARILLO, CA			
DRN BY:	DES BY:	CK'D BY:	
APPROVED:			
CITY ENGINEER	DATE		
DEPARTMENT OF PUBLIC WORKS			
RCE 76459	EXPIRES: 12/31/2024		
RECOMMENDED BY:			
SPEC. NUMBER	PROJ. NUMBER		
F.B.	PG.	SHEET 13 OF 13	C-18412

**PLEASANT VALLEY RECREATION AND PARK DISTRICT
STAFF REPORT / AGENDA REPORT**

TO: BOARD OF DIRECTORS

FROM: MARY OTTEN, GENERAL MANAGER
By: Matthew Parker, Park Services Manager

DATE: May 1, 2024

**SUBJECT: CONSIDERATION AND APPROVAL OF THE DESIGN
OF THE PLAYGROUND AND FITNESS EQUIPMENT
FOR LOKKER PARK**

SUMMARY

As part of the District's efforts to commit and adhere to replacing aging and/or obsolete playgrounds and infrastructure, Staff earmarked \$500,000 from the General Fund for this capital improvement project. Installation of the playgrounds and fitness equipment were installed in 2003, which now require replacement due to exceeding their life expectancy and failing standards as well as the surrounding amenities and walkways. Staff has worked with architectural designers Jordan and Bain Landscape Architects, Inc. to conduct three public meetings to gather feedback to incorporate in the design of three different options for the Board to choose from.

BACKGROUND

Lokker Park is a 7-acre neighborhood park developed in two phases, with the first phase of 3 acres completed in 1994 and the remaining 4 acres in 1997. The park features various amenities such as basketball and sand volleyball courts, horseshoe pits, and walking paths, making it popular among community members. It also includes two (2) playgrounds, one for 2-5 years of age and another for 5-12 years of age, incorporated with some fitness elements for all ages. However, these amenities have surpassed their typical lifespan and do not meet current ADA accessibility standards. Additionally, the surrounding concrete walkways have become hazardous due to tree root expansion.

As part of the playground replacement plan, Lokker Park's playgrounds were identified for replacement in the FY 2023-2024 Capital Improvement Projects Budget with an allocation of \$500,000.

Due to the current site conditions and complexities surrounding the inclusion of ADA accessibility compliancy into this project, the District sought out professional Landscape Architectural services to help navigate all of the code requirements, develop and design construction plans for site improvements and the playground replacement. A Request for Proposal for Architectural Services was issued in September of 2023 and the District received three bids from Lauterbach & Associates, Jordan & Bain Landscape Architects, Inc., and RRM Design Group. Jordan & Bain was selected and entered into agreement with the District in November 2023.

The project scope encompasses various stages crucial for the successful renovation of Lokker Park's playgrounds. Initially, project initiation involved meeting with District staff to outline intentions, initiate planning procedures and budget review. This phase also included a thorough review and analysis of existing site conditions along with the evaluation of potential site elements. The deliverables at this stage included the Final Scope of Services and Project Schedule. Moving forward, the conceptual design phase refines the proposed elements, producing detailed site plans, elevations, and colored renderings for approval and construction document preparation. Deliverables for this phase encompass the Final Conceptual Design, Construction Cost Estimates, and Stamped Construction Ready Plans. Throughout the process, presentations and meetings play a pivotal role, requiring attendance at multiple staff and community gatherings for design review and public input. Finally, a PowerPoint presentation is prepared and presented to the District Board of Directors for final design approval.

ANALYSIS

The District collaborated with Jordan & Bain Landscape Architects and Cathy Wiggins of Park and Play Structures to host a series of three community meetings aimed at involving residents in the project planning phase. The inaugural Kick Off Meeting took place at Lokker Park on Saturday, January 13, 2024, to introduce the project to the park's neighbors. Subsequently, the second meeting occurred on Tuesday, January 30, 2024, at the Senior Center, where the Conceptual Plan was presented, and further community feedback was collected. The final Concept Presentation was held on February 13, 2024, also at the Senior Center, during which John Bain and Cathy Wiggins unveiled the ultimate design of the playground and exercise equipment. Throughout these gatherings, community members actively shared their ideas and preferences regarding the project's elements and features. Leveraging this valuable input, the team developed three distinct design options for the Board of Directors to review and deliberate upon. Given the significant need for repairs to the concrete walkway infrastructure and the confines of the designated budget, these design options were meticulously crafted to facilitate comprehensive evaluation and decision-making by the Board.

To obtain approval from the City of Camarillo, the project must adhere to accessibility codes. Achieving compliance involves significant site work, referred to as the "Base Bid," estimated at \$121,543.00. This includes the following:

- Demolition of 5,137 square feet of compromised concrete.
- Replacement of 4,066 square feet of concrete sidewalk.
- Installation of a concrete mow strip (upper area) spanning 65 linear feet.
- Removal of two (2) trees that obstruct pathway lighting and create a pinch-point along the pathway.
- Root pruning for trees that are remaining.
- Replacement of irrigation system for the remaining trees.
- Purchase and install four (4) new benches (required).
- Provision of temporary chain link fencing for the duration of construction, including a 90-day maintenance period.

Regardless of the selection of the various options of playgrounds, the "Base Bid" remains fixed and will be added to the cost of whichever playground option is selected.

Itemized Pricing found in Attachments #1-3:

Options	Description	Cost
1 "Primary"	This option offers a spectrum of features, playability, and inclusivity. Has a 3- bay swing set for all abilities and includes some natural like features such as tree stumps tree slices step stones. Also includes five (5) benches. *This option does not include the fitness equipment stations and the upper play area will only contain sand.	\$443,549
2 "Secondary"	This option has all that features #1 has to offer but includes five (5) fitness equipment pieces placed throughout the park and the upper play/science area will include a District owned repurposed ant hill climber feature and some balancing elements.	\$546,099
3 "Deluxe"	This option has all the same features that option #2 has to offer but incorporates more of the natural-like reinforced concrete features such as a treehouse platform on the 5-12yr. old play structure, fallen tree balance beam, stepping boulders and tree tunnel crawl.	\$586,008

All options offer a spectrum of features and playability, warranting considerations for the Board to weigh while considering factors such as budget, community preferences, and the overall vision for the project.

In addition to the provided options, District Staff has pledged to contribute to cost reduction efforts by undertaking tasks such as demolishing the existing playground structure and clearing the area of grass and sand. This proactive commitment from the staff further supports the Board's considerations and enhances the overall feasibility of the project. This effort by the staff would result in significant cost savings of \$35,575 for option #1 and \$44,550 for options #2 and #3, providing valuable financial benefits across all proposed alternatives.

FISCAL IMPACT

The District allocated \$500,000 from the General Fund for this Design and Construction project; these funds were designated in the FY 2023-2024 Capital Improvement Projects budget. The cost for the scoped Architectural Design Services approved in November 2023 is a total of \$45,632, leaving the total remaining project balance at **\$454,368**. Taking this into consideration, the cost impact of each option changes to the following:

Option #	Design Cost	Base Bid Cost	Option Cost	In-House Demo Savings	TOTAL EST. COST
1	\$45,632	\$121,543	\$443,549	\$(35,575)	\$575,149 <i>(\$75,149)</i>
2	\$45,632	\$121,543	\$546,099	\$(44,550)	\$668,724 <i>(\$168,724)</i>
3	\$45,632	\$121,543	\$586,008	\$(44,550)	\$708,633 <i>(\$208,633)</i>

Based on the total costs, Staff is recommending selecting Option 1, the “Primary” option for approval. The total cost will require an additional \$75,149 beyond the project budget.

STRATEGIC PLAN COMPLIANCE

Meets 2021 Strategic Plan Goal and Strategy:

- 3.1: Renovate and modernize existing parks and recreation facilities to ensure all parks provide an adequate range and supply of active leisure facilities to meet the growth and diversity in population, programming trends, and new design standards.

RECOMMENDATION

It is recommended that the Board of Directors approve Design Option #1 for playground replacement and site enhancements at Lokker Park.

ATTACHMENTS

- 1) Option 1 – Lokker Park 821-164308G (4 pages)
- 2) Option 2 – Lokker Park 821-164308H (4 pages)
- 3) Option 3 – Lokker Park 821-164308I (4 pages)



Play & Park Structures of Central Coast CA
 2390 C #170 Los Posas Rd.
 Camarillo, CA, 93010
 Phone: 661-964-7626
 Fax:
 Email:
 kathy.wiggins@playandpark.com
 Contact: Kathy Wiggins

Lokker Park

Pleasant Valley Recreation & Park
 Attn: Nick Marienthal
 1605 E. Burnley Street
 Camarillo, CA 93010
 Phone: 805-482-5396
 nmarienthal@pvprpd.org

Quote Number: 821-1643081
 Quote Date: 4/1/2024

Stock ID	Description	Quantity	Weight	Unit Price	Amount
RDU	CUSTOM 5-12 SUPERMAX STRUCTURE	1	9983.97	\$202,704.00	\$202,704.00
	71031 -- RING CLAMP ASSEMBLY	109			
	71532 -- HALF HEX SLAT ROOF W/EXT	2			
	71419 -- SIGN LANGUAGE PANEL	1			
	71348 -- SEAT FOR TWO AND TABLE	1			
	71003 -- SEMI-HEX DECK	4			
	71308 -- CABLE SWAY LINK	1			
	71774 -- ISOSCELES FABRIC SHADE	2			
	72159 -- SUPERMAX 10' x 10' SHADE 1'- 6'	1			
	71370 -- ANGLED ROCK	1			
	60061 -- SMALL KICKPLATE-8"SPACE	2			
	71300 -- VERT ACCESS LADDER 4'-0"	1			
	71385 -- BALCONY DECK	2			
	71344 -- RAIN WHEEL	1			
	71395 -- MINI PANEL	1			
	7202 -- ECHO CHAMBER ASSEMBLY	1			
	71346 -- SINGLE SEAT	1			
	71403 -- SPIN & WIN PANEL	1			
	71013 -- METAL HANDHOLD BARRIER	2			
	71186 -- HORIZ LOOP LADDER-ATTACH	1			
	60645 -- DECK CURB	1			
	71425 -- DRUM LINE	1			
	7357 -- 20" TWO SIDED PACHINKO	1			
	72066 -- INTERACTIVE SENSOR PANEL	1			
	71317 -- SINGLE U-HANDLE	2			
	60172 -- LARGE KICKPLATE-16"DECK	1			
	71680 -- DOUBLE VELOCITY 2'-8"	1			
	71464 -- SLIDE TRANSFER	1			
	71968 -- Shop Panel	1			
	71249 -- BENCH SEAT	1			
	71664 -- 4'-0"ZIP STEP CLIMBER	1			
	71139 -- MESH BARRIER PANEL	1			
	71338 -- HAND PEDALER	1			
	71002 -- ISOSCELES DECK	3			
	71162 -- HORIZ LOOP LADDER-LINK	1			
	71001 -- TRIANGLE DECK	2			
	72127 -- 16" Rise, 4' Span ZEPHYR LINK	1			
	60062 -- SMALL KICKPLATE	1			
	71017 -- RAMP DECK TO DECK	1			
	71015 -- RAMP DECK TO GROUND	1			
	72043 -- SM TRAPEZOID DECK	2			
	71531 -- CLUB HOUSE CLIMBER	1			
	72021 -- SUMMIT CLIMBER 8' - 0"	1			
	71645 -- SPY BARRIER	1			
	71903 -- LONG EXIT SECTION	1			
	71675 -- CURVE LEFT SECTION	1			
	71715 -- 2'STRAIGHT SECTION	1			

	71678 -- SLIDE SUPPORT	1			
	71897 -- DUELLING CRISS-CROSS CASCADE	1			
	71475 -- DECK TO DECK STAIR 4'-0"	1			
	60059 -- 5"OD ALUM UPR 10'W/CAP	6			
	60949 -- 5"OD ALUM UPR 7' W/CAP	5			
	60178 -- 5"OD ALUM UPR 8' W/CAP	1			
	60948 -- 5"OD ALUM UPR 11' W/CAP	2			
	61540 -- 5"OD ALUM UPR 4'W/O CAP	1			
	60041 -- 13'POST W/O CAP ALUM	4			
	G60944 -- 5"OD GALV UPR 15'W/O CAP	3			
	G60042 -- 5"OD UPR GALV 168"W/O CAP	1			
	G60089 -- 5"OD GALV UPR W/O CAP 12	3			
	60088 -- 5"OD ALUM UPR W/CAP 14'	3			
	60944 -- 5"OD ALUM UPR 15'W/O CAP	4			
	71503 -- FLAT CAP PACKAGE	1			
	71861 -- CASCADE TUBE SLIDE	1			
RDU	CUSTOM 2-5 SUPERMAX STRUCTURE	1	2398.74	\$47,772.00	\$47,772.00
	71031 -- RING CLAMP ASSEMBLY	33			
	71649 -- LEFT CURVED SLIDE (4')	1			
	61046 -- TRIANGLE TRANSFER POINT	1			
	71119 -- MAXCLIMB SUMMIT	1			
	71002 -- ISOSCELES DECK	2			
	60062 -- SMALL KICKPLATE	1			
	72080 -- TREES ACTIVITY PANEL	1			
	71990 -- Water Cycle Panel	1			
	71512 -- SQ SLAT ROOF	1			
	71543 -- BEANSTALK CLIMBER 3'-4"	1			
	71551 -- 3'-4"ROPE LADDER	1			
	71758 -- PINNACLE CLIMB W/DBL ENT	1			
	60172 -- LARGE KICKPLATE-16"DECK	1			
	60061 -- SMALL KICKPLATE-8"SPACE	2			
	71000 -- SQUARE DECK	3			
	60059 -- 5"OD ALUM UPR 10'W/CAP	4			
	60060 -- 5"OD ALUM UPR 12'W/CAP	1			
	60040 -- 11'POST W/O CAP ALUM	4			
	71348 -- SEAT FOR TWO AND TABLE	1			
RDU	3.5" ARCH SWINGS	1	1075	\$17,160.00	\$17,160.00
	65179 -- TWEEN MATES SWING 3 1/2"	2			
	67620 -- 3 1/2"OD ADA ARCH SWG AAB	1			
	67734 -- ONE-FOR-ALL SWING SEAT	1			
	67915 -- 3 1/2"MADE-FOR-ME SEAT GV	1			
	68034 -- 3.5"OD STANDARD ARCH SWIN	1			
	68035 -- 3.5"OD STD ARCH SWING AAB	1			
	65167 -- REFLECTIONS SELFIE SWING 3.5"	2			
RDU	FREESTANDING	1	744	\$15,942.00	\$15,942.00
	65290 -- WELCOME SIGN 2 - 5	1			
	7310 -- 20"HYPNETIC WHEEL 2-SIDE	1			
	7352 -- 20" TWO SIDED HOURGLASS	1			
	7360 -- 20" TWO SIDED ROLLER BALLS	1			
	65288 -- WELCOME SIGN 5 - 12	1			
	68115 -- ACTIVITY METER	3			
	SF-126 -- 6' BENCH INGROUND	4			
	313199 -- PPS OWNER'S KIT	1			
	68156 -- SPINNING SEAT	1			
3TST	NatureROCKS TREE STUMPS - SET OF 3 (2-5 yr.)	1	0	\$4,308.00	\$4,308.00
5TSL	NatureROCKS TREE SLICES - SET OF 5	2	0	\$2,246.00	\$4,492.00
EWF	348 CY OF EWF	1	0	\$7,915.00	\$7,915.00
EWF	EWF FREIGHT (BLOWN IN)	1	0	\$26,290.00	\$26,290.00
	MERIDIAN SINGLE SLACK BRIDGE	1	0	\$3,950.00	\$3,950.00
INSTALL	INSTALL- of new structures in large area only. PREVAILING WAGE	1	0	\$146,385.00	\$146,385.00
	DEMO- Estimate is for demo of existing equipment, sand (12" over 7000 sf) in large				

INSTALL	area only. Does not include any fitness equipment or science area demo/install. No base is included as area will get EWF on top of existing sub grade.	1	0	\$50,575.00	\$50,575.00
---------	--	---	---	-------------	-------------

Total Weight: 14201.71

SubTotal: \$527,493.00
Discount: \$120,868.80
Freight: \$21,724.13
Tax: \$15,200.65
Total Amount: \$443,548.98

Pricing per National IPA / OMNIA Partners Public Sector Contract #R220202. _____ Please reference contract number on your purchase order made out to Play and Park Structures. _____
Conditions-Exclusions: Estimate does not include any drainage, concrete work, asphalt cutting or coring, containment or permits, unless detailed in estimate. Access: Site should be clear, level and allow for unrestricted access of trucks and machinery. Staging area for dumpsters and equipment will be required within 100' of playground. Storage: Customer is responsible for providing a secure location to off-load and store the equipment during the installation process. Once equipment has been delivered to the site, the owner is responsible should theft or vandalism occur unless other arrangements have been made and noted on this quote. Footer Excavation: Installation pricing is based on footer excavation through earth/soil only. Customer shall be responsible for unknown conditions such as buried utilities (public or private), tree stumps, rock, or any other concealed materials or conditions that may result in additional labor or materials cost. Utilities: Owner is responsible for locating any utilities.

THIS QUOTATION IS SUBJECT TO POLICIES IN THE CURRENT PLAY & PARK STRUCTURES CATALOG AND THE FOLLOWING TERMS AND CONDITIONS. OUR QUOTATION IS BASED ON SHIPMENT OF ALL ITEMS AT ONE TIME TO A SINGLE DESTINATION, UNLESS NOTED, AND CHANGES ARE SUBJECT TO PRICE ADJUSTMENT. PURCHASES IN EXCESS OF \$1,000.00 TO BE SUPPORTED BY YOUR WRITTEN PURCHASE ORDER MADE OUT TO PLAY & PARK STRUCTURES, C/O Play & Park Structures of Central Coast CA.

Pricing: f.o.b. factory, firm for 30 days from date of quotation.

Freight charges: Prepaid & added

Installation: A certified Play & Park Structures Installer is recommended for play equipment installation. Customer shall be responsible for scheduling coordination and site preparation. Site should be level and permit installation equipment access. Purchaser shall be responsible for unknown conditions such as buried utilities, tree stumps, bedrock or any concealed materials or conditions that may result in additional labor or material costs.

Submittals: our design proposal reflects the spirit and intent of the project plans and specifications. While some variations may exist between our quotation and the project design, the differences do not materially affect the intended use. Play & Park Structures designs and specifications are unique and not intended to be identical in all respects to other manufacturers. We shall submit for review and approval by the owner's representative detailed drawings depicting the equipment to be furnished accompanied by specifications describing materials. Once approved, these drawings and specifications shall constitute the final documents for the project and shall take precedence over all other requirements.

Exclusions: unless specifically included, this quotation excludes all site work and landscaping; removal of existing equipment; acceptance of equipment and off-loading; storage of goods prior to installation; equipment assembly and installation; safety surfacing; borders and drainage provisions.

Acceptance of quotation:

Accepted By (printed): _____

Signature: _____

Title: _____

Purchase Amount: _____ \$443,548.98

P.O. No: _____

Date: _____

Phone: _____

E-mail: _____

Order Information

Bill to: _____

Company: _____

Attn: _____

Address: _____

City/State/Zip: _____

Billing Contact: _____

Billing Phone: _____

Billing Fax: _____

Ship to: _____

Company: _____

Attn: _____

Address: _____

City/State/Zip: _____

Jobsite Contact: _____

Jobsite Phone: _____

Jobsite Fax: _____

Enter desired color palette name: _____ OR _____

Enter desired color: Uprights () Decks ()

Accents () Roofs/Tubes () Slides/Panels ()

Play & Park Structures of Central Coast CA

By: _____

Salesperson's signature

PPS is not responsible for Permits, Fees, Engineering, unidentified utilities. extremely rocky or hard soils, Dewatering, disposal of hazardous materials, landscaping or irrigation. Price does not include unloading and receiving, security, fencing and portable restroom.

Salespersons's Signature

Customer's Signature





6,964 SQ. FT.
333 LINEAR FT.
TOTAL INSIDE AREA

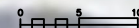

THE SITE DIMENSIONS WERE REFERENCED FROM SATELLITE IMAGING AND MUST BE VERIFIED FOR ACCURACY.

	Total Play Components	37			<table border="1"> <tr> <td colspan="2">User Capacity</td> </tr> <tr> <td colspan="2">140-145</td> </tr> <tr> <td colspan="2">Critical Fall Height</td> </tr> <tr> <td colspan="2">8'-0"</td> </tr> </table>	User Capacity		140-145		Critical Fall Height		8'-0"	
	User Capacity												
	140-145												
	Critical Fall Height												
	8'-0"												
Elevated Play Components	16												
Elevated Play Components Accessible by Ramp	5	Req.	4										
Elevated Components Accessible by Transfer	10	Req.	4										
Accessible Ground Level Components Shown	21	Req.	0										
Different Types of Ground Level Components	5	Req.	0										



UPRIGHT BRONZE ACCENT GREEN DECK BROWN PLASTIC BEIGE/GREEN/BROWN HDPE BROWN HDPE2C BROWN/WHITE SHADE FOREST ROOF RECYCLED CABLE BLACK MAX/APEX GRANITE/SAND

LOKKER PARK
CAMARILLO, CA

821-1643081

PLEASE NOTE: RENDERINGS ARE FOR VISUAL PURPOSES ONLY. ANY PRODUCTS AND/OR SITE DETAILS HEREIN MAYBE SUBJECT TO CHANGE WITHOUT NOTICE.



544 CHESTNUT ST.
 CHATTANOOGA, TN 37402
800.727.1907
PLAYANDPARK.COM

1/8/220



UPRIGHT BRONZE ACCENT GREEN DECK BROWN PLASTIC BEIGE/GREEN/BROWN HDPE BROWN HDPE2C BROWN/WHITE SHADE FOREST ROOF RECYCLED CABLE BLACK MAX/APEX GRANITE/SAND

LOKKER PARK CAMARILLO, CA

821-1643081

PLEASE NOTE: RENDERINGS ARE FOR VISUAL PURPOSES ONLY. ANY PRODUCTS AND/OR SITE DETAILS HEREIN MAYBE SUBJECT TO CHANGE WITHOUT NOTICE.

play&park
structures
A PLAYCORE Company

544 CHESTNUT ST.
CHATTANOOGA, TN 37402
800.727.1907
PLAYANDPARK.COM

11/9/220



UPRIGHT BRONZE ACCENT GREEN DECK BROWN PLASTIC BEIGE/GREEN/BROWN HDPE BROWN HDPE2C BROWN/WHITE SHADE FOREST ROOF RECYCLED CABLE BLACK MAX/APEX GRANITE/SAND

LOKKER PARK

CAMARILLO, CA

821-1643081

PLEASE NOTE: RENDERINGS ARE FOR VISUAL PURPOSES ONLY. ANY PRODUCTS AND/OR SITE DETAILS HEREIN MAYBE SUBJECT TO CHANGE WITHOUT NOTICE.

play&park
structures
A PLAYCORE Company

544 CHESTNUT ST.
 CHATTANOOGA, TN 37402
800.727.1907
PLAYANDPARK.COM

10/220



UPRIGHT BRONZE ACCENT GREEN DECK BROWN PLASTIC BEIGE/GREEN/BROWN HDPE BROWN HDPE2C BROWN/WHITE SHADE FOREST ROOF RECYCLED CABLE BLACK MAX/APEX GRANITE/SAND

LOKKER PARK

CAMARILLO, CA

821-1643081

PLEASE NOTE: RENDERINGS ARE FOR VISUAL PURPOSES ONLY. ANY PRODUCTS AND/OR SITE DETAILS HEREIN MAYBE SUBJECT TO CHANGE WITHOUT NOTICE.

play&park
structures
A PLAYCORE Company

544 CHESTNUT ST.
 CHATTANOOGA, TN 37402
800.727.1907
PLAYANDPARK.COM

10/1/220



UPRIGHT BRONZE

ACCENT GREEN

DECK BROWN

PLASTIC BEIGE/GREEN/BROWN HDPE BROWN

HDPE2C BROWN/WHITE SHADE FOREST

ROOF RECYCLED

CABLE BLACK

MAX/APEX GRANITE/SAND

LOKKER PARK CAMARILLO, CA

821-1643081

PLEASE NOTE: RENDERINGS ARE FOR VISUAL PURPOSES ONLY. ANY PRODUCTS AND/OR SITE DETAILS HEREIN MAYBE SUBJECT TO CHANGE WITHOUT NOTICE.

play&park
structures
A PLAYCORE Company

544 CHESTNUT ST.
CHATTANOOGA, TN 37402

800.727.1907
PLAYANDPARK.COM

6/2/220



Play & Park Structures of Central Coast CA
 2390 C #170 Los Posas Rd.
 Camarillo, CA, 93010
 Phone: 661-964-7626
 Fax:
 Email:
 kathy.wiggins@playandpark.com
 Contact: Kathy Wiggins

Lokker Park

Pleasant Valley Recreation & Park
 Attn: Nick Marienthal
 1605 E. Burnley Street
 Camarillo, CA 93010
 Phone: 805-482-5396
 nmarienthal@pvprpd.org

Quote Number: 821-164308H
 Quote Date: 4/1/2024

Stock ID	Description	Quantity	Weight	Unit Price	Amount
RDU	CUSTOM 5-12 SUPERMAX STRUCTURE	1	9983.97	\$202,704.00	\$202,704.00
	71031 -- RING CLAMP ASSEMBLY	109			
	71532 -- HALF HEX SLAT ROOF W/EXT	2			
	71419 -- SIGN LANGUAGE PANEL	1			
	71348 -- SEAT FOR TWO AND TABLE	1			
	71003 -- SEMI-HEX DECK	4			
	71308 -- CABLE SWAY LINK	1			
	71774 -- ISOSCELES FABRIC SHADE	2			
	72159 -- SUPERMAX 10' x 10' SHADE 1'- 6'	1			
	71370 -- ANGLED ROCK	1			
	60061 -- SMALL KICKPLATE-8"SPACE	2			
	71300 -- VERT ACCESS LADDER 4'-0"	1			
	71385 -- BALCONY DECK	2			
	71344 -- RAIN WHEEL	1			
	71395 -- MINI PANEL	1			
	7202 -- ECHO CHAMBER ASSEMBLY	1			
	71346 -- SINGLE SEAT	1			
	71403 -- SPIN & WIN PANEL	1			
	71013 -- METAL HANDHOLD BARRIER	2			
	71186 -- HORIZ LOOP LADDER-ATTACH	1			
	60645 -- DECK CURB	1			
	71425 -- DRUM LINE	1			
	7357 -- 20" TWO SIDED PACHINKO	1			
	72066 -- INTERACTIVE SENSOR PANEL	1			
	71317 -- SINGLE U-HANDLE	2			
	60172 -- LARGE KICKPLATE-16"DECK	1			
	71680 -- DOUBLE VELOCITY 2'-8"	1			
	71464 -- SLIDE TRANSFER	1			
	71968 -- Shop Panel	1			
	71249 -- BENCH SEAT	1			
	71664 -- 4'-0"ZIP STEP CLIMBER	1			
	71139 -- MESH BARRIER PANEL	1			
	71338 -- HAND PEDALER	1			
	71002 -- ISOSCELES DECK	3			
	71162 -- HORIZ LOOP LADDER-LINK	1			
	71001 -- TRIANGLE DECK	2			
	72127 -- 16" Rise, 4' Span ZEPHYR LINK	1			
	60062 -- SMALL KICKPLATE	1			
	71017 -- RAMP DECK TO DECK	1			
	71015 -- RAMP DECK TO GROUND	1			
	72043 -- SM TRAPEZOID DECK	2			
	71531 -- CLUB HOUSE CLIMBER	1			
	72021 -- SUMMIT CLIMBER 8' - 0"	1			
	71645 -- SPY BARRIER	1			
	71903 -- LONG EXIT SECTION	1			
	71675 -- CURVE LEFT SECTION	1			
	71715 -- 2'STRAIGHT SECTION	1			

	71678 -- SLIDE SUPPORT	1			
	71897 -- DUELLING CRISS-CROSS CASCADE	1			
	71475 -- DECK TO DECK STAIR 4'-0"	1			
	60059 -- 5"OD ALUM UPR 10'W/CAP	6			
	60949 -- 5"OD ALUM UPR 7' W/CAP	5			
	60178 -- 5"OD ALUM UPR 8' W/CAP	1			
	60948 -- 5"OD ALUM UPR 11' W/CAP	2			
	61540 -- 5"OD ALUM UPR 4'W/O CAP	1			
	60041 -- 13'POST W/O CAP ALUM	4			
	G60944 -- 5"OD GALV UPR 15'W/O CAP	3			
	G60042 -- 5"OD UPR GALV 168"W/O CAP	1			
	G60089 -- 5"OD GALV UPR W/O CAP 12	3			
	60088 -- 5"OD ALUM UPR W/CAP 14'	3			
	60944 -- 5"OD ALUM UPR 15'W/O CAP	4			
	71503 -- FLAT CAP PACKAGE	1			
	71861 -- CASCADE TUBE SLIDE	1			
RDU	CUSTOM 2-5 SUPERMAX STRUCTURE	1	2398.74	\$47,772.00	\$47,772.00
	71031 -- RING CLAMP ASSEMBLY	33			
	71649 -- LEFT CURVED SLIDE (4')	1			
	61046 -- TRIANGLE TRANSFER POINT	1			
	71119 -- MAXCLIMB SUMMIT	1			
	71002 -- ISOSCELES DECK	2			
	60062 -- SMALL KICKPLATE	1			
	72080 -- TREES ACTIVITY PANEL	1			
	71990 -- Water Cycle Panel	1			
	71512 -- SQ SLAT ROOF	1			
	71543 -- BEANSTALK CLIMBER 3'-4"	1			
	71551 -- 3'-4"ROPE LADDER	1			
	71758 -- PINNACLE CLIMB W/DBL ENT	1			
	60172 -- LARGE KICKPLATE-16"DECK	1			
	60061 -- SMALL KICKPLATE-8"SPACE	2			
	71000 -- SQUARE DECK	3			
	60059 -- 5"OD ALUM UPR 10'W/CAP	4			
	60060 -- 5"OD ALUM UPR 12'W/CAP	1			
	60040 -- 11'POST W/O CAP ALUM	4			
	71348 -- SEAT FOR TWO AND TABLE	1			
RDU	3.5" ARCH SWINGS	1	1075	\$17,160.00	\$17,160.00
	65179 -- TWEEN MATES SWING 3 1/2"	2			
	67620 -- 3 1/2"OD ADA ARCH SWG AAB	1			
	67734 -- ONE-FOR-ALL SWING SEAT	1			
	67915 -- 3 1/2"MADE-FOR-ME SEAT GV	1			
	68034 -- 3.5"OD STANDARD ARCH SWIN	1			
	68035 -- 3.5"OD STD ARCH SWING AAB	1			
	65167 -- REFLECTIONS SELFIE SWING 3.5"	2			
RDU	FITNESS AREA	1	895	\$25,235.00	\$25,235.00
	UP168S -- SIT-UP/BACK EXT(IN-GRD)	1			
	UP179S -- CHEST PRESS ACCESS-IN-GRD	1			
	UP177 -- BALANCE BOARD	1			
	up226s -- CHIN UP HI/LOW COMBO (INGRD)	1			
	up215s -- RECUMBENT CYCLE (INGRD)	1			
313199	PPS OWNER'S KIT	1	11	\$0.00	\$0.00
3TST	NatureROCKS TREE STUMPS - SET OF 3 (2-5 yr.)	1	0	\$4,308.00	\$4,308.00
5TSL	NatureROCKS TREE SLICES - SET OF 5	2	0	\$2,246.00	\$4,492.00
EWF	434 CY OF EWF	1	0	\$9,550.00	\$9,550.00
	- Fitness Area: 290 SF Science Area: 1,417 SF Playground Area: 6,969 SF @ 12"				
EWF	EWF FREIGHT (BLOWN IN)	1	0	\$33,020.00	\$33,020.00
YP343	MERIDIAN SINGLE SLACK BRIDGE	1	0	\$3,950.00	\$3,950.00
RDU	FREESTANDING	1	942	\$18,228.00	\$18,228.00
	65290 -- WELCOME SIGN 2 - 5	1			
	7310 -- 20"HYPNETIC WHEEL 2-SIDE	1			
	7352 -- 20" TWO SIDED HOURGLASS	1			
	7360 -- 20" TWO SIDED ROLLER BALLS	1			
	65288 -- WELCOME SIGN 5 - 12	1			

68115 -- ACTIVITY METER	3
SF-126 -- 6' BENCH INGROUND	5
68156 -- SPINNING SEAT	1
67643 -- CURVED BALANCE BEAM F/S	1

INSTALL	INSTALL- of new structures, fitness equipment and science area. PREVAILING WAGE	1	0	\$201,500.00	\$201,500.00
---------	---	---	---	--------------	--------------

INSTALL	DEMO- : Estimate is for demo of existing equipment, sand (12" over 8417 sf). No base is included as area will get EWF on top of existing sub grade.	1	0	\$62,050.00	\$62,050.00
---------	---	---	---	-------------	-------------

Total Weight: 15305.71

SubTotal: \$629,969.00

Discount: \$122,409.45

Freight: \$23,243.01

Tax: \$15,296.74

Total Amount: \$546,099.30

Pricing per National IPA / OMNIA Partners Public Sector Contract #R220202. _____ Please reference contract number on your purchase order made out to Play and Park Structures. _____

Conditions-Exclusions: Estimate does not include any drainage, concrete work, asphalt cutting or coring, containment or permits, unless detailed in estimate. Access: Site should be clear, level and allow for unrestricted access of trucks and machinery. Staging area for dumpsters and equipment will be required within 100' of playground. Storage: Customer is responsible for providing a secure location to off-load and store the equipment during the installation process. Once equipment has been delivered to the site, the owner is responsible should theft or vandalism occur unless other arrangements have been made and noted on this quote. Footer Excavation: Installation pricing is based on footer excavation through earth/soil only. Customer shall be responsible for unknown conditions such as buried utilities (public or private), tree stumps, rock, or any other concealed materials or conditions that may result in additional labor or materials cost. Utilities: Owner is responsible for locating any utilities.

THIS QUOTATION IS SUBJECT TO POLICIES IN THE CURRENT PLAY & PARK STRUCTURES CATALOG AND THE FOLLOWING TERMS AND CONDITIONS. OUR QUOTATION IS BASED ON SHIPMENT OF ALL ITEMS AT ONE TIME TO A SINGLE DESTINATION, UNLESS NOTED, AND CHANGES ARE SUBJECT TO PRICE ADJUSTMENT. PURCHASES IN EXCESS OF \$1,000.00 TO BE SUPPORTED BY YOUR WRITTEN PURCHASE ORDER MADE OUT TO PLAY & PARK STRUCTURES, C/O Play & Park Structures of Central Coast CA.

Pricing: f.o.b. factory, firm for 30 days from date of quotation.

Freight charges: Prepaid & added

Installation: A certified Play & Park Structures Installer is recommended for play equipment installation. Customer shall be responsible for scheduling coordination and site preparation. Site should be level and permit installation equipment access. Purchaser shall be responsible for unknown conditions such as buried utilities, tree stumps, bedrock or any concealed materials or conditions that may result in additional labor or material costs.

Submittals: our design proposal reflects the spirit and intent of the project plans and specifications. While some variations may exist between our quotation and the project design, the differences do not materially affect the intended use. Play & Park Structures designs and specifications are unique and not intended to be identical in all respects to other manufacturers. We shall submit for review and approval by the owner's representative detailed drawings depicting the equipment to be furnished accompanied by specifications describing materials. Once approved, these drawings and specifications shall constitute the final documents for the project and shall take precedence over all other requirements.

Exclusions: unless specifically included, this quotation excludes all site work and landscaping; removal of existing equipment; acceptance of equipment and off-loading; storage of goods prior to installation; equipment assembly and installation; safety surfacing; borders and drainage provisions.

Acceptance of quotation:

Accepted By (printed): _____

Signature: _____

Title: _____

Purchase Amount: _____ \$546,099.30

P.O. No: _____

Date: _____

Phone: _____

E-mail: _____

Order Information

Bill to:

Company: _____

Attn: _____

Address: _____

City/State/Zip: _____

Billing Contact: _____

Billing Phone: _____

Billing Fax: _____

Ship to:

Company: _____

Attn: _____

Address: _____

City/State/Zip: _____

Jobsite Contact: _____

Jobsite Phone: _____

Jobsite Fax: _____

Enter desired color palette name: _____ OR

Enter desired color: Uprights () Decks ()

Accents () Roofs/Tubes () Slides/Panels ()

Play & Park Structures of Central Coast CA

By: _____

Salesperson's signature

PPS is not responsible for Permits, Fees, Engineering, unidentified utilities. extremely rocky or hard soils, Dewatering, disposal of hazardous materials, landscaping or irrigation. Price does not include unloading and receiving, security, fencing and portable restroom.

Salespersons's Signature

Customer's Signature



This play equipment is recommended for children ages:
2-5 & 5-12

Minimum Area Required:
Per Site

Scale: 1/8" = 1'-0"
This drawing can be scaled only when in a 24" x 36" format

Drawn By:
Cassie Pruitt
Date:
3/14/24
Quote Number:
821-164308H



A PLAYCORE Company
544 Chestnut Street
Chattanooga, TN 37402
800-727-1907 / www.playandpark.com

User Capacity
200+
Critical Fall Height
8'-0"



6,964 SQ. FT.
333 LINEAR FT.
TOTAL INSIDE AREA

1,417 SQ. FT.
154 LINEAR FT.
TOTAL INSIDE AREA

0 5 10
THE SITE DIMENSIONS WERE REFERENCED FROM SATELLITE IMAGING AND MUST BE VERIFIED FOR ACCURACY.

	Total Play Components	38			<table border="1"> <tr> <td colspan="2">User Capacity</td> </tr> <tr> <td colspan="2">140-145</td> </tr> <tr> <td colspan="2">Critical Fall Height</td> </tr> <tr> <td colspan="2">8'-0"</td> </tr> </table>	User Capacity		140-145		Critical Fall Height		8'-0"	
	User Capacity												
	140-145												
	Critical Fall Height												
	8'-0"												
Elevated Play Components	16												
Elevated Play Components Accessible by Ramp	5	Req.	4										
Elevated Components Accessible by Transfer	10	Req.	4										
Accessible Ground Level Components Shown	22	Req.	0										
Different Types of Ground Level Components	5	Req.	0										



UPRIGHT BRONZE

ACCENT GREEN

DECK BROWN

PLASTIC BEIGE/GREEN/BROWN HDPE BROWN

HDPE2C BROWN/WHITE SHADE FOREST

ROOF RECYCLED

CABLE BLACK

MAX/APEX GRANITE/SAND

LOKKER PARK
CAMARILLO, CA

821-164308H

PLEASE NOTE: RENDERINGS ARE FOR VISUAL PURPOSES ONLY. ANY PRODUCTS AND/OR SITE DETAILS HEREIN MAYBE SUBJECT TO CHANGE WITHOUT NOTICE.



544 CHESTNUT ST.
 CHATTANOOGA, TN 37402

800.727.1907
PLAYANDPARK.COM

10/8/220



UPRIGHT BRONZE ACCENT GREEN DECK BROWN PLASTIC BEIGE/GREEN/BROWN HDPE BROWN HDPE2C BROWN/WHITE SHADE FOREST ROOF RECYCLED CABLE BLACK MAX/APEX GRANITE/SAND

LOKKER PARK CAMARILLO, CA

821-164308H

PLEASE NOTE: RENDERINGS ARE FOR VISUAL PURPOSES ONLY. ANY PRODUCTS AND/OR SITE DETAILS HEREIN MAYBE SUBJECT TO CHANGE WITHOUT NOTICE.

play&park
structures
A PLAYCORE Company

544 CHESTNUT ST.
CHATTANOOGA, TN 37402
800.727.1907
PLAYANDPARK.COM

6/9/220



UPRIGHT BRONZE

ACCENT GREEN

DECK BROWN

PLASTIC BEIGE/GREEN/BROWN HDPE BROWN

HDPE2C BROWN/WHITE SHADE FOREST

ROOF RECYCLED

CABLE BLACK

MAX/APEX GRANITE/SAND

LOKKER PARK CAMARILLO, CA

821-164308H

PLEASE NOTE: RENDERINGS ARE FOR VISUAL PURPOSES ONLY. ANY PRODUCTS AND/OR SITE DETAILS HEREIN MAYBE SUBJECT TO CHANGE WITHOUT NOTICE.

play&park
structures
A PLAYCORE Company

544 CHESTNUT ST.
CHATTANOOGA, TN 37402

800.727.1907
PLAYANDPARK.COM

10/0/220



UPRIGHT BRONZE

ACCENT GREEN

DECK BROWN

PLASTIC BEIGE/GREEN/BROWN HDPE BROWN

HDPE2C BROWN/WHITE SHADE FOREST

ROOF RECYCLED

CABLE BLACK

MAX/APEX GRANITE/SAND

LOKKER PARK CAMARILLO, CA

821-164308H

PLEASE NOTE: RENDERINGS ARE FOR VISUAL PURPOSES ONLY. ANY PRODUCTS AND/OR SITE DETAILS HEREIN MAYBE SUBJECT TO CHANGE WITHOUT NOTICE.

play&park
structures
A PLAYCORE Company

544 CHESTNUT ST.
CHATTANOOGA, TN 37402

800.727.1907
PLAYANDPARK.COM

01/220

Lokker Park
Camarillo, CA

Play & Park Structures

This play equipment is recommended for children ages:
2-5 & 5-12
Minimum Area Required:
Per Site

Scale: 3/16" = 1'-0"
This drawing can be scaled only when in an 24" x 36" format

Drawn By:
Cassie Pruitt
Date:
3/14/24
Quote Number:
821-164308H

play&park
structures
A PLAYCORE Company
544 Chestnut Street
Chattanooga, TN 37402
800-727-1907 / www.playandpark.com

User Capacity
200+
Critical Fall Height
8'-0"

ISO
9001
CERTIFIED

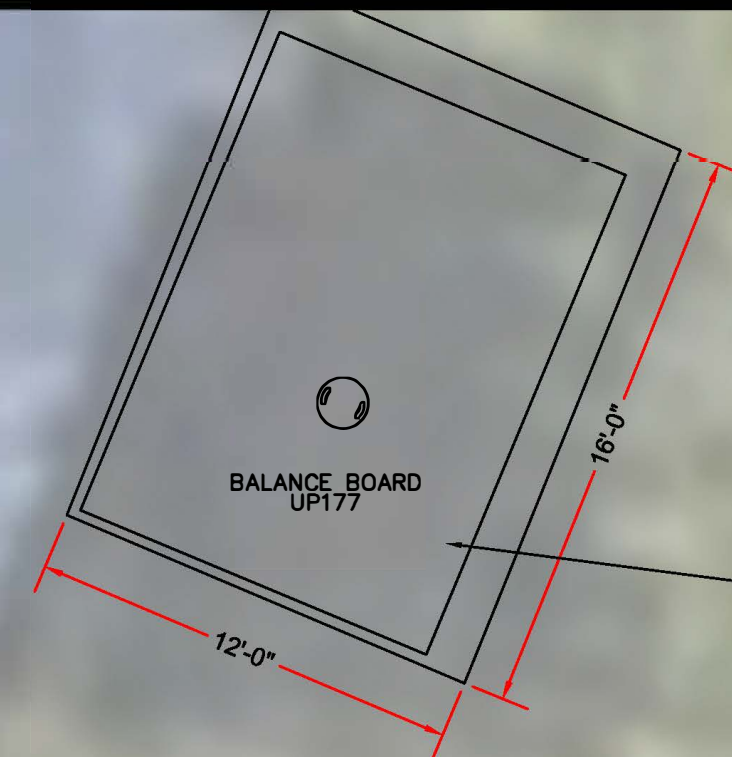

193 SQ. FT.
57 LINEAR FT.
TOTAL INSIDE AREA

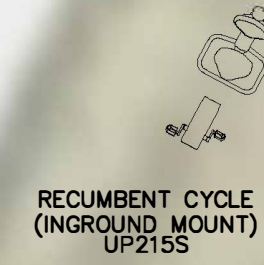

THE SITE DIMENSIONS WERE REFERENCED FROM SATELLITE IMAGING AND MUST BE VERIFIED FOR ACCURACY.

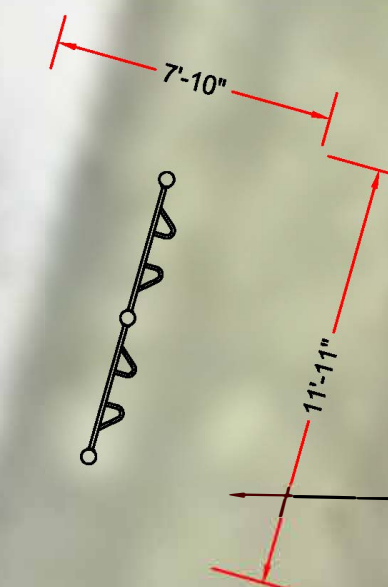

97 SQ. FT.
41 LINEAR FT.
TOTAL INSIDE AREA

CHIN-UP HIGH/LOW COMBO
IN-GROUND (ADVANCED SERIES)
UP226S



THE SITE DIMENSIONS WERE REFERENCED FROM SATELLITE IMAGING AND MUST BE VERIFIED FOR ACCURACY.

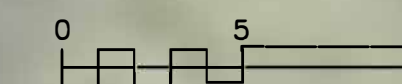
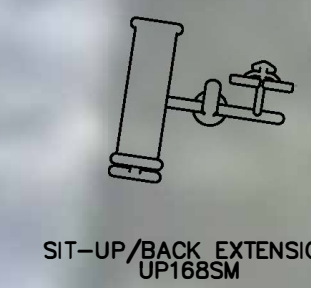

THE SITE DIMENSIONS WERE REFERENCED FROM SATELLITE IMAGING AND MUST BE VERIFIED FOR ACCURACY.

IMPORTANT: Never install play equipment over hard, unresilient surfaces such as asphalt, concrete, or compacted earth. It is the owner's responsibility to ensure the "minimum area required" contains an appropriate amount of resilient material to cushion accidental falls.



Play & Park Structures of Central Coast CA
 2390 C #170 Los Posas Rd.
 Camarillo, CA, 93010
 Phone: 661-964-7626
 Fax:
 Email:
 kathy.wiggins@playandpark.com
 Contact: Kathy Wiggins

Lokker Park

Pleasant Valley Recreation & Park
 Attn: Nick Marienthal
 1605 E. Burnley Street
 Camarillo, CA 93010
 Phone: 805-482-5396
 nmarienthal@pvrpd.org

Quote Number: 821-164308G
 Quote Date: 4/1/2024

Stock ID	Description	Quantity	Weight	Unit Price	Amount
RDU	CUSTOM 5-12 SUPERMAX STRUCTURE	1	14189.73	\$226,372.00	\$226,372.00
	71031 -- RING CLAMP ASSEMBLY	101			
	71774 -- ISOSCELES FABRIC SHADE	2			
	72159 -- SUPERMAX 10' x 10' SHADE 1'- 6'	1			
	71370 -- ANGLED ROCK	1			
	71532 -- HALF HEX SLAT ROOF W/EXT	1			
	60061 -- SMALL KICKPLATE-8"SPACE	2			
	71300 -- VERT ACCESS LADDER 4'-0"	1			
	71385 -- BALCONY DECK	2			
	71344 -- RAIN WHEEL	1			
	71395 -- MINI PANEL	1			
	7202 -- ECHO CHAMBER ASSEMBLY	1			
	71346 -- SINGLE SEAT	1			
	71403 -- SPIN & WIN PANEL	1			
	71013 -- METAL HANDHOLD BARRIER	2			
	71186 -- HORIZ LOOP LADDER-ATTACH	1			
	60645 -- DECK CURB	1			
	71425 -- DRUM LINE	1			
	7357 -- 20" TWO SIDED PACHINKO	1			
	72066 -- INTERACTIVE SENSOR PANEL	1			
	71317 -- SINGLE U-HANDLE	2			
	60172 -- LARGE KICKPLATE-16"DECK	1			
	71680 -- DOUBLE VELOCITY 2'-8"	1			
	71464 -- SLIDE TRANSFER	1			
	71968 -- Shop Panel	1			
	71249 -- BENCH SEAT	1			
	71664 -- 4'-0"ZIP STEP CLIMBER	1			
	71139 -- MESH BARRIER PANEL	1			
	71338 -- HAND PEDALER	1			
	71002 -- ISOSCELES DECK	3			
	71162 -- HORIZ LOOP LADDER-LINK	1			
	71001 -- TRIANGLE DECK	2			
	72127 -- 16" Rise, 4' Span ZEPHYR LINK	1			
	60062 -- SMALL KICKPLATE	1			
	71003 -- SEMI-HEX DECK	2			
	71017 -- RAMP DECK TO DECK	1			
	71015 -- RAMP DECK TO GROUND	1			
	72043 -- SM TRAPEZOID DECK	2			
	71531 -- CLUB HOUSE CLIMBER	1			
	72021 -- SUMMIT CLIMBER 8' - 0"	1			
	71645 -- SPY BARRIER	1			
	71903 -- LONG EXIT SECTION	1			
	71675 -- CURVE LEFT SECTION	1			
	71715 -- 2'STRAIGHT SECTION	1			
	71678 -- SLIDE SUPPORT	1			
	71897 -- DUELLING CRISS-CROSS CASCADE	1			
	71928 -- GFRC TREE W/DECK & ROOF	1			

	71475 -- DECK TO DECK STAIR 4'-0"	1			
	60059 -- 5"OD ALUM UPR 10'W/CAP	6			
	60949 -- 5"OD ALUM UPR 7' W/CAP	5			
	60178 -- 5"OD ALUM UPR 8' W/CAP	1			
	60948 -- 5"OD ALUM UPR 11' W/CAP	2			
	61540 -- 5"OD ALUM UPR 4'W/O CAP	1			
	60041 -- 13'POST W/O CAP ALUM	4			
	G60944 -- 5"OD GALV UPR 15'W/O CAP	3			
	G60042 -- 5"OD UPR GALV 168"W/O CAP	1			
	G60089 -- 5"OD GALV UPR W/O CAP 12	3			
	71503 -- FLAT CAP PACKAGE	1			
	71308 -- CABLE SWAY LINK	1			
	71861 -- CASCADE TUBE SLIDE	1			
RDU	CUSTOM 2-5 SUPERMAX STRUCTURE	1	2398.74	\$47,772.00	\$47,772.00
	71031 -- RING CLAMP ASSEMBLY	33			
	71649 -- LEFT CURVED SLIDE (4')	1			
	61046 -- TRIANGLE TRANSFER POINT	1			
	71119 -- MAXCLIMB SUMMIT	1			
	71002 -- ISOSCELES DECK	2			
	60062 -- SMALL KICKPLATE	1			
	72080 -- TREES ACTIVITY PANEL	1			
	71990 -- Water Cycle Panel	1			
	71512 -- SQ SLAT ROOF	1			
	71543 -- BEANSTALK CLIMBER 3'-4"	1			
	71551 -- 3'-4"ROPE LADDER	1			
	71758 -- PINNACLE CLIMB W/DBL ENT	1			
	60172 -- LARGE KICKPLATE-16"DECK	1			
	60061 -- SMALL KICKPLATE-8"SPACE	2			
	71000 -- SQUARE DECK	3			
	60059 -- 5"OD ALUM UPR 10'W/CAP	4			
	60060 -- 5"OD ALUM UPR 12'W/CAP	1			
	60040 -- 11'POST W/O CAP ALUM	4			
	71348 -- SEAT FOR TWO AND TABLE	1			
RDU	3.5" ARCH SWINGS	1	1075	\$17,160.00	\$17,160.00
	65179 -- TWEEN MATES SWING 3 1/2"	2			
	67620 -- 3 1/2"OD ADA ARCH SWG AAB	1			
	67734 -- ONE-FOR-ALL SWING SEAT	1			
	67915 -- 3 1/2"MADE-FOR-ME SEAT GV	1			
	68034 -- 3.5"OD STANDARD ARCH SWIN	1			
	68035 -- 3.5"OD STD ARCH SWING AAB	1			
	65167 -- REFLECTIONS SELFIE SWING 3.5"	2			
RDU	FREESTANDING	1	1123	\$22,799.00	\$22,799.00
	65290 -- WELCOME SIGN 2 - 5	1			
	7310 -- 20"HYPNETIC WHEEL 2-SIDE	1			
	7352 -- 20" TWO SIDED HOURGLASS	1			
	7360 -- 20" TWO SIDED ROLLER BALLS	1			
	65130 -- LEAF HOP	1			
	65288 -- WELCOME SIGN 5 - 12	1			
	68115 -- ACTIVITY METER	3			
	SF-126 -- 6' BENCH INGROUND	5			
	68156 -- SPINNING SEAT	1			
	67643 -- CURVED BALANCE BEAM F/S	1			
RDU	FITNESS AREA	1	895	\$25,235.00	\$25,235.00
	UP168S -- SIT-UP/BACK EXT(IN-GRD)	1			
	UP179S -- CHEST PRESS ACCESS-IN-GRD	1			
	UP177 -- BALANCE BOARD	1			
	up226s -- CHIN UP HI/LOW COMBO (INGRD)	1			
	up215s -- RECUMBENT CYCLE (INGRD)	1			
313199	PPS OWNER'S KIT	1	11	\$0.00	\$0.00
3TST	NatureROCKS TREE STUMPS - SET OF 3 (2-5 yr.)	1	0	\$4,308.00	\$4,308.00
3SB	NatureROCKS STEPPING BOULDERS - SET OF 3 (2-5 yr)	1	0	\$3,372.00	\$3,372.00
6LT	NatureROCKS 6' LOG TUNNEL	1	0	\$8,622.00	\$8,622.00

5TSL	NatureROCKS TREE SLICES - SET OF 5	3	0	\$2,246.00	\$6,738.00
8FT	NatureROCKS 8' FALLEN TREE BALANCE BEAM	1	0	\$6,560.00	\$6,560.00
EWF	434 CY OF EWF - Fitness Area: 290 SF Science Area: 1,417 SF Playground Area: 6,969 SF @ 12"	1	0	\$9,550.00	\$9,550.00
EWF	EWF FREIGHT (BLOWN IN)	1	0	\$33,020.00	\$33,020.00
INSTALL	INSTALL- of new structures, fitness equipment and science area. PREVAILING WAGE	1	0	\$201,500.00	\$201,500.00
INSTALL	DEMO - Estimate is for demo of existing equipment, sand (12" over 8417 sf) No base is included as area will get EWF on top of existing sub grade	1	0	\$62,050.00	\$62,050.00

Total Weight: 19692.47

SubTotal: \$675,058.00

Discount: \$135,959.50

Freight: \$29,326.12

Tax: \$17,583.32

Total Amount: \$586,007.94

Pricing per National IPA / OMNIA Partners Public Sector Contract #R220202. _____ Please reference contract number on your purchase order made out to Play and Park Structures. _____

Conditions-Exclusions: Estimate does not include any drainage, concrete work, asphalt cutting or coring, containment or permits, unless detailed in estimate. Access: Site should be clear, level and allow for unrestricted access of trucks and machinery. Staging area for dumpsters and equipment will be required within 100' of playground. Storage: Customer is responsible for providing a secure location to off-load and store the equipment during the installation process. Once equipment has been delivered to the site, the owner is responsible should theft or vandalism occur unless other arrangements have been made and noted on this quote. Footer Excavation: Installation pricing is based on footer excavation through earth/soil only. Customer shall be responsible for unknown conditions such as buried utilities (public or private), tree stumps, rock, or any other concealed materials or conditions that may result in additional labor or materials cost. Utilities: Owner is responsible for locating any utilities.

THIS QUOTATION IS SUBJECT TO POLICIES IN THE CURRENT PLAY & PARK STRUCTURES CATALOG AND THE FOLLOWING TERMS AND CONDITIONS. OUR QUOTATION IS BASED ON SHIPMENT OF ALL ITEMS AT ONE TIME TO A SINGLE DESTINATION, UNLESS NOTED, AND CHANGES ARE SUBJECT TO PRICE ADJUSTMENT. PURCHASES IN EXCESS OF \$1,000.00 TO BE SUPPORTED BY YOUR WRITTEN PURCHASE ORDER MADE OUT TO PLAY & PARK STRUCTURES, C/O Play & Park Structures of Central Coast CA.

Pricing: f.o.b. factory, firm for 30 days from date of quotation.

Freight charges: Prepaid & added

Installation: A certified Play & Park Structures Installer is recommended for play equipment installation. Customer shall be responsible for scheduling coordination and site preparation. Site should be level and permit installation equipment access. Purchaser shall be responsible for unknown conditions such as buried utilities, tree stumps, bedrock or any concealed materials or conditions that may result in additional labor or material costs.

Submittals: our design proposal reflects the spirit and intent of the project plans and specifications. While some variations may exist between our quotation and the project design, the differences do not materially affect the intended use. Play & Park Structures designs and specifications are unique and not intended to be identical in all respects to other manufacturers. We shall submit for review and approval by the owner's representative detailed drawings depicting the equipment to be furnished accompanied by specifications describing materials. Once approved, these drawings and specifications shall constitute the final documents for the project and shall take precedence over all other requirements.

Exclusions: unless specifically included, this quotation excludes all site work and landscaping; removal of existing equipment; acceptance of equipment and off-loading; storage of goods prior to installation; equipment assembly and installation; safety surfacing; borders and drainage provisions.

Acceptance of quotation:

Accepted By (printed): _____

Signature: _____

Title: _____

Purchase Amount: _____ \$586,007.94

P.O. No: _____

Date: _____

Phone: _____

E-mail: _____

Order Information

Bill to:

Company: _____

Attn: _____

Address: _____

City/State/Zip: _____

Billing Contact: _____

Billing Phone: _____

Billing Fax: _____

Ship to:

Company: _____

Attn: _____

Address: _____

City/State/Zip: _____

Jobsite Contact: _____

Jobsite Phone: _____

Jobsite Fax: _____

Enter desired color palette name: _____ OR

Enter desired color: Uprights () Decks ()

Accents () Roofs/Tubes () Slides/Panels ()

Play & Park Structures of Central Coast CA

By: _____

Salesperson's signature

PPS is not responsible for Permits, Fees, Engineering, unidentified utilities. extremely rocky or hard soils, Dewatering, disposal of hazardous materials, landscaping or irrigation. Price does not include unloading and receiving, security, fencing and portable restroom.

Salespersons's Signature

Customer's Signature



This play equipment is recommended for children ages:
2-5 & 5-12

Scale: 1/8" = 1'-0"
This drawing can be scaled only when in a 24" x 36" format

Drawn By:
Cassie Pruitt
Date:
3/14/24
Quote Number:
821-164308G



A PLAYCORE Company
544 Chestnut Street
Chattanooga, TN 37402
800-727-1907 / www.playandpark.com

User Capacity
200+
Critical Fall Height
8'-0"



Play & Park Structures



	Total Play Components	38			<table border="1"> <tr> <td colspan="2">User Capacity</td> </tr> <tr> <td colspan="2">140-145</td> </tr> <tr> <td colspan="2">Critical Fall Height</td> </tr> <tr> <td colspan="2">8'-0"</td> </tr> </table>	User Capacity		140-145		Critical Fall Height		8'-0"	
	User Capacity												
	140-145												
	Critical Fall Height												
	8'-0"												
Elevated Play Components	16												
Elevated Play Components Accessible by Ramp	5	Req.	4										
Elevated Components Accessible by Transfer	10	Req.	4										
Accessible Ground Level Components Shown	22	Req.	0										
Different Types of Ground Level Components	5	Req.	0										



UPRIGHT BRONZE

ACCENT GREEN

DECK BROWN

PLASTIC BEIGE/GREEN/BROWN HDPE BROWN

HDPE2C BROWN/WHITE SHADE FOREST

ROOF RECYCLED

CABLE BLACK

MAX/APEX GRANITE/SAND

LOKKER PARK CAMARILLO, CA

821-164308C

PLEASE NOTE: RENDERINGS ARE FOR VISUAL PURPOSES ONLY. ANY PRODUCTS AND/OR SITE DETAILS HEREIN MAYBE SUBJECT TO CHANGE WITHOUT NOTICE.

play&park
structures
A PLAYCORE Company

544 CHESTNUT ST.
CHATTANOOGA, TN 37402

800.727.1907
PLAYANDPARK.COM

10/8/220



UPRIGHT BRONZE ACCENT GREEN DECK BROWN PLASTIC BEIGE/GREEN/BROWN HDPE BROWN HDPE2C BROWN/WHITE SHADE FOREST ROOF RECYCLED CABLE BLACK MAX/APEX GRANITE/SAND

LOKKER PARK
CAMARILLO, CA

821-164308C

PLEASE NOTE: RENDERINGS ARE FOR VISUAL PURPOSES ONLY. ANY PRODUCTS AND/OR SITE DETAILS HEREIN MAYBE SUBJECT TO CHANGE WITHOUT NOTICE.



544 CHESTNUT ST.
 CHATTANOOGA, TN 37402
800.727.1907
PLAYANDPARK.COM

10/9/220



UPRIGHT BRONZE ACCENT GREEN DECK BROWN PLASTIC BEIGE/GREEN/BROWN HDPE BROWN HDPE2C BROWN/WHITE SHADE FOREST ROOF RECYCLED CABLE BLACK MAX/APEX GRANITE/SAND

LOKKER PARK
CAMARILLO, CA

821-164308C

PLEASE NOTE: RENDERINGS ARE FOR VISUAL PURPOSES ONLY. ANY PRODUCTS AND/OR SITE DETAILS HEREIN MAYBE SUBJECT TO CHANGE WITHOUT NOTICE.

play&park
structures
A PLAYCORE Company

544 CHESTNUT ST.
 CHATTANOOGA, TN 37402
800.727.1907
PLAYANDPARK.COM

00/220



UPRIGHT BRONZE ACCENT GREEN DECK BROWN PLASTIC BEIGE/GREEN/BROWN HDPE BROWN HDPE2C BROWN/WHITE SHADE FOREST ROOF RECYCLED CABLE BLACK MAX/APEX GRANITE/SAND

LOKKER PARK CAMARILLO, CA

821-164308C

PLEASE NOTE: RENDERINGS ARE FOR VISUAL PURPOSES ONLY. ANY PRODUCTS AND/OR SITE DETAILS HEREIN MAYBE SUBJECT TO CHANGE WITHOUT NOTICE.

play&park
structures
A PLAYCORE Company

544 CHESTNUT ST.
CHATTANOOGA, TN 37402
800.727.1907
PLAYANDPARK.COM

01/220



UPRIGHT BRONZE

ACCENT GREEN

DECK BROWN

PLASTIC BEIGE/GREEN/BROWN HDPE BROWN

HDPE2C BROWN/WHITE SHADE FOREST

ROOF RECYCLED

CABLE BLACK

MAX/APEX GRANITE/SAND

LOKKER PARK CAMARILLO, CA

821-164308C

PLEASE NOTE: RENDERINGS ARE FOR VISUAL PURPOSES ONLY. ANY PRODUCTS AND/OR SITE DETAILS HEREIN MAYBE SUBJECT TO CHANGE WITHOUT NOTICE.

play&park
structures
A PLAYCORE Company

544 CHESTNUT ST.
CHATTANOOGA, TN 37402

800.727.1907
PLAYANDPARK.COM

02/220

Lokker Park
Camarillo, CA

Play & Park Structures

This play equipment is recommended for children ages:
2-5 & 5-12
Minimum Area Required:
Per Site

Scale: 3/16" = 1'-0"
This drawing can be scaled only when in an 24" x 36" format

Drawn By:
Cassie Pruitt
Date:
3/14/24
Quote Number:
821-164308G

play&park
structures[®]

A PLAYCORE Company
544 Chestnut Street
Chattanooga, TN 37402
800-727-1907 / www.playandpark.com

User Capacity
200+
Critical Fall Height
8'-0"

ISO
9001
CERTIFIED

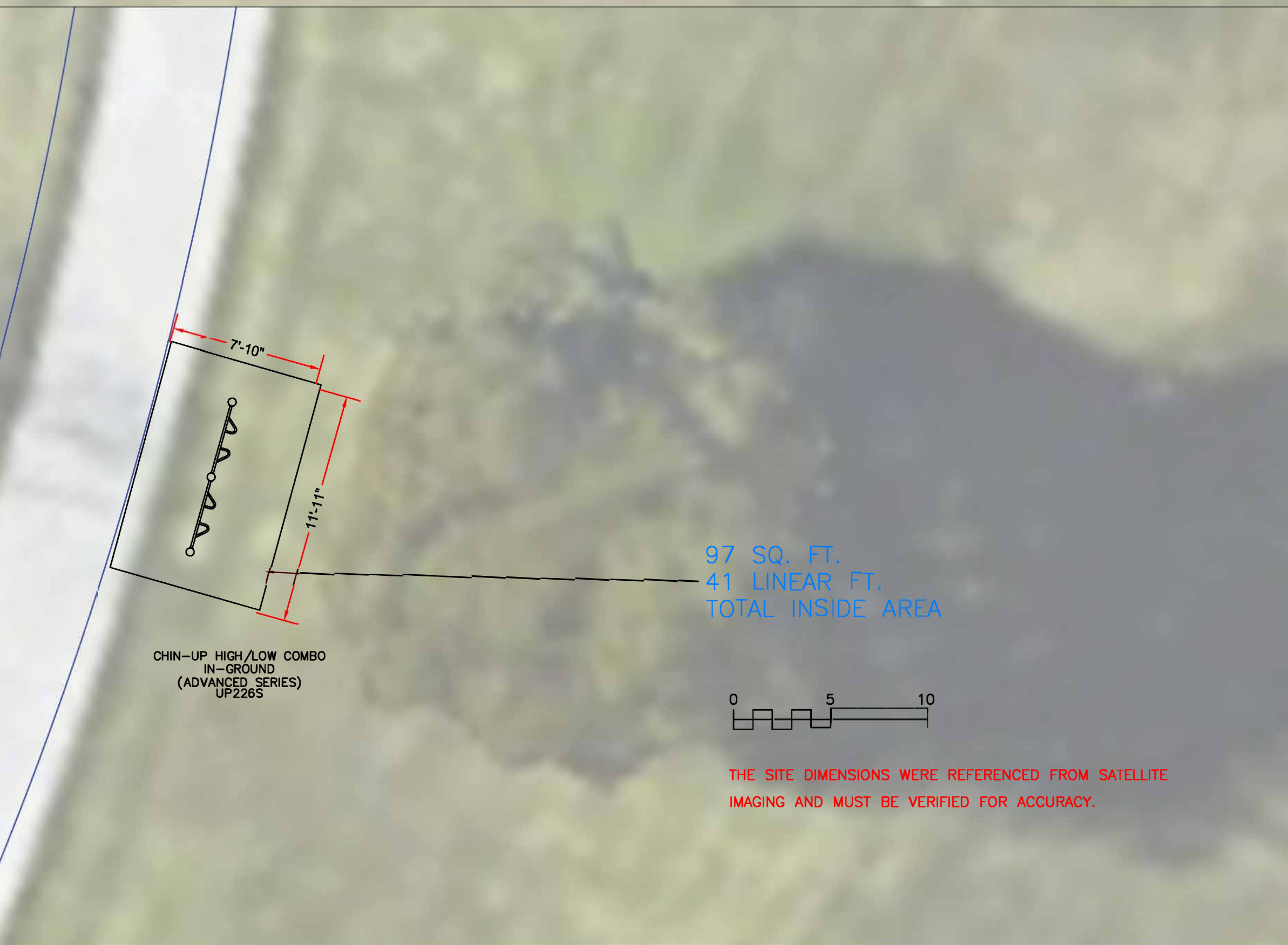

IMPORTANT: Never install play equipment over hard, unresilient surfaces such as asphalt, concrete, or compacted earth. It is the owner's responsibility to ensure the "minimum area required" contains an appropriate amount of resilient material to cushion accidental falls.

**PLEASANT VALLEY RECREATION AND PARK DISTRICT
STAFF REPORT / AGENDA REPORT**

TO: BOARD OF DIRECTORS

FROM: MARY OTTEN, GENERAL MANAGER
By: Matthew Parker, Park Services Manager

DATE: May 1, 2024

**SUBJECT: CONSIDERATION AND APPROVAL OF DESIGN
OPTION FOR THE COMMUNITY CENTER
AUDITORIUM STAGE ADA IMPROVEMENTS**

SUMMARY

In the approved FY 2023-2024 Budget, an allocation of approximately \$621,769 from Quimby fee funds originating from the Crestview, KB Homes, and Fairfield LLC projects has been earmarked for specific Capital Improvement Projects (CIP) at the Community Center Campus. The enhancements encompass a range of endeavors, such as achieving ADA compliance for the Senior Center restrooms, advancements to the Community Center Auditorium stage, and implementing Audio/Visual upgrades for the Senior Center and Room 6. All of these initiatives fall within the confines of the allocated budget. The initial plans for the Auditorium ADA upgrades encompass the integration of an ADA-compliant wheelchair lift onto the stage and making necessary modifications to ensure ADA access compliance for the Senior Center's restroom facilities.

BACKGROUND

The Auditorium and the Senior Center were both originally built in 1968, however; in 1982, an addition was built onto the Senior Center to increase building capacity and better serve the growing community. Both the Auditorium stage and Senior Center restrooms are of original design building standards from when they were constructed before the ADA was passed in 1990 and are out of compliance with ADA accessibility standards.

At the regular November 2023 Board Meeting, the Board approved Staff's recommendation to enter into a professional services agreement with Lauterbach & Associates, Inc. for Architectural Design Services. Staff met with architects Mark Petit and Everett Scofield onsite to discuss the objective and scope of the project. Staff provided the direction for the architects to focus on providing design options for ADA compliance issues surrounding accessibility to the Auditorium stage, stage dressing rooms, and associated restrooms as well as the Senior Center's restrooms.

The design options were then presented to the Board of Directors at the regular January 2024 Board meeting to select the options for the Lauterbach design team to proceed with developing plans and construction documents. The Board selected to move forward with reconfiguring the restrooms in both the Auditorium dressing rooms/restrooms and the Senior Center restrooms. However, the Board expressed the necessity for additional information and instructed staff to collaborate with the Lauterbach team to obtain construction cost estimates for various options regarding the ADA wheelchair lift for the Auditorium stage.

ANALYSIS

Per Board's direction at the March meeting, Lauterbach has provided the following four options for the Auditorium Stage ADA wheelchair lift. The table below lists the costs associated with design, engineering, demolition, and construction for each of the three-stage wheelchair lift options.

<i>Designs found in Attachment #1; Pricing found in Attachment #2:</i>		
Options	Description	Cost
1 <i>"Basic"</i>	Basic design showing the wheelchair lift simply bolted to the concrete subfloor and stage. <ul style="list-style-type: none">• This is probably the most economical option.	\$53,650
2 <i>"Bulb-outs"</i>	Matching Bulb-outs on both stage-left and stage-right with the lift incorporated in the stage-left bulb-out (Option 2, page 1). <ul style="list-style-type: none">• Identified on pages 2 & 3• This option would look more intentional and less conspicuous.	\$78,350
3 <i>"Stair Removal"</i>	Demolishing the stage-left stairs and their replacement with the wheelchair lift. <ul style="list-style-type: none">• With this option, the stair access would be lost and has the most unknown potential for additional engineering and structural work to move a wall and incorporate it into the existing architecture above the stage.	\$91,300
4 <i>"Incline Stair lift"</i>	Installation of an incline stair wheelchair lift to the existing stage left stage With this option, the stair access would remain and would be accessible when the lift isn't in use and would offer a higher level privacy to the user. Also, this option would require the least amount of structural modifications.	\$45,000

FISCAL IMPACT

There is minimal fiscal impact as it relates to the design and engineering of this project with the Board action on this item. However, depending on the option selected, there will be an estimated \$25,000 to \$50,000 delta for demolition and construction once the construction phase of the project is completed.

STRATEGIC PLAN COMPLIANCE

Meets 2021 Strategic Plan Goals and Strategies:

- **2.1.D:** Identify features and amenities within the existing Community Center facility to be updated or improved (Fire Codes /ADA/etc.) as part of the larger project.

- **3.2.F:** Develop, communicate, and begin implementation of an Americans with Disabilities Act (ADA) Transition Plan.

RECOMMENDATION

It is recommended the Board of Directors consider and recommend a design option for Staff to provide direction to staff and the Lauterbach & Associates, Inc. team for the Community Center Auditorium ADA Stage improvements.

ATTACHMENTS

- 1) Lauterbach & Associates Inc. Lift Design Sketches (4 pages)
- 2) Lauterbach & Associates Inc. Lift Cost Estimates (4 pages)

XPRESS II INCLINED PLATFORM LIFT:

Note: The supporting structure must withstand the loads and forces exerted by the lift, as shown on the loading diagram. Consult a local structural engineer to confirm suitability.

Code Reference: ASME A18.1.2003 "Safety Standard for Platforms Lifts and Stairway Chairlifts"

Emergency Devices: Emergency stop switch on a control panel, under platform sensing, ramp sensing and grab rail.

Safeties: Overspeed governor on upper carriage drive, containing mechanical overspeed sensor and lock, with electrical drive cut-out protection.

Drive: Power Transmission: Worm gear reduction to a pinion moving on a fixedgear rack.

Motor: 0.75 HP

Power Supply: 208-240 VAC / 1 PHASE - 50/60 Hz, on a dedicated 20 amp circuit.

Travel Speed: 4 m/min [13 ft/min] traveling up; 5 m/min [16 ft/min] traveling down.

Location: Indoor Lift

Attachment: Direct Mount Unit with 3x3x1/4" [76 x 76 x 6 mm] Steel Posts in Wall

Platform: 800mm x 1250mm [31 1/2" x 49 1/4"] (Keyless)
The 16 ga. galvanized platform deck is finished with an electrostatically applied Non-Slip Black Sandex powder coat. The platform is equipped with a grab rail, hour counter and retractable passenger restraining arms.

Capacity: Maximum 250 kg [550 lb] operating load.



Color: Upper and lower rails and loading ramps are made of aluminum extrusions. The aluminium and steel components of the lift are finished with an electrostatically applied and baked powder 'Silver Moon' finish.

Ramps: Lower Ramp - Standard 185mm [7.25"]
Upper Ramp - Standard 185mm [7.25"]
Sideload - Not Required.

Call Stations: Lower Landing - Surface Mount c/w flush adapter (Keyed / Keyless - configurable)
Upper Landing - Surface Mount c/w flush adapter (Keyed / Keyless - configurable)

Custom Work: None.

Optional Items: Handrail, Fold Down Seat Kit, In-Hanger Alarm with Battery Back-up, Auxiliary Power System.

A	INITIAL RELEASE	UNITS: INCHES	APR 16/24	LA	
REV.	SCALE: NTS	TOLERANCES: DIMENSIONAL ±1/16" ANGULAR ±0.5°	PROJECTION: 	DATE	DRN.BY
		XPRESS II CONCEPT DRAWING CAMARILLO COMMUNITY CENTER 1605 BURNLEY ST CAMARILLO CA 93013			XI966-CI-A
		PAGE 1 OF 4 MCKINLEY ELEVATOR CORPORATION (CA)			

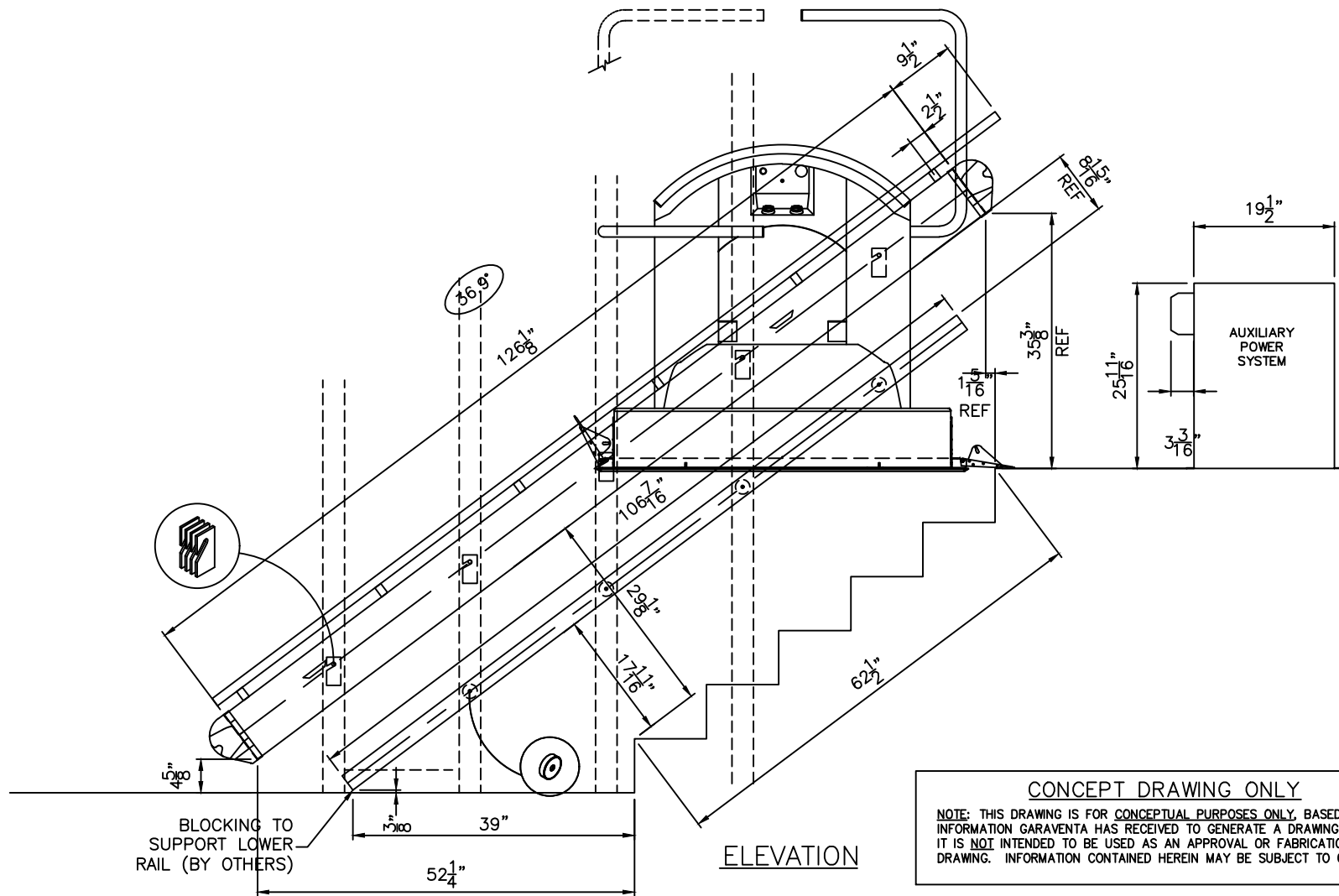

CONCEPT DRAWING ONLY

NOTE: THIS DRAWING IS FOR CONCEPTUAL PURPOSES ONLY, BASED ON INFORMATION GARAVENTA HAS RECEIVED TO GENERATE A DRAWING. IT IS NOT INTENDED TO BE USED AS AN APPROVAL OR FABRICATION DRAWING. INFORMATION CONTAINED HEREIN MAY BE SUBJECT TO CHANGE.

STAIR INFORMATION:
 HORIZONTAL: 50"
 VERTICAL: 37 1/2"
 SLOPE: 62 1/2"
 FIRST RISER: 7 1/2"
 UNIT SIDE: LEFT
 # OF RISERS: 6
 STAIR ANGLE: 36.9°

A	INITIAL RELEASE	UNITS: INCHES	APR 16/24	LA		
REV.	SCALE: NTS	TOLERANCES: DIMENSIONAL ±1/16" ANGULAR ±0.5°	PROJECTION:	DATE	DRN.BY	
		XPRESS II CONCEPT DRAWING CAMARILLO COMMUNITY CENTER 1605 BURNLEY ST CAMARILLO CA 93013				XI 966-CI-A
		PAGE 2 OF 4				
		MCKINLEY ELEVATOR CORPORATION (CA)				

⚡ DEDICATED CIRCUIT SUPPLIED BY OTHERS:
 208-240 VAC / 1 PHASE - 50/60 Hz.
 Conduit and devices to suit local codes and
 a recommended 20 amp. dedicated circuit.

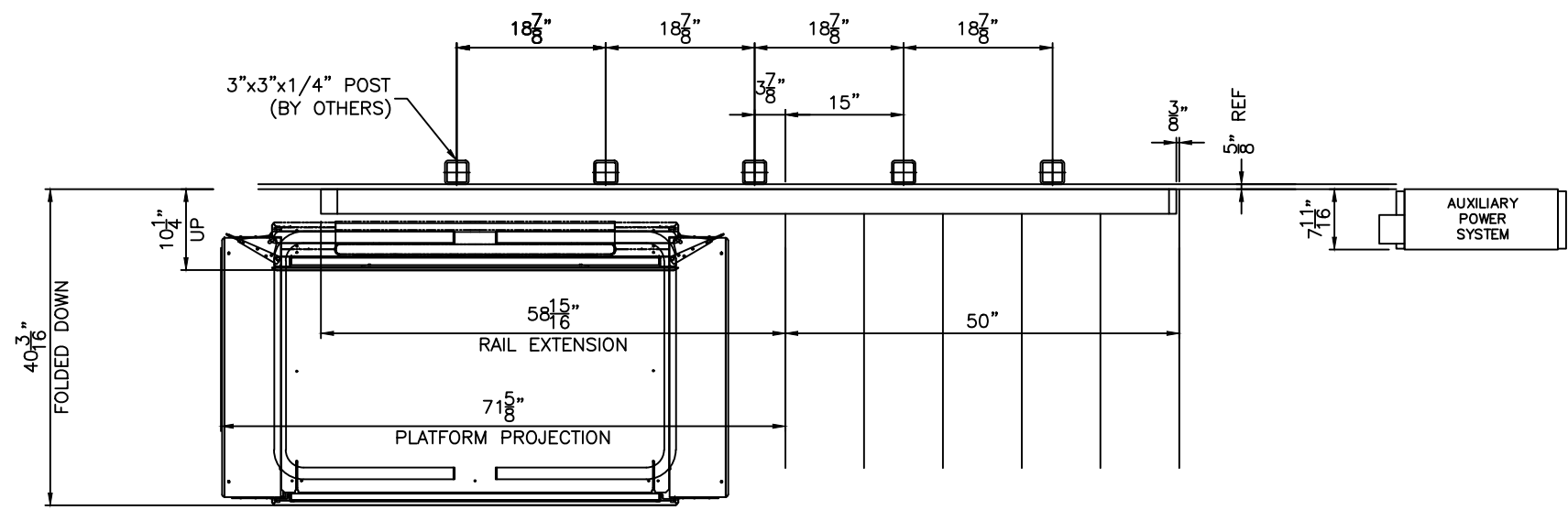

PLAN DIRECT MOUNT UNIT

CONCEPT DRAWING ONLY
 NOTE: THIS DRAWING IS FOR CONCEPTUAL PURPOSES ONLY, BASED ON
 INFORMATION GARAVENTA HAS RECEIVED TO GENERATE A DRAWING.
 IT IS NOT INTENDED TO BE USED AS AN APPROVAL OR FABRICATION
 DRAWING. INFORMATION CONTAINED HEREIN MAY BE SUBJECT TO CHANGE.

A	INITIAL RELEASE	UNITS: INCHES	APR 16/24	LA	
REV.	SCALE: NTS	TOLERANCES: DIMENSIONAL ±1/16" ANGULAR ±0.5°	PROJECTION:	DATE	DRN.BY
		XPRESS II CONCEPT DRAWING CAMARILLO COMMUNITY CENTER 1605 BURNLEY ST CAMARILLO CA 93013			XI 966-CI-A
		PAGE 3 OF 4 MCKINLEY ELEVATOR CORPORATION (CA)			

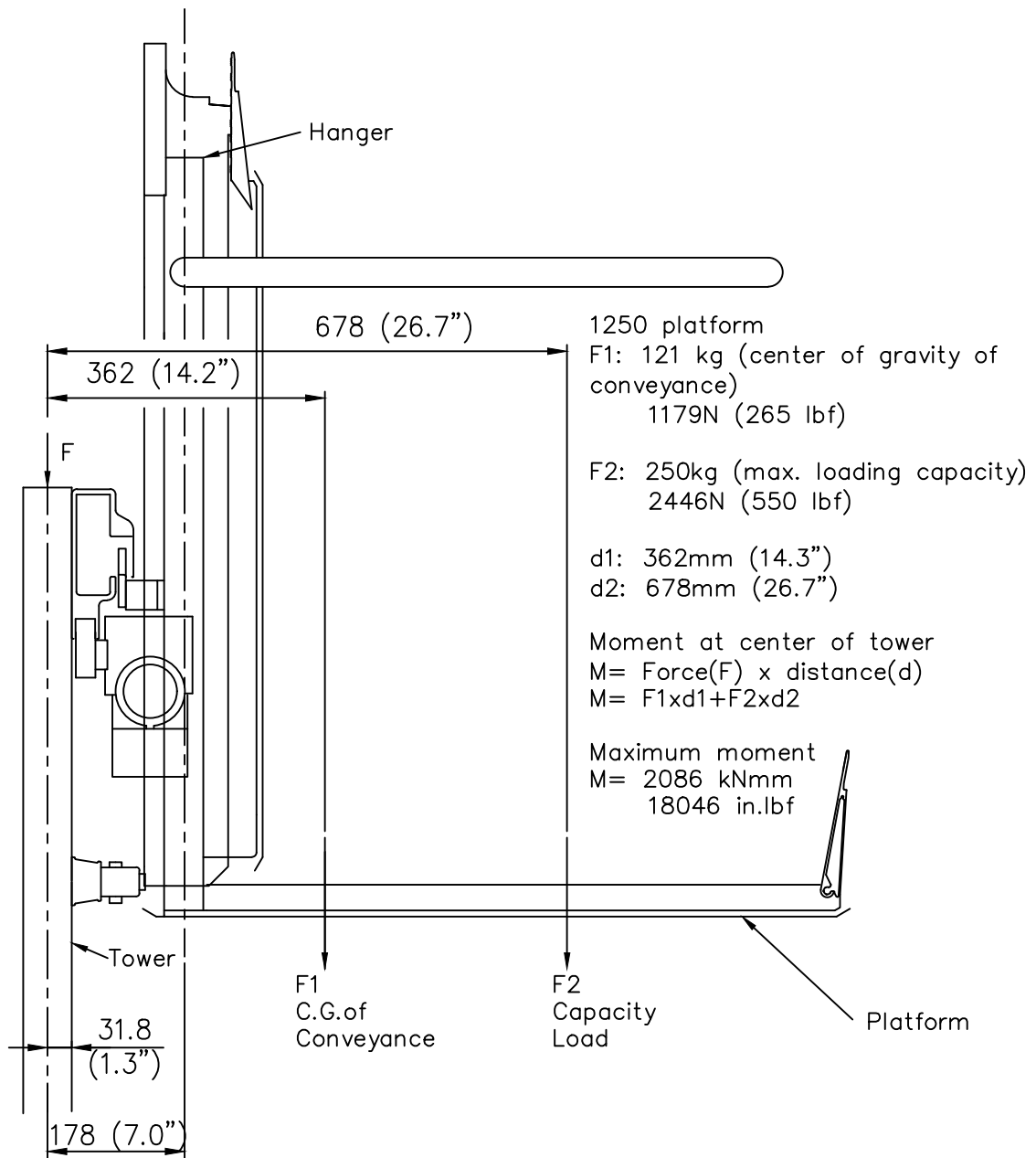

LOADING DIAGRAM

N.T.S.

A	INITIAL RELEASE	UNITS: INCHES	APR 16/24	LA	
REV.	SCALE: NTS	TOLERANCES: DIMENSIONAL ±1/16" ANGULAR ±0.5°	PROJECTION:	DATE	DRN.BY
		XPRESS II CONCEPT DRAWING CAMARILLO COMMUNITY CENTER 1605 BURNLEY ST CAMARILLO CA 93013			X1966-CI-A
		PAGE 4 OF 4 MCKINLEY ELEVATOR CORPORATION (CA)			



COMPANY: Lauterbach & Associates Architects
 ATTN: Everett Scofield
 JOB BIDDING: Camarillo Community Center
 BID DATE: April 17, 2024
 BID NUMBER: 00066906
 BID ON: Wheelchair Lift

<u>SECTION</u>	<u>QTY</u>	<u>EQUIPMENT AND MANUFACTURER</u>	<u>BID PRICE</u>
14420	1	Garaventa Xpress II Incline Wheelchair Lift	

TOTAL PRICE INSTALLED, SALES TAX INCLUDED **\$45,000.00**

OPTIONS:

- 1. Battery Back Up..... INCLUDED
- 2. For Custom Color.....ADD \$2,000.00

CONTRACTORS LICENSE # 861406
CALIFORNIA SB 854 # PW-LR-1000369784
ADDENDUMS NOTED: NONE
EQUAL TO PLANS AND SPECS: Specified Brand

EXCLUSIONS:

- 1. All local permits, seismic calculations and bonds.
- 2. Liquidated damages, if applicable.
- 4. All conduit runs, control wires, "J" boxes and remote fusible, lockable disconnect for electrical controls and power.
- 5. Signage and site preparation
- 6. Remote alarm, and/or telephone, if required.
- 7. Overhead lighting.

NOTES:

- 1. Terms of payment: 50% prior to initiating order, 40% due prior to factory shipment, 10% due at day and place of inspection; no retention. Contract subject to credit approval and checks due in full on identified days of terms. **Bid price includes THREE site visits (pre-install, install, inspection). Additional site mobilizations will be at extra cost.**
- 2. **State certification required of subcontractor and technician.**

17811 Armstrong Avenue
 Irvine, California 92614
 949/261-9244
 FAX 949/955-3875

www.mckinleyelevator.com

28301 Industrial Blvd., Suite 9
 Hayward, California 94545
 510/300-1599
 FAX 510/259-1375

Sacramento • Las Vegas • Phoenix

3. Costs included are **only** for **initial Elevator Division Permit Fee and Inspection**. **Any additional charges or fees that may be required will be added at owner's expense.**
4. A certificate of insurance with a limit of \$2 million comprehensive will be furnished.
5. Electrical work – Electrician brings power to runway disconnect on our lift. Electrician provides fusible, lockable remote disconnect. Electrician runs low voltage wires in conduit with pull cords installed by electrician. McKinley will twist wires at the request of the electrician, but electrician must approve hook-up and low voltage wiring as being in accordance with local codes, accept wiring as his own work, and have it on his permit. McKinley furnishes wiring and conduit diagrams. Remote alarm, if required, by others.
6. Labor to be non-union during normal business hours.
7. Installation must be scheduled after conduit is in place, when we will have clear access to work area and power is available for equipment operation, adjustment and testing.
8. Factory shipment is 4-6 weeks after receipt of approved shop drawings, approved by architect, and jobwalk.
9. Price quote valid for 30 days, based on material delivery within 180 days.
10. 35% charged for orders cancelled prior to manufacture. 100% of contract due for cancellation after start of manufacture.
11. Pricing subject to change from factory material increases, labor cost increases, or lengthened installation times beyond 180 days.
12. Contract subject to credit approval and terms in Attachment "A", which follows.
13. **The notes and exclusions stated in our bid must be made part of the contract or the above price is not valid**
14. McKinley reserves the right to photograph/brochure/advertise the completed product after jobsite installation.

TERMS AND CONDITIONS

1. This proposal is valid for 30 days from the date of issue. If not accepted by buyer within 30 days, this proposal is void.
2. Orders will be filled in accordance with local building requirements. Buyer shall be solely responsible to determine and communicate to seller all applicable building requirements, codes and ordinances. All sales and excise taxes in respect to manufacture, sale, transportation, or delivery are for the account of the buyer and shall be paid by the buyer. All bonds or permits shall be buyer's responsibility.
3. Seller shall not be liable for any loss or damages to buyer resulting from delays in production or delivery attributable to equipment manufacturer(s), transportation or other causes beyond the reasonable control of seller.
4. Seller reserves the right at seller's option to repair or replace or credit the price of defective or nonconforming goods which have been duly rejected and returned, transportation charges prepaid, and which have not been altered or defaced or further processed in any way after delivery, but under no circumstances will seller be responsible or liable for loss, damage or expense growing out of defective or nonconforming goods or the use thereof or other consequential damages. No goods will be accepted for return, replacement or credit without the written consent of seller.
5. Once an order has been placed hereunder, buyer may not cancel, alter, change or delay the order or the time of delivery therefore, except with seller's written consent. Buyer shall be responsible for all of seller's additional costs including, but not limited to, increased material costs, storage charges, delay damages or any job related costs which may be imposed against buyer or seller as a result of the change in the order.
6. Production, shipment and delivery shall at all times be subject to the approval of seller's credit department. In case of doubt as to buyer's responsibility, seller may defer production and may decline to make shipment except under conditions satisfactory to seller.
7. The determination as to whether an architect, engineer or manufacturer's design and/or specifications will be suitable for use in a specific job is the sole responsibility of buyer.

8. Limitation of Liability: Neither seller, any manufacturer whose products are the subject of this transaction, nor any representative of seller shall in any event be liable for any loss of the use of any equipment or incidental or consequential damages of any kind whether for breach of warranty, negligence or strict liability. In the event buyer believes seller is in default or has failed to perform any of seller's obligations hereunder, buyer shall provide seller with not less than seven (7) days written notice prior to making any repairs, altering the equipment or its installation, completing any remaining work or terminating this agreement.
9. Seller disclaims any express or implied warranties hereunder including, but not limited to, any implied warranty of merchantability or fitness for a particular use or purpose. The only warranty hereunder in favor of buyer shall be any warranty by any manufacturer of equipment being purchased hereunder.
10. In the event buyer fails to make payment, seller may enter into any premises where the equipment purchased hereunder may be located and without liability therefore and disable and/or repossess the equipment. Seller shall not be responsible for any loss or damages to buyer or any third parties, which results from seller's disabling or repossessing the equipment. Seller may retain or dispose the repossessed property as its own. Seller may hold said property for the account of buyer and dispose thereof without notice at public or private sale at which seller may bid and become buyer of the property. In the event of such sale for the account of buyer all payments previously made and any proceeds of such sale after deducting the reasonable expenses of such repossession and sale including reasonable attorney's fees, shall be applied in reduction of the total indebtedness hereunder and the buyer shall be liable for any deficiency for breach of this contract.
11. In the event either party is required to enforce its rights under this agreement, whether by suit or arbitration, the prevailing party shall be entitled to its reasonable, but not less than its actual, attorneys' fees, costs and related expenses. In the event of buyer's default hereunder, in addition to any other relief to which seller may be entitled, buyer agrees to pay seller interest, in the form of a late service charge, at the rate of 2% per month.
12. This agreement constitutes the entire understanding and agreement between the parties hereto with respect to the matters referred to herein. No other representations, or other prior or contemporaneous agreements, oral or written, respecting such matters, which are not specifically included herein, shall be deemed in any way to exist or bind the parties hereto. In the event of any conflict or inconsistency between the terms and conditions of buyer's purchase order and the terms and conditions of this agreement, the terms and conditions of this agreement shall govern. This agreement shall be construed as if both parties jointly prepared it and any uncertainty or ambiguity will not be interpreted against any one party. In the event any provision of this agreement shall be void or unenforceable, the same shall in no way affect any other provision hereto, the application of such provision in or to any other circumstance(s) or the validity or enforceability of this agreement as a whole.
13. In the event there is a balance owed hereunder that falls within the jurisdiction of the small claims Court, then, in that event only, and at the sole option of seller, any action commenced hereunder shall be commenced in the County of Orange, State of California. Seller shall not be bound by any provision requiring arbitration in any agreement between the buyer and any third party.
14. Seller reserves the right to remove and retain all material and apparatus that has been replaced or new materials not used in construction

McKINLEY ELEVATOR CORPORATION

Randy Weiler CELL: (949) 293-5121 EMAIL: randy.weiler@mckinleyelevator.com

Name: Everett Scofield
Phone: (805) 988-0912
Email: everett.scofield@la-arch.com



Accepted By (Signature)

(Print Name)

Title

Date

Company and/or Owner

Contractor License #

**PLEASANT VALLEY RECREATION AND PARK DISTRICT
STAFF REPORT / AGENDA REPORT**

TO: BOARD OF DIRECTORS

FROM: MARY OTTEN, GENERAL MANAGER
By: Jennifer Strain, Administrative Analyst

DATE: May 1, 2024

**SUBJECT: APPROVAL OF A FIRST READING FOR THE
ADOPTION OF ORDINANCE NO. 14, AN ORDINANCE
OF THE BOARD OF DIRECTORS OF THE PLEASANT
VALLEY RECREATION AND PARK DISTRICT
SETTING BOARD MEMBER COMPENSATION**

SUMMARY

Approval of this first reading will allow for the adoption of Ordinance No. 14, an ordinance that sets Board Member compensation. The District is obligated to comply with several Government codes, in particular the Public Resource Code Section 5784.15. Each Board Member of the Board of Directors may receive per diem compensation for each day of service rendered, together with expenses, subject to limits set forth by the law.

BACKGROUND

The District is obligated to comply with several Government codes, in particular the Public Resource Code Section 5784.15. Each Board Member of the Board of Directors may receive per diem compensation for each day of service rendered, together with expenses, subject to limits set for by the law. Within these sections, the code requires that special districts establish policies and procedures for the orderly and efficient operation of Board business.

At the November 3, 2022 Board meeting, the Board of Directors adopted Ordinance No. 13, setting District Board member compensation at \$115.75 per meeting, not to exceed 5 meetings per month.

Pursuant to Public Resources Code 5784.15 and Water Code 20202, the District Board may increase the daily compensation by no more than five (5) percent for each calendar year following the operative date of the last adjustment, of the compensation which is received when the ordinance is adopted.

ANALYSIS

The attached Ordinance has been reviewed by the District's counsel and has been approved to form. The purpose of this ordinance is to specifically raise the compensation rate for Directors by five (5) percent rounded to the lowest five (5) cent increment to \$121.50 per meeting. This ordinance is required to be approved after a public hearing and takes effect 30 days after the second reading. Additionally, this ordinance replaces Ordinance No. 13 in its entirety.

FISCAL IMPACT

District staff anticipates that with an approval of a five (5) percent increase to days of service compensation, a maximum compensation increase of \$1,725.00 is expected.

RECOMMENDATION

It is recommended that the Board review and introduce Ordinance No. 14 by:

1. Making a MOTION to read the complete Ordinance No. 14 title – *Ordinance No. 14, An Ordinance of The Board of Directors of The Pleasant Valley Recreation and Park District Setting Board Member Compensation* and to waive further reading;

AND

2. Making a MOTION to APPROVE the introduction and first reading of the District's *Ordinance No. 14, An Ordinance of The Board of Directors of The Pleasant Valley Recreation and Park District Setting Board Member Compensation.*

ATTACHMENTS

- 1) Ordinance No. 14 – Board Compensation (2 pages)
- 2) Public Hearing Notice - Ordinance No. 14 (1 page)

ORDINANCE NO. 14

AN ORDINANCE OF THE BOARD OF DIRECTORS OF THE PLEASANT VALLEY RECREATION AND PARK DISTRICT SETTING BOARD MEMBER COMPENSATION

WHEREAS, on November 3, 2022, the Board adopted Ordinance No 13 pursuant to Public Resources Code Section 5784.15 and Water Code Sections 20201 and 20202 to set the daily compensation of Board Members; and

WHEREAS, the current compensation for Directors for each day's attendance at meetings of the Board and for each day's service rendered as a Director by request of the Board, not to exceed 5 meetings or activities each month, is \$115.75; and

WHEREAS, pursuant to Public Resources Code 5784.15 and Water Code 20202 the District Board may increase the daily compensation by no more than five (5) percent for each calendar year following the operative date of the last adjustment; and

WHEREAS, the Board desires to adjust Board Member compensation as permitted under State law; and

WHEREAS, this item was properly noticed for a public hearing by the Board of Directors on April XX, 2024 and April XX, 2024.

THE BOARD OF DIRECTORS OF THE PLEASANT VALLEY RECREATION AND PARK DISTRICT ORDAIN AS FOLLOWS:

SECTION 1. – The recitals above are true and correct and incorporated herein by reference.

SECTION 2. – Permitted Compensation

- A. The amount of compensation payable to each Director for each day's attendance at meetings of the Board and for each day's service rendered as a Director by request of the Board is increased to \$121.50 as of compensation payable for July 2024.
- B. Directors may not receive compensation for services rendered for more than a total of 5 days in any calendar month per Public Resources Code Section 5784.15.
- C. In addition to daily compensation authorized in subsection A, the Board authorizes the reimbursement of any actual costs, per Resolution No. 583, incurred by a Director when rendering services as a Director by request of the Board.

SECTION 3. – Future Adjustments to Compensation. Any future increases in compensation for Directors must be approved by an ordinance of the Board and the increase may not exceed the amount permitted by State law since the last increase.

SECTION 4. – This Ordinance will become effective 30 days from the date of adoption.

SECTION 5. – Upon the effective date of this ordinance, Ordinance No. 13 shall no longer be in effect.

SECTION 6. – The Clerk of the Board of Directors shall certify to the passage of this Ordinance and cause the same to be posted and published in accordance with law.

PASSED AND ADOPTED this 5th day of June 2024, by the following vote:

AYES: _____

NOES: _____

ABSENT: _____

ABSTAIN: _____

Mark Malloy, Chairman, Board of Directors
Pleasant Valley Recreation and Park District

ATTESTED:

Jordan Roberts, Secretary, Board of Directors
Pleasant Valley Recreation and Park District

NOTICE OF PUBLIC HEARING FOR THE PLEASANT VALLEY RECREATION AND PARK DISTRICT

NOTICE IS HEREBY GIVEN that the Board of Directors of the Pleasant Valley Recreation and Park District intends to conduct a public hearing for the purpose of approving District Ordinance No. 14, an ordinance of the Pleasant Valley Recreation and Park District Governing Board Member Compensation.

The public hearing shall be held on Wednesday, May 1, 2024, at 6:00 p.m.

Members of the public are invited to provide comments at the public hearing, or, in writing, which is received by the District on or before Wednesday, May 1, 2024, by 2:00 p.m. If you desire additional information concerning the above, please contact Pleasant Valley Recreation and Park District at (805) 482-1996 ext. 110.

Dated April 12, 2024

Pleasant Valley Recreation and Park District

Mark Malloy

CHAIR, BOARD OF DIRECTORS

Publish: April 20, 2024

9. ORAL COMMUNICATION - INFORMATIONAL ITEMS, which do not require action but relate to District business, will be reported by members of the Board and staff as follows:

- A. Chair Malloy
- B. Ventura County/California Special District Association
- C. Santa Monica Mountains Conservancy
- D. Standing Committees – Finance, Policy
- E. Foundation for Pleasant Valley Recreation and Parks
- F. General Manager’s Report
- G. Board Members